

1982



Information Manual

Skyhawk

Model 172P

Notes: _____

NOTICE

AT THE TIME OF ISSUANCE, THIS INFORMATION MANUAL WAS AN EXACT DUPLICATE OF THE OFFICIAL PILOT'S OPERATING HANDBOOK AND FAA APPROVED AIRPLANE FLIGHT MANUAL AND IS TO BE USED FOR GENERAL PURPOSES ONLY.

IT WILL NOT BE KEPT CURRENT AND, THEREFORE, CANNOT BE USED AS A SUBSTITUTE FOR THE OFFICIAL PILOT'S OPERATING HANDBOOK AND FAA APPROVED AIRPLANE FLIGHT MANUAL INTENDED FOR OPERATION OF THE AIRPLANE.

**CESSNA AIRCRAFT COMPANY
12 MAY 1981**

PERFORMANCE-
SPECIFICATIONS

CESSNA
MODEL 172P

PERFORMANCE - SPECIFICATIONS

SPEED:	
Maximum at Sea Level	123 KNOTS
Cruise, 75% Power at 8000 Ft	120 KNOTS
CRUISE: Recommended lean mixture with fuel allowance for engine start, taxi, takeoff, climb and 45 minutes reserve.	
75% Power at 8000 Ft	440 NM
40 Gallons Usable Fuel	3.8 HRS
75% Power at 8000 Ft	585 NM
50 Gallons Usable Fuel	5.0 HRS
75% Power at 8000 Ft	755 NM
62 Gallons Usable Fuel	6.4 HRS
Maximum Range at 10,000 Ft	520 NM
40 Gallons Usable Fuel	5.6 HRS
Maximum Range at 10,000 Ft	680 NM
50 Gallons Usable Fuel	7.4 HRS
Maximum Range at 10,000 Ft	875 NM
62 Gallons Usable Fuel	9.4 HRS
RATE OF CLIMB AT SEA LEVEL	700 FPM
SERVICE CEILING	13,000 FT
TAKEOFF PERFORMANCE:	
Ground Roll	890 FT
Total Distance Over 50-Ft Obstacle	1625 FT
LANDING PERFORMANCE:	
Ground Roll	540 FT
Total Distance Over 50-Ft Obstacle	1280 FT
STALL SPEED (KCAS):	
Flaps Up, Power Off	51 KNOTS
Flaps Down, Power Off	46 KNOTS
MAXIMUM WEIGHT:	
Ramp	2407 LBS
Takeoff or Landing	2400 LBS
STANDARD EMPTY WEIGHT:	
Skyhawk	1427 LBS
Skyhawk II	1454 LBS
MAXIMUM USEFUL LOAD:	
Skyhawk	980 LBS
Skyhawk II	953 LBS
BAGGAGE ALLOWANCE	
	120 LBS
WING LOADING: Pounds/Sq Ft	
	13.8
POWER LOADING: Pounds/HP	
	15.0
FUEL CAPACITY: Total	
Standard Tanks	43 GAL.
Long Range Tanks	54 GAL.
Integral Tanks	68 GAL.
OIL CAPACITY	
	8 QTS
ENGINE: Avco Lycoming	
160 BHP at 2700 RPM	O-320-D2J
PROPELLER: Fixed Pitch, Diameter	
	75 IN.

The above performance figures are based on the indicated weights, standard atmospheric conditions, level hard-surface dry runways, and no wind. They are calculated values derived from flight tests conducted by the Cessna Aircraft Company under carefully documented conditions and will vary with individual airplanes and numerous factors affecting flight performance.

INFORMATION MANUAL

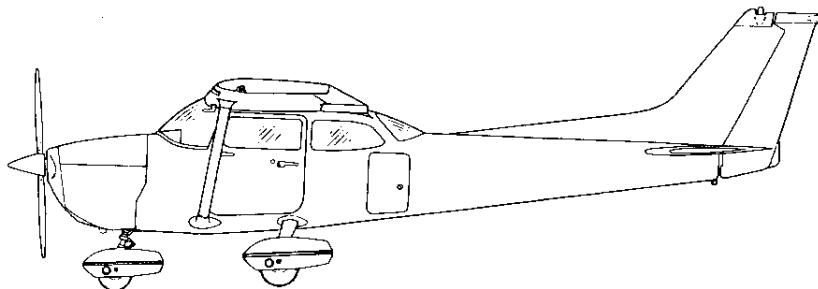

CESSNA AIRCRAFT COMPANY

1982 MODEL 172P

THIS MANUAL INCORPORATES INFORMATION ISSUED
THRU REVISION 2 TO THE PILOT'S OPERATING HAND-
BOOK AND FAA APPROVED AIRPLANE FLIGHT MANUAL
DATED 1 OCTOBER 1994.

COPYRIGHT © 1995

Cessna Aircraft Company

Wichita, Kansas USA

 Member of GAMA

D1212-13-RGI-2000-8/95

iii/(iv blank)

Notes: _____

TABLE OF CONTENTS

	SECTION
GENERAL.....	1
LIMITATIONS.....	2
EMERGENCY PROCEDURES.....	3
NORMAL PROCEDURES.....	4
PERFORMANCE.....	5
WEIGHT & BALANCE/ EQUIPMENT LIST	6
AIRPLANE & SYSTEMS DESCRIPTIONS	7
AIRPLANE HANDLING, SERVICE & MAINTENANCE	8
SUPPLEMENTS (Optional Systems Description & Operating Procedures)	9

Notes: _____

SECTION 1 GENERAL

TABLE OF CONTENTS

	Page
Three View	1-2
Introduction	1-3
Descriptive Data	1-3
Engine	1-3
Propeller	1-3
Fuel	1-3
Oil	1-4
Maximum Certificated Weights	1-5
Standard Airplane Weights	1-5
Cabin And Entry Dimensions	1-5
Baggage Space And Entry Dimensions	1-5
Specific Loadings	1-5
Symbols, Abbreviations And Terminology	1-6
General Airspeed Terminology And Symbols	1-6
Meteorological Terminology	1-6
Engine Power Terminology	1-7
Airplane Performance And Flight Planning Terminology	1-7
Weight And Balance Terminology	1-8

SECTION 1
GENERAL

CESSNA
MODEL 172P

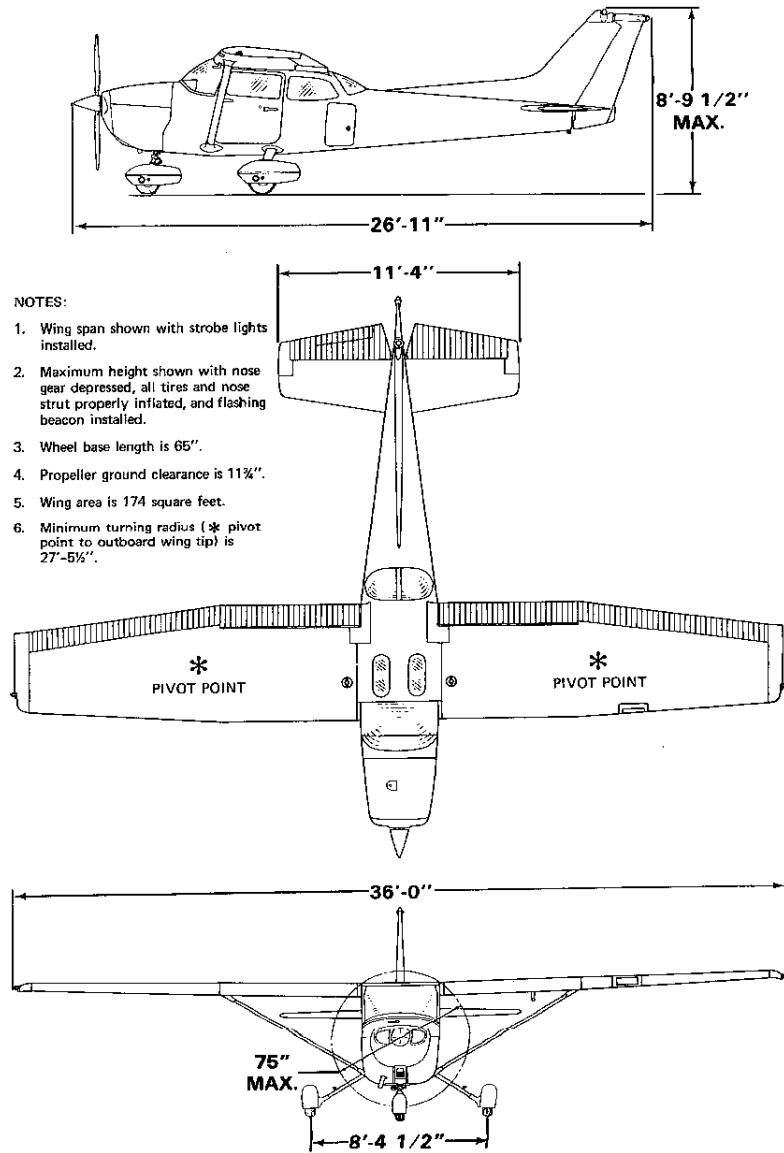

Figure 1-1. Three View

INTRODUCTION

This handbook contains 9 sections, and includes the material required to be furnished to the pilot by CAR Part 3. It also contains supplemental data supplied by Cessna Aircraft Company.

Section 1 provides basic data and information of general interest. It also contains definitions or explanations of symbols, abbreviations, and terminology commonly used.

DESCRIPTIVE DATA

ENGINE

Number of Engines: 1.
Engine Manufacturer: Avco Lycoming.
Engine Model Number: O-320-D2J.
Engine Type: Normally-aspirated, direct-drive, air-cooled, horizontally-opposed, carburetor equipped, four-cylinder engine with 319.8 cu. in. displacement.
Horsepower Rating and Engine Speed: 160 rated BHP at 2700 RPM.

PROPELLER

Propeller Manufacturer: McCauley Accessory Division.
Propeller Model Number: 1C160/DTM7557.
Number of Blades: 2.
Propeller Diameter, Maximum: 75 inches.
Minimum: 74 inches.
Propeller Type: Fixed pitch.

FUEL

Approved Fuel Grades (and Colors):
100LL Grade Aviation Fuel (Blue).
100 (Formerly 100/130) Grade Aviation Fuel (Green).

NOTE

Isopropyl alcohol or ethylene glycol monomethyl ether may be added to the fuel supply. Additive concentrations shall not exceed 1% for isopropyl alcohol or .15% for ethylene glycol monomethyl ether. Refer to Section 8 for additional information.

SECTION 1
GENERAL

CESSNA
MODEL 172P

Fuel Capacity:

Standard Tanks:

Total Capacity: 43 gallons.
Total Capacity Each Tank: 21.5 gallons.
Total Usable: 40 gallons.

Long Range Tanks:

Total Capacity: 54 gallons.
Total Capacity Each Tank: 27 gallons.
Total Usable: 50 gallons.

Integral Tanks:

Total Capacity: 68 gallons.
Total Capacity Each Tank: 34 gallons.
Total Usable: 62 gallons.

NOTE

To ensure maximum fuel capacity when refueling and minimize cross-feeding when parked on a sloping surface, place the fuel selector valve in either LEFT or RIGHT position.

OIL

Oil Grade (Specification):

MIL-L-6082 Aviation Grade Straight Mineral Oil: Use to replenish supply during first 25 hours and at the first 25-hour oil change. Continue to use until a total of 50 hours has accumulated or oil consumption has stabilized.

MIL-L-22851 Ashless Dispersant Oil: This oil **must be used** after first 50 hours or oil consumption has stabilized.

Recommended Viscosity for Temperature Range:

MIL-L-6082 Aviation Grade Straight Mineral Oil:

All temperatures, use SAE 20W-50 or
Above 16°C (60°F), use SAE 50
-1°C (30°F) to 32°C (90°F), use SAE 40
-18°C (0°F) to 21°C (70°F), use SAE 30
Below -12°C (10°F), use SAE 20

MIL-L-22851 Ashless Dispersant Oil:

All temperatures, use SAE 20W-50 or
Above 16°C (60°F), use SAE 40 or SAE 50
-1°C (30°F) to 32°C (90°F), use SAE 40
-18°C (0°F) to 21°C (70°F), use SAE 40 or SAE 30
Below -12°C (10°F), use SAE 30

Oil Capacity:

Sump: 7 Quarts.
Total: 8 Quarts.

MAXIMUM CERTIFICATED WEIGHTS

Ramp, Normal Category: 2407 lbs.
Utility Category: 2107 lbs.
Takeoff, Normal Category: 2400 lbs.
Utility Category: 2100 lbs.
Landing, Normal Category: 2400 lbs.
Utility Category: 2100 lbs.
Weight in Baggage Compartment, Normal Category:
Baggage Area 1 (or passenger on child's seat) - Station 82 to 108; 120 lbs. See note below.
Baggage Area 2 - Station 108 to 142: 50 lbs. See note below.

NOTE

The maximum combined weight capacity for baggage areas 1 and 2 is 120 lbs.

Weight in Baggage Compartment, Utility Category: In this category, the baggage compartment and rear seat must not be occupied.

STANDARD AIRPLANE WEIGHTS

Standard Empty Weight, Skyhawk: 1427 lbs.
Skyhawk II: 1454 lbs.

Maximum Useful Load:

	Normal Category	Utility Category
Skyhawk:	980 lbs.	680 lbs.
Skyhawk II:	953 lbs.	653 lbs.

CABIN AND ENTRY DIMENSIONS

Detailed dimensions of the cabin interior and entry door openings are illustrated in Section 6.

BAGGAGE SPACE AND ENTRY DIMENSIONS

Dimensions of the baggage area and baggage door opening are illustrated in detail in Section 6.

SPECIFIC LOADINGS

Wing Loading: 13.8 lbs./sq. ft.
Power Loading: 15.0 lbs./hp.

SYMBOLS, ABBREVIATIONS AND TERMINOLOGY

GENERAL AIRSPEED TERMINOLOGY AND SYMBOLS

KCAS	Knots Calibrated Airspeed is indicated airspeed corrected for position and instrument error and expressed in knots. Knots calibrated airspeed is equal to KTAS in standard atmosphere at sea level.
KIAS	Knots Indicated Airspeed is the speed shown on the airspeed indicator and expressed in knots.
KTAS	Knots True Airspeed is the airspeed expressed in knots relative to undisturbed air which is KCAS corrected for altitude and temperature.
V_A	Maneuvering Speed is the maximum speed at which full or abrupt control movements may be used.
V_{FE}	Maximum Flap Extended Speed is the highest speed permissible with wing flaps in a prescribed extended position.
V_{NO}	Maximum Structural Cruising Speed is the speed that should not be exceeded except in smooth air, then only with caution.
V_{NE}	Never Exceed Speed is the speed limit that may not be exceeded at any time.
V_S	Stalling Speed or the minimum steady flight speed at which the airplane is controllable.
V_{S_0}	Stalling Speed or the minimum steady flight speed at which the airplane is controllable in the landing configuration at the most forward center of gravity.
V_X	Best Angle-of-Climb Speed is the speed which results in the greatest gain of altitude in a given horizontal distance.
V_Y	Best Rate-of-Climb Speed is the speed which results in the greatest gain in altitude in a given time.

METEOROLOGICAL TERMINOLOGY

OAT	Outside Air Temperature is the free air static temperature.
-----	--

It is expressed in either degrees Celsius or degrees Fahrenheit.

Standard Temperature is 15°C at sea level pressure altitude and decreases by 2°C for each 1000 feet of altitude.

Pressure Altitude is the altitude read from an altimeter when the altimeter's barometric scale has been set to 29.92 inches of mercury (1013 mb).

ENGINE POWER TERMINOLOGY

BHP **Brake Horsepower** is the power developed by the engine.

RPM **Revolutions Per Minute** is engine speed.

Static RPM is engine speed attained during a full-throttle engine runup when the airplane is on the ground and stationary.

AIRPLANE PERFORMANCE AND FLIGHT PLANNING TERMINOLOGY

Demonstrated Crosswind Velocity is the velocity of the crosswind component for which adequate control of the airplane during takeoff and landing was actually demonstrated during certification tests. The value shown is not considered to be limiting.

Usable Fuel is the fuel available for flight planning.

Unusable Fuel is the quantity of fuel that can not be safely used in flight.

GPH **Gallons Per Hour** is the amount of fuel consumed per hour.

NMPG **Nautical Miles Per Gallon** is the distance which can be expected per gallon of fuel consumed at a specific engine power setting and/or flight configuration.

g is acceleration due to gravity.

WEIGHT AND BALANCE TERMINOLOGY

Reference Datum	Reference Datum is an imaginary vertical plane from which all horizontal distances are measured for balance purposes.
Station	Station is a location along the airplane fuselage given in terms of the distance from the reference datum.
Arm	Arm is the horizontal distance from the reference datum to the center of gravity (C.G.) of an item.
Moment	Moment is the product of the weight of an item multiplied by its arm. (Moment divided by the constant 1000 is used in this handbook to simplify balance calculations by reducing the number of digits.)
Center of Gravity (C.G.)	Center of Gravity is the point at which an airplane, or equipment, would balance if suspended. Its distance from the reference datum is found by dividing the total moment by the total weight of the airplane.
C.G. Arm	Center of Gravity Arm is the arm obtained by adding the airplane's individual moments and dividing the sum by the total weight.
C.G. Limits	Center of Gravity Limits are the extreme center of gravity locations within which the airplane must be operated at a given weight.
Standard Empty Weight	Standard Empty Weight is the weight of a standard airplane, including unusable fuel, full operating fluids and full engine oil.
Basic Empty Weight	Basic Empty Weight is the standard empty weight plus the weight of optional equipment.
Useful Load	Useful Load is the difference between ramp weight and the basic empty weight.
Maximum Ramp Weight	Maximum Ramp Weight is the maximum weight approved for ground maneuver. (It includes the weight of start, taxi, and runup fuel.)
Maximum Takeoff Weight	Maximum Takeoff Weight is the maximum weight approved for the start of the takeoff roll.

CESSNA
MODEL 172P

SECTION 1
GENERAL

Maximum
Landing
Weight

Maximum Landing Weight is the maximum weight approved for the landing touchdown.

Tare

Tare is the weight of chocks, blocks, stands, etc. used when weighing an airplane, and is included in the scale readings. Tare is deducted from the scale reading to obtain the actual (net) airplane weight.

12 May 1981

1-9/(1-10 blank)

Notes: _____

SECTION 2 LIMITATIONS

TABLE OF CONTENTS

	Page
Introduction	2-3
Airspeed Limitations	2-4
Airspeed Indicator Markings	2-5
Power Plant Limitations	2-6
Power Plant Instrument Markings	2-6
Weight Limits	2-6
Normal Category	2-7
Utility Category	2-7
Center Of Gravity Limits	2-7
Normal Category	2-7
Utility Category	2-7
Maneuver Limits	2-7
Normal Category	2-7
Utility Category	2-8
Flight Load Factor Limits	2-8
Normal Category	2-8
Utility Category	2-9
Kinds Of Operation Limits	2-9
Fuel Limitations	2-10
Other Limitations	2-10
Flap Limitations	2-10
Placards	

Notes: _____

INTRODUCTION

Section 2 includes operating limitations, instrument markings, and basic placards necessary for the safe operation of the airplane, its engine, standard systems and standard equipment. The limitations included in this section and in Section 9 have been approved by the Federal Aviation Administration. Observance of these operating limitations is required by Federal Aviation Regulations.

NOTE

Refer to Section 9 of this Pilot's Operating Handbook for amended operating limitations, operating procedures, performance data and other necessary information for airplanes equipped with specific options.

NOTE

The airspeeds listed in the Airspeed Limitations chart (figure 2-1) and the Airspeed Indicator Markings chart (figure 2-2) are based on Airspeed Calibration data shown in Section 5 with the normal static source. If the alternate static source is being used, ample margins should be observed to allow for the airspeed calibration variations between the normal and alternate static sources as shown in Section 5.

Your Cessna is certificated under FAA Type Certificate No. 3A12 as Cessna Model No. 172P.

AIRSPEED LIMITATIONS

Airspeed limitations and their operational significance are shown in figure 2-1. Maneuvering speeds shown apply to normal category operations. The utility category maneuvering speed is 102 KIAS at 2100 pounds.

	SPEED	KCAS	KIAS	REMARKS
V _{NE}	Never Exceed Speed	152	158	Do not exceed this speed in any operation.
V _{NO}	Maximum Structural Cruising Speed	123	127	Do not exceed this speed except in smooth air, and then only with caution.
V _A	Maneuvering Speed: 2400 Pounds 2000 Pounds 1600 Pounds	97 91 81	99 92 82	Do not make full or abrupt control movements above this speed.
V _{FE}	Maximum Flap Extended Speed: 10° Flaps 10° - 30° Flaps	108 84	110 85	Do not exceed this speed with flaps down.
	Maximum Window Open Speed	152	158	Do not exceed this speed with windows open.

Figure 2-1. Airspeed Limitations

AIRSPEED INDICATOR MARKINGS

Airspeed indicator markings and their color code significance are shown in figure 2-2.

MARKING	KIAS VALUE OR RANGE	SIGNIFICANCE
White Arc	33 - 85	Full Flap Operating Range. Lower limit is maximum weight V_{SO} in landing configuration. Upper limit is maximum speed permissible with flaps extended.
Green Arc	44 - 127	Normal Operating Range. Lower limit is maximum weight V_S at most forward C.G. with flaps retracted. Upper limit is maximum structural cruising speed.
Yellow Arc	127 - 158	Operations must be conducted with caution and only in smooth air.
Red Line	158	Maximum speed for all operations.

Figure 2-2. Airspeed Indicator Markings

POWERPLANT LIMITATIONS

Engine Manufacturer: Avco Lycoming.

Engine Model Number: O-320-D2J.

Maximum Power: 160 BHP rating.

Engine Operating Limits for Takeoff and Continuous Operations:

Maximum Engine Speed: 2700 RPM.

NOTE

The static RPM range at full throttle (carburetor heat off and mixture leaned to maximum RPM) is 2300 to 2420 RPM.

Maximum Oil Temperature: 245°F (118°C).

Oil Pressure, Minimum: *25 psi.

Maximum: 115 psi.

Fuel Grade: See Fuel Limitations.

Oil Grade (Specification):

MIL-L-6082 Aviation Grade Straight Mineral Oil or MIL-L-22851

Ashless Dispersant Oil.

Propeller Manufacturer: McCauley Accessory Division.

Propeller Model Number: 1C160/DTM7557.

Propeller Diameter, Maximum: 75 inches.

Minimum: 74 inches.

* 20 psi on airplanes modified by Service Kit SK172-81, SK172-82 or SK172-123A.

POWERPLANT INSTRUMENT MARKINGS

Powerplant instrument markings and their color code significance are shown in Figure 2-3.

INSTRUMENT	RED LINE	GREEN ARC	RED LINE
	MINIMUM LIMIT	NORMAL OPERATING	MAXIMUM LIMIT
Tachometer: Sea Level 5000 Feet 10000 Feet	---	2100 - 2450 RPM 2100 - 2575 RPM 2100 - 2700 RPM	2700 RPM
Oil Temperature	---	100° - 245°F	245°F
Oil Pressure	* 25 psi	* 60 - 90 psi	115 psi
Fuel Quantity (Standard Tanks)	E (1.5 Gal. Unusable Each Tank)	---	---
Fuel Quantity (Long Range Tanks)	E (2.0 Gal. Unusable Each Tank)	---	---
Fuel Quantity (Integral Tanks)	E (3.0 Gal. Unusable Each Tank)	---	---
Suction	---	4.5 - 5.4 in. Hg	---

Figure 2-3. Powerplant Instrument Markings

WEIGHT LIMITS

NORMAL CATEGORY

Maximum Ramp Weight: 2407 lbs.

Maximum Takeoff Weight: 2400 lbs.

Maximum Landing Weight: 2400 lbs.

Maximum Weight in Baggage Compartment:

Baggage Area 1 (or passenger on child's seat) - Station 82 to 108: 120 lbs.

See following note.

Baggage Area 2 - Station 108 to 142: 50 lbs. See following note.

* 20 psi (red line) and 50-90 psi (green arc) on airplanes modified by Service Kit SK172-81, SK172-82 or SK172-123A.

NOTE

The maximum combined weight capacity for baggage areas 1 and 2 is 120 lbs.

UTILITY CATEGORY

Maximum Ramp Weight: 2107 lbs.
Maximum Takeoff Weight: 2100 lbs.
Maximum Landing Weight: 2100 lbs.
Maximum Weight in Baggage Compartment: In the utility category, the baggage compartment and rear seat must not be occupied.

CENTER OF GRAVITY LIMITS

NORMAL CATEGORY

Center of Gravity Range:
Forward: 35.0 inches aft of datum at 1950 lbs. or less, with straight line variation to 39.5 inches aft of datum at 2400 lbs.
Aft: 47.3 inches aft of datum at all weights.
Reference Datum: Lower portion of front face of firewall.

UTILITY CATEGORY

Center of Gravity Range:
Forward: 35.0 inches aft of datum at 1950 lbs. or less, with straight line variation to 36.5 inches aft of datum at 2100 lbs.
Aft: 40.5 inches aft of datum at all weights.
Reference Datum: Lower portion of front face of firewall.

MANEUVER LIMITS

NORMAL CATEGORY

This airplane is certificated in both the normal and utility category. The normal category is applicable to aircraft intended for non-aerobatic operations. These include any maneuvers incidental to normal flying, stalls (except whip stalls), lazy eights, chandelles, and turns in which the angle of bank is not more than 60°. Aerobatic maneuvers, including spins, are not approved.

UTILITY CATEGORY

This airplane is not designed for purely aerobatic flight. However, in the acquisition of various certificates such as commercial pilot and flight

**SECTION 2
LIMITATIONS**

**CESSNA
MODEL 172P**

instructor, certain maneuvers are required by the FAA. All of these maneuvers are permitted in this airplane when operated in the utility category.

In the utility category, the baggage compartment and rear seat must not be occupied. No aerobatic maneuvers are approved except those listed below:

MANEUVER	RECOMMENDED ENTRY SPEED*
Chandelles	105 knots
Lazy Eights	105 knots
Steep Turns	95 knots
Spins	Slow Deceleration
Stalls (Except Whip Stalls)	Slow Deceleration

*Abrupt use of the controls is prohibited above 99 knots.

Aerobatics that may impose high loads should not be attempted. The important thing to bear in mind in flight maneuvers is that the airplane is clean in aerodynamic design and will build up speed quickly with the nose down. Proper speed control is an essential requirement for execution of any maneuver, and care should always be exercised to avoid excessive speed which in turn can impose excessive loads. In the execution of all maneuvers, avoid abrupt use of controls. Intentional spins with flaps extended are prohibited.

FLIGHT LOAD FACTOR LIMITS

NORMAL CATEGORY

Flight Load Factors (Maximum Takeoff Weight - 2400 lbs.):

- *Flaps Up +3.8g, -1.52g
- *Flaps Down +3.0g

*The design load factors are 150% of the above, and in all cases, the structure meets or exceeds design loads.

UTILITY CATEGORY

Flight Load Factors (Maximum Takeoff Weight - 2100 lbs.):

- *Flaps Up +4.4g, -1.76g
- *Flaps Down +3.0g

*The design load factors are 150% of the above, and in all cases, the structure meets or exceeds design loads.

KINDS OF OPERATION LIMITS

The airplane is equipped for day VFR and may be equipped for night VFR and/or IFR operations. FAR Part 91 establishes the minimum required instrumentation and equipment for these operations. The reference to types of flight operations on the operating limitations placard reflects equipment installed at the time of Airworthiness Certificate issuance.

Flight into known icing conditions is prohibited.

FUEL LIMITATIONS

- 2 Standard Tanks: 21.5 U.S. gallons each.
 - Total Fuel: 43 U.S. gallons.
 - Usable Fuel (all flight conditions): 40 U.S. gallons.
 - Unusable Fuel: 3 U.S. gallons.
- 2 Long Range Tanks: 27 U.S. gallons each.
 - Total Fuel: 54 U.S. gallons.
 - Usable Fuel (all flight conditions): 50 U.S. gallons.
 - Unusable Fuel: 4 U.S. gallons.
- 2 Integral Tanks: 34 U.S. gallons each.
 - Total Fuel: 68 U.S. gallons.
 - Usable Fuel (all flight conditions): 62 U.S. gallons.
 - Unusable Fuel: 6 U.S. gallons.

NOTE

To ensure maximum fuel capacity when refueling and minimize cross-feeding when parked on a sloping surface, place the fuel selector valve in either LEFT or RIGHT position.

Takeoff and land with the fuel selector valve handle in the BOTH position.

Maximum slip or skid duration with one tank dry: 30 seconds.

With 1/4 tank or less, prolonged uncoordinated flight is prohibited when operating on either left or right tank in level flight.

Fuel remaining in the tank after the fuel quantity indicator reads empty (red line) cannot be safely used in flight.

Approved Fuel Grades (and Colors):

- 100LL Grade Aviation Fuel (Blue).
- 100 (Formerly 100/130) Grade Aviation Fuel (Green).

OTHER LIMITATIONS

FLAP LIMITATIONS

Approved Takeoff Range: 0° to 10°.
Approved Landing Range: 0° to 30°.

PLACARDS

The following information must be displayed in the form of composite or individual placards.

1. In full view of the pilot: (The "DAY-NIGHT-VFR-IFR" entry, shown on the example below, will vary as the airplane is equipped.)

The markings and placards installed in this airplane contain operating limitations which must be complied with when operating this airplane in the Normal Category. Other operating limitations which must be complied with when operating this airplane in this category or in the Utility Category are contained in the Pilot's Operating Handbook and FAA Approved Airplane Flight Manual.

Normal Category - No acrobatic maneuvers, including spins, approved.

Utility Category - No acrobatic maneuvers approved, except those listed in the Pilot's Operating Handbook.

Baggage compartment and rear seat must not be occupied.

Spin Recovery - Opposite rudder - forward elevator - neutralize controls.

Flight into known icing conditions prohibited.

This airplane is certified for the following flight operations as of date of original airworthiness certificate:

DAY-NIGHT-VFR-IFR

2. On the fuel selector valve (standard tanks):

TAKEOFF LANDING	BOTH 40.0 GAL.	ALL FLIGHT ATTITUDES
LEFT 20.0 GAL. LEVEL FLIGHT ONLY		RIGHT 20.0 GAL. LEVEL FLIGHT ONLY
		FUEL SELECTOR
	OFF	OFF

On the fuel selector valve (long range tanks):

TAKEOFF LANDING	BOTH 50.0 GAL.	ALL FLIGHT ATTITUDES
LEFT 25.0 GAL. LEVEL FLIGHT ONLY		RIGHT 25.0 GAL. LEVEL FLIGHT ONLY
		FUEL SELECTOR
	OFF	OFF

On the fuel selector valve (integral tanks):

TAKEOFF LANDING	BOTH 62.0 GAL.	ALL FLIGHT ATTITUDES
LEFT 31.0 GAL. LEVEL FLIGHT ONLY		RIGHT 31.0 GAL. LEVEL FLIGHT ONLY
		FUEL SELECTOR
	OFF	OFF

3. Near fuel tank filler cap (standard tanks):

FUEL
100LL/100 MIN. GRADE AVIATION GASOLINE
CAP. 21.5 U.S. GAL.

Near fuel tank filler cap (long range tanks):

FUEL
100LL/100 MIN. GRADE AVIATION GASOLINE
CAP. 27 U.S. GAL.

Near fuel tank filler cap (integral tanks):

FUEL
100LL/100 MIN. GRADE AVIATION GASOLINE
CAP. 34 U.S. GAL.
CAP. 24.0 U.S. GAL. TO BOTTOM OF FILLER COLLAR

4. Near wing flap switch:

AVOID SLIPS WITH FLAPS EXTENDED

5. On flap control indicator:

0° to 10°	(Partial flap range with blue color code and 110 kt callout; also, mechanical detent at 10°.)
10° to 30°	(Indices at these positions with white color code and 85 kt callout; also, mechanical detent at 10° and 20°.)

6. In baggage compartment:

120 POUNDS MAXIMUM
BAGGAGE AND/OR AUXILIARY PASSENGER
FORWARD OF BAGGAGE DOOR LATCH

50 POUNDS MAXIMUM
BAGGAGE AFT OF BAGGAGE DOOR LATCH

MAXIMUM 120 POUNDS COMBINED

FOR ADDITIONAL LOADING INSTRUCTIONS
SEE WEIGHT AND BALANCE DATA

7. A calibration card must be provided to indicate the accuracy of the magnetic compass in 30° increments.

8. On oil filler cap:

OIL
7 QTS

9. On control lock:

CAUTION!
CONTROL LOCK
REMOVE BEFORE STARTING ENGINE

10. Near airspeed indicator:

MANEUVER SPEED - 99 KIAS

Notes: _____

SECTION 3

EMERGENCY PROCEDURES

TABLE OF CONTENTS

	Page
Introduction	3-3
Airspeeds For Emergency Operation	3-3

OPERATIONAL CHECKLISTS

Engine Failures	3-3
Engine Failure During Takeoff Roll	3-3
Engine Failure Immediately After Takeoff	3-4
Engine Failure During Flight (Restart Procedures)	3-4
Forced Landings	3-4
Emergency Landing Without Engine Power	3-4
Precautionary Landing With Engine Power	3-4
Ditching	3-5
Fires	3-5
During Start On Ground	3-5
Engine Fire In Flight	3-6
Electrical Fire In Flight	3-6
Cabin Fire	3-7
Wing Fire	3-7
Icing	3-7
Inadvertent Icing Encounter	3-7
Static Source Blockage (Erroneous Instrument Reading Suspected)	3-8
Landing With A Flat Main Tire	3-8
Electrical Power Supply System Malfunctions	3-9
Ammeter Shows Excessive Rate of Charge (Full Scale Deflection)	3-9
Low-Voltage Light Illuminates During Flight (Ammeter Indicates Discharge)	3-9

AMPLIFIED PROCEDURES

Engine Failure	3-11
Forced Landings	3-12
Landing Without Elevator Control	3-12
Fires	3-12

TABLE OF CONTENTS (Continued)

	Page
Emergency Operation In Clouds (Vacuum System Failure)	3-13
Executing A 180° Turn In Clouds	3-13
Emergency Descent Through Clouds	3-13
Recovery From A Spiral Dive	3-14
Inadvertent Flight Into Icing Conditions	3-14
Static Source Blocked	3-14
Spins	3-15
Rough Engine Operation Or Loss Of Power	3-16
Carburetor Icing	3-16
Spark Plug Fouling	3-16
Magneto Malfunction	3-16
Low Oil Pressure	3-16
Electrical Power Supply System Malfunctions	3-17
Excessive Rate Of Charge	3-17
Insufficient Rate Of Charge	3-17

INTRODUCTION

Section 3 provides checklist and amplified procedures for coping with emergencies that may occur. Emergencies caused by airplane or engine malfunctions are extremely rare if proper preflight inspections and maintenance are practiced. Enroute weather emergencies can be minimized or eliminated by careful flight planning and good judgment when unexpected weather is encountered. However, should an emergency arise, the basic guidelines described in this section should be considered and applied as necessary to correct the problem. Emergency procedures associated with ELT and other optional systems can be found in Section 9.

AIRSPEEDS FOR EMERGENCY OPERATION

Engine Failure After Takeoff:	65 KIAS
Wing Flaps Up	60 KIAS
Wing Flaps Down	
Maneuvering Speed:	99 KIAS
2400 Lbs	92 KIAS
2000 Lbs	82 KIAS
1600 Lbs	65 KIAS
Maximum Glide	60 KIAS
Precautionary Landing With Engine Power	
Landing Without Engine Power:	65 KIAS
Wing Flaps Up	60 KIAS
Wing Flaps Down	

OPERATIONAL CHECKLISTS

Procedures in the Operational Checklists portion of this section shown in **bold-faced** type are immediate-action items which should be committed to memory.

ENGINE FAILURES

ENGINE FAILURE DURING TAKEOFF ROLL

1. **Throttle -- IDLE.**
2. **Brakes -- APPLY.**

3. Wing Flaps -- RETRACT.
4. Mixture -- IDLE CUT-OFF.
5. Ignition Switch -- OFF.
6. Master Switch -- OFF.

ENGINE FAILURE IMMEDIATELY AFTER TAKEOFF

1. Airspeed -- 65 KIAS (flaps UP).
60 KIAS (flaps DOWN).
2. Mixture -- IDLE CUT-OFF.
3. Fuel Selector Valve -- OFF.
4. Ignition Switch -- OFF.
5. Wing Flaps -- AS REQUIRED.
6. Master Switch -- OFF.

ENGINE FAILURE DURING FLIGHT (RESTART PROCEDURES)

1. Airspeed -- 65 KIAS.
2. Carburetor Heat -- ON.
3. Fuel Selector Valve -- BOTH.
4. Mixture -- RICH.
5. Ignition Switch -- BOTH (or START if propeller is stopped).
6. Primer -- IN and LOCKED.

FORCED LANDINGS

EMERGENCY LANDING WITHOUT ENGINE POWER

1. Airspeed -- 65 KIAS (flaps UP).
60 KIAS (flaps DOWN).
2. Mixture -- IDLE CUT-OFF.
3. Fuel Selector Valve -- OFF.
4. Ignition Switch -- OFF.
5. Wing Flaps -- AS REQUIRED (30° recommended).
6. Master Switch -- OFF.
7. Doors -- UNLATCH PRIOR TO TOUCHDOWN.
8. Touchdown -- SLIGHTLY TAIL LOW.
9. Brakes -- APPLY HEAVILY.

PRECAUTIONARY LANDING WITH ENGINE POWER

1. Wing Flaps -- 20°.
2. Airspeed -- 60 KIAS.
3. Selected Field -- FLY OVER, noting terrain and obstructions, then retract flaps upon reaching a safe altitude and airspeed.

4. Avionics Power Switch and Electrical Switches -- OFF.
5. Wing Flaps -- 30° (on final approach).
6. Airspeed -- 60 KIAS.
7. Master Switch -- OFF.
8. Doors -- UNLATCH PRIOR TO TOUCHDOWN.
9. Touchdown -- SLIGHTLY TAIL LOW.
10. Ignition Switch -- OFF.
11. Brakes -- APPLY HEAVILY.

DITCHING

1. Radio -- TRANSMIT MAYDAY on 121.5 MHz, giving location and intentions and SQUAWK 7700 if transponder is installed.
2. Heavy Objects (in baggage area) -- SECURE OR JETTISON.
3. Approach -- High Winds, Heavy Seas -- INTO THE WIND.
Light Winds, Heavy Swells -- PARALLEL TO SWELLS.
4. Wing Flaps -- 20° - 30°.
5. Power -- ESTABLISH 300 FT/MIN DESCENT AT 55 KIAS.

NOTE

If no power is available, approach at 65 KIAS with flaps up or at 60 KIAS with 10° flaps.

6. Cabin Doors -- UNLATCH.
7. Touchdown -- LEVEL ATTITUDE AT ESTABLISHED RATE OF DESCENT.
8. Face -- CUSHION at touchdown with folded coat.
9. Airplane -- EVACUATE through cabin doors. If necessary, open window and flood cabin to equalize pressure so doors can be opened.
10. Life Vests and Raft -- INFLATE.

FIRES

DURING START ON GROUND

1. Cranking -- CONTINUE, to get a start which would suck the flames and accumulated fuel through the carburetor and into the engine.

If engine starts:

2. Power -- 1700 RPM for a few minutes.
3. Engine -- SHUTDOWN and inspect for damage.

If engine fails to start:

4. **Throttle -- FULL OPEN.**
5. **Mixture -- IDLE CUT-OFF.**
6. **Cranking -- CONTINUE.**
7. **Fire Extinguisher -- OBTAIN** (have ground attendants obtain if not installed).
8. **Engine -- SECURE.**
 - a. **Master Switch -- OFF.**
 - b. **Ignition Switch -- OFF.**
 - c. **Fuel Selector Valve -- OFF.**
9. **Fire -- EXTINGUISH** using fire extinguisher, wool blanket, or dirt.
10. **Fire Damage -- INSPECT**, repair damage or replace damaged components or wiring before conducting another flight.

ENGINE FIRE IN FLIGHT

1. **Mixture -- IDLE CUT-OFF.**
2. **Fuel Selector Valve -- OFF.**
3. **Master Switch -- OFF.**
4. **Cabin Heat and Air -- OFF** (except overhead vents).
5. **Airspeed -- 100 KIAS** (If fire is not extinguished, increase glide speed to find an airspeed which will provide an incombustible mixture).
6. **Forced Landing -- EXECUTE** (as described in Emergency Landing Without Engine Power).

ELECTRICAL FIRE IN FLIGHT

1. **Master Switch -- OFF.**
2. **Avionics Power Switch -- OFF.**
3. **All Other Switches (except ignition switch) -- OFF.**
4. **Vents/Cabin Air/Heat -- CLOSED.**
5. **Fire Extinguisher -- ACTIVATE** (if available).

WARNING

After discharging an extinguisher within a closed cabin, ventilate the cabin.

If fire appears out and electrical power is necessary for continuance of flight:

6. **Master Switch -- ON.**
7. **Circuit Breakers -- CHECK** for faulty circuit, do not reset.

8. Radio Switches -- OFF.
9. Avionics Power Switch -- ON.
10. Radio/Electrical Switches -- ON one at a time, with delay after each until short circuit is localized.
11. Vents/Cabin Air/Heat -- OPEN when it is ascertained that fire is completely extinguished.

CABIN FIRE

1. Master Switch -- OFF.
2. Vents/Cabin Air/Heat -- CLOSED (to avoid drafts).
3. Fire Extinguisher -- ACTIVATE (if available).

WARNING

After discharging an extinguisher within a closed cabin, ventilate the cabin.

4. Land the airplane as soon as possible to inspect for damage.

WING FIRE

1. Landing/Taxi Light Switches -- OFF.
2. Pitot Heat Switch (if installed) -- OFF.
3. Navigation Light Switch -- OFF.
4. Strobe Light Switch (if installed) -- OFF.

NOTE

Perform a sideslip to keep the flames away from the fuel tank and cabin, and land as soon as possible using flaps only as required for final approach and touchdown.

ICING

INADVERTENT ICING ENCOUNTER

1. Turn pitot heat switch ON (if installed).
2. Turn back or change altitude to obtain an outside air temperature that is less conducive to icing.
3. Pull cabin heat control full out and open defroster outlets to obtain maximum windshield defroster airflow. Adjust cabin air control to get maximum defroster heat and airflow.

4. Open the throttle to increase engine speed and minimize ice build-up on propeller blades.
5. Watch for signs of carburetor air filter ice and apply carburetor heat as required. An unexplained loss in engine speed could be caused by carburetor ice or air intake filter ice. Lean the mixture for maximum RPM, if carburetor heat is used continuously.
6. Plan a landing at the nearest airport. With an extremely rapid ice build-up, select a suitable "off airport" landing site.
7. With an ice accumulation of 1/4 inch or more on the wing leading edges, be prepared for significantly higher stall speed.
8. Leave wing flaps retracted. With a severe ice build-up on the horizontal tail, the change in wing wake airflow direction caused by wing flap extension could result in a loss of elevator effectiveness.
9. Open left window and, if practical, scrape ice from a portion of the windshield for visibility in the landing approach.
10. Perform a landing approach using a forward slip, if necessary, for improved visibility.
11. Approach at 65 to 75 KIAS depending upon the amount of the accumulation.
12. Perform a landing in level attitude.

**STATIC SOURCE BLOCKAGE
(Erroneous Instrument Reading Suspected)**

1. **Static Pressure Alternate Source Valve (if installed) -- PULL ON.**

NOTE

In an emergency on airplanes not equipped with an alternate static source, cabin pressure can be supplied to the static pressure instruments by breaking the glass in the face of the vertical speed indicator.

2. **Airspeed -- Consult appropriate calibration tables in Section 5.**

LANDING WITH A FLAT MAIN TIRE

1. **Approach -- NORMAL.**
2. **Touchdown -- GOOD TIRE FIRST, hold airplane off flat tire as long as possible.**

ELECTRICAL POWER SUPPLY SYSTEM MALFUNCTIONS

AMMETER SHOWS EXCESSIVE RATE OF CHARGE (Full Scale Deflection)

1. Alternator -- OFF.
2. Alternator Circuit Breaker -- PULL.
3. Nonessential Electrical Equipment -- OFF.
4. Flight -- TERMINATE as soon as practical.

LOW-VOLTAGE LIGHT ILLUMINATES DURING FLIGHT (Ammeter Indicates Discharge)

NOTE

Illumination of the low-voltage light may occur during low RPM conditions with an electrical load on the system such as during a low RPM taxi. Under these conditions, the light will go out at higher RPM. The master switch need not be recycled since an over-voltage condition has not occurred to de-activate the alternator system.

1. Avionics Power Switch -- OFF.
2. Alternator Circuit Breaker -- CHECK IN.
3. Master Switch -- OFF (both sides).
4. Master Switch -- ON.
5. Low-Voltage Light -- CHECK OFF.
6. Avionics Power Switch -- ON.

If low-voltage light illuminates again:

7. Alternator -- OFF.
8. Nonessential Radio and Electrical Equipment -- OFF.
9. Flight -- TERMINATE as soon as practical.

Notes: _____

AMPLIFIED PROCEDURES

The following Amplified Procedures elaborate upon information contained in the Operational Checklists portion of this section. These procedures also include information not readily adaptable to a checklist format, and material to which a pilot could not be expected to refer in resolution of a specific emergency.

ENGINE FAILURE

If an engine failure occurs during the takeoff roll, the most important thing to do is stop the airplane on the remaining runway. Those extra items on the checklist will provide added safety after a failure of this type.

Prompt lowering of the nose to maintain airspeed and establish a glide attitude is the first response to an engine failure after takeoff. In most cases, the landing should be planned straight ahead with only small changes in direction to avoid obstructions. Altitude and airspeed are seldom sufficient to execute a 180° gliding turn necessary to return to the runway. The checklist procedures assume that adequate time exists to secure the fuel and ignition systems prior to touchdown.

After an engine failure in flight, the best glide speed as shown in figure 3-1 should be established as quickly as possible. While gliding toward a

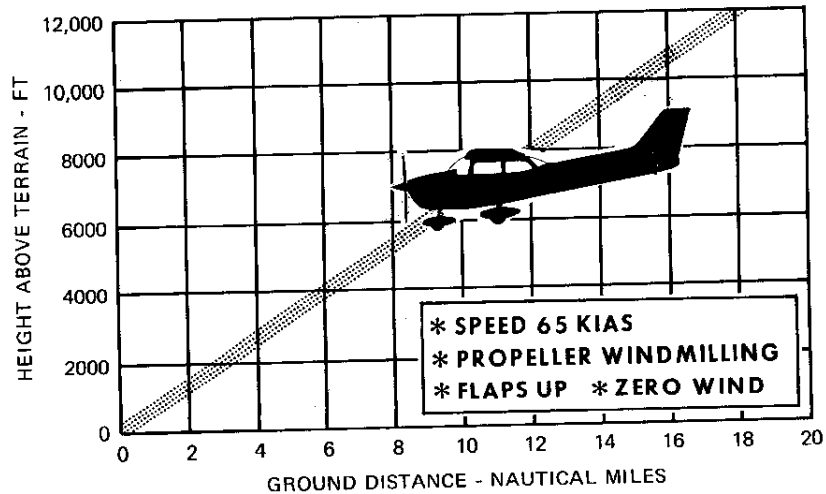

Figure 3-1. Maximum Glide

suitable landing area, an effort should be made to identify the cause of the failure. If time permits, an engine restart should be attempted as shown in the checklist. If the engine cannot be restarted, a forced landing without power must be completed.

FORCED LANDINGS

If all attempts to restart the engine fail and a forced landing is imminent, select a suitable field and prepare for the landing as discussed under the Emergency Landing Without Engine Power checklist.

Before attempting an "off airport" landing with engine power available, one should fly over the landing area at a safe but low altitude to inspect the terrain for obstructions and surface conditions, proceeding as discussed under the Precautionary Landing With Engine Power checklist.

Prepare for ditching by securing or jettisoning heavy objects located in the baggage area and collect folded coats for protection of occupants' face at touchdown. Transmit Mayday message on 121.5 MHz giving location and intentions and squawk 7700 if a transponder is installed. Avoid a landing flare because of difficulty in judging height over a water surface.

LANDING WITHOUT ELEVATOR CONTROL

Trim for horizontal flight (with an airspeed of approximately 65 KIAS and flaps set to 20°) by using throttle and elevator trim controls. Then **do not change the elevator trim control setting**; control the glide angle by adjusting power exclusively.

At flareout, the nose-down moment resulting from power reduction is an adverse factor and the airplane may hit on the nose wheel. Consequently, at flareout, the elevator trim control should be adjusted toward the full nose-up position and the power adjusted so that the airplane will rotate to the horizontal attitude for touchdown. Close the throttle at touchdown.

FIRES

Although engine fires are extremely rare in flight, the steps of the appropriate checklist should be followed if one is encountered. After completion of this procedure, execute a forced landing. Do not attempt to restart the engine.

The initial indication of an electrical fire is usually the odor of burning insulation. The checklist for this problem should result in elimination of the fire.

EMERGENCY OPERATION IN CLOUDS (Vacuum System Failure)

In the event of a vacuum system failure during flight, the directional indicator and attitude indicator will be disabled, and the pilot will have to rely on the turn coordinator if he inadvertently flies into clouds. The following instructions assume that only the electrically-powered turn coordinator is operative, and that the pilot is not completely proficient in instrument flying.

EXECUTING A 180° TURN IN CLOUDS

Upon inadvertently entering the clouds, an immediate plan should be made to turn back as follows:

1. Note the compass heading.
2. Note the time of the minute hand and observe the position of the sweep second hand on the clock.
3. When the sweep second hand indicates the nearest half-minute, initiate a standard rate left turn, holding the turn coordinator symbolic airplane wing opposite the lower left index mark for 60 seconds. Then roll back to level flight by leveling the miniature airplane.
4. Check accuracy of the turn by observing the compass heading which should be the reciprocal of the original heading.
5. If necessary, adjust heading primarily with skidding motions rather than rolling motions so that the compass will read more accurately.
6. Maintain altitude and airspeed by cautious application of elevator control. Avoid overcontrolling by keeping the hands off the control wheel as much as possible and steering only with rudder.

EMERGENCY DESCENT THROUGH CLOUDS

If conditions preclude reestablishment of VFR flight by a 180° turn, a descent through a cloud deck to VFR conditions may be appropriate. If possible, obtain radio clearance for an emergency descent through clouds. To guard against a spiral dive, choose an easterly or westerly heading to minimize compass card swings due to changing bank angles. In addition, keep hands off the control wheel and steer a straight course with rudder control by monitoring the turn coordinator. Occasionally check the compass heading and make minor corrections to hold an approximate course. Before descending into the clouds, set up a stabilized let-down condition as follows:

1. Apply full rich mixture.
2. Use full carburetor heat.
3. Reduce power to set up a 500 to 800 ft/min rate of descent.
4. Adjust the elevator trim and rudder trim (if installed) for a stabilized descent at 70-80 KIAS.
5. Keep hands off the control wheel.
6. Monitor turn coordinator and make corrections by rudder alone.
7. Check trend of compass card movement and make cautious corrections with rudder to stop the turn.
8. Upon breaking out of clouds, resume normal cruising flight.

RECOVERY FROM A SPIRAL DIVE

If a spiral is encountered, proceed as follows:

1. Close the throttle.
2. Stop the turn by using coordinated aileron and rudder control to align the symbolic airplane in the turn coordinator with the horizon reference line.
3. Cautiously apply elevator back pressure to slowly reduce the airspeed to 80 KIAS.
4. Adjust the elevator trim control to maintain an 80 KIAS glide.
5. Keep hands off the control wheel, using rudder control to hold a straight heading. Adjust rudder trim (if installed) to relieve unbalanced rudder force.
6. Apply carburetor heat.
7. Clear engine occasionally, but avoid using enough power to disturb the trimmed glide.
8. Upon breaking out of clouds, resume normal cruising flight.

INADVERTENT FLIGHT INTO ICING CONDITIONS

Flight into icing conditions is prohibited. An inadvertent encounter with these conditions can best be handled using the checklist procedures. The best procedure, of course, is to turn back or change altitude to escape icing conditions.

STATIC SOURCE BLOCKED

If erroneous readings of the static source instruments (airspeed, altimeter and vertical speed) are suspected, the static pressure alternate source valve should be pulled on, thereby supplying static pressure to these instruments from the cabin.

NOTE

In an emergency on airplanes not equipped with an alternate static source, cabin pressure can be supplied to the static pressure instruments by breaking the glass in the face of the vertical speed indicator.

With the alternate static source on, adjust indicated airspeed slightly during climb or approach according to the alternate static source airspeed calibration table in Section 5, appropriate to vent/window(s) configuration, causing the airplane to be flown at the normal operating speeds.

Maximum airspeed and altimeter variation from normal is 4 knots and 30 feet over the normal operating range with the window(s) closed. With window(s) open, larger variations occur near stall speed. However, maximum altimeter variation remains within 50 feet of normal.

SPINS

Should an inadvertent spin occur, the following recovery procedure should be used:

1. RETARD THROTTLE TO IDLE POSITION.
2. PLACE AILERONS IN NEUTRAL POSITION.
3. APPLY AND **HOLD** FULL RUDDER OPPOSITE TO THE DIRECTION OF ROTATION.
4. **JUST AFTER** THE RUDDER REACHES THE STOP, MOVE THE CONTROL WHEEL **BRISKLY** FORWARD FAR ENOUGH TO BREAK THE STALL. Full down elevator may be required at aft center of gravity loadings to assure optimum recoveries.
5. **HOLD THESE CONTROL INPUTS UNTIL ROTATION STOPS.** Premature relaxation of the control inputs may extend the recovery.
6. **AS ROTATION STOPS, NEUTRALIZE RUDDER, AND MAKE A SMOOTH RECOVERY FROM THE RESULTING DIVE.**

NOTE

If disorientation precludes a visual determination of the direction of rotation, the symbolic airplane in the turn coordinator may be referred to for this information.

For additional information on spins and spin recovery, see the discussion under SPINS in Normal Procedures (Section 4).

ROUGH ENGINE OPERATION OR LOSS OF POWER

CARBURETOR ICING

A gradual loss of RPM and eventual engine roughness may result from the formation of carburetor ice. To clear the ice, apply full throttle and pull the carburetor heat knob full out until the engine runs smoothly; then remove carburetor heat and readjust the throttle. If conditions require the continued use of carburetor heat in cruise flight, use the minimum amount of heat necessary to prevent ice from forming and lean the mixture for smoothest engine operation.

SPARK PLUG FOULING

A slight engine roughness in flight may be caused by one or more spark plugs becoming fouled by carbon or lead deposits. This may be verified by turning the ignition switch momentarily from BOTH to either L or R position. An obvious power loss in single ignition operation is evidence of spark plug or magneto trouble. Assuming that spark plugs are the more likely cause, lean the mixture to the recommended lean setting for cruising flight. If the problem does not clear up in several minutes, determine if a richer mixture setting will produce smoother operation. If not, proceed to the nearest airport for repairs using the BOTH position of the ignition switch unless extreme roughness dictates the use of a single ignition position.

MAGNETO MALFUNCTION

A sudden engine roughness or misfiring is usually evidence of magneto problems. Switching from BOTH to either L or R ignition switch position will identify which magneto is malfunctioning. Select different power settings and enrichen the mixture to determine if continued operation on BOTH magnetos is practicable. If not, switch to the good magneto and proceed to the nearest airport for repairs.

LOW OIL PRESSURE

If low oil pressure is accompanied by normal oil temperature, there is a possibility the oil pressure gage or relief valve is malfunctioning. A leak in the line to the gage is not necessarily cause for an immediate precautionary landing because an orifice in this line will prevent a sudden loss of oil from the engine sump. However, a landing at the nearest airport would be advisable to inspect the source of trouble.

If a total loss of oil pressure is accompanied by a rise in oil temperature, there is good reason to suspect an engine failure is imminent. Reduce

engine power immediately and select a suitable forced landing field. Use only the minimum power required to reach the desired touchdown spot.

ELECTRICAL POWER SUPPLY SYSTEM MALFUNCTIONS

Malfunctions in the electrical power supply system can be detected by periodic monitoring of the ammeter and low-voltage warning light; however, the cause of these malfunctions is usually difficult to determine. A broken alternator drive belt or wiring is most likely the cause of alternator failures, although other factors could cause the problem. A defective alternator control unit can also cause malfunctions. Problems of this nature constitute an electrical emergency and should be dealt with immediately. Electrical power malfunctions usually fall into two categories: excessive rate of charge and insufficient rate of charge. The following paragraphs describe the recommended remedy for each situation.

EXCESSIVE RATE OF CHARGE

After engine starting and heavy electrical usage at low engine speeds (such as extended taxiing) the battery condition will be low enough to accept above normal charging during the initial part of a flight. However, after thirty minutes of cruising flight, the ammeter should be indicating less than two needle widths of charging current. If the charging rate were to remain above this value on a long flight, the battery would overheat and evaporate the electrolyte at an excessive rate.

Electronic components in the electrical system can be adversely affected by higher than normal voltage. The alternator control unit includes an over-voltage sensor which normally will automatically shut down the alternator if the charge voltage reaches approximately 31.5 volts. If the over-voltage sensor malfunctions, as evidenced by an excessive rate of charge shown on the ammeter, the alternator should be turned off, alternator circuit breaker pulled, nonessential electrical equipment turned off and the flight terminated as soon as practical.

INSUFFICIENT RATE OF CHARGE

NOTE

Illumination of the low-voltage light and ammeter discharge indications may occur during low RPM conditions with an electrical load on the system, such as during a low

SECTION 3
EMERGENCY PROCEDURES

CESSNA
MODEL 172P

RPM taxi. Under these conditions, the light will go out at higher RPM. The master switch need not be recycled since an over-voltage condition has not occurred to de-activate the alternator system.

If the over-voltage sensor should shut down the alternator, or if the alternator output is low, a discharge rate will be shown on the ammeter followed by illumination of the low-voltage warning light. Since this may be a "nuisance" trip-out, an attempt should be made to reactivate the alternator system. To do this, turn the avionics power switch off, check that the alternator circuit breaker is in, then turn both sides of the master switch off and then on again. If the problem no longer exists, normal alternator charging will resume and the low-voltage light will go off. The avionics power switch may then be turned back on. If the light illuminates again, a malfunction is confirmed. In this event, the flight should be terminated and/or the current drain on the battery minimized because the battery can supply the electrical system for only a limited period of time. Battery power must be conserved for later operation of the wing flaps and, if the emergency occurs at night, for possible use of the landing lights during landing.

SECTION 4

NORMAL PROCEDURES

TABLE OF CONTENTS

	Page
Introduction	4-3
Speeds For Normal Operation	4-3
CHECKLIST PROCEDURES	
Preflight Inspection	4-5
Cabin	4-5
Empennage	4-5
Right Wing, Trailing Edge	4-5
Right Wing	4-5
Nose	4-6
Left Wing	4-6
Left Wing, Leading Edge	4-6
Left Wing, Trailing Edge	4-7
Before Starting Engine	4-7
Starting Engine	4-7
Before Takeoff	4-8
Takeoff	4-8
Normal Takeoff	4-8
Short Field Takeoff	4-8
Enroute Climb	4-9
Cruise	4-9
Descent	4-9
Before Landing	4-9
Landing	4-9
Normal Landing	4-9
Short Field Landing	4-10
Balked Landing	4-10
After Landing	4-10
Securing Airplane	4-10
AMPLIFIED PROCEDURES	
Preflight Inspection	4-11
Starting Engine	4-12
12 May 1981	4-1

TABLE OF CONTENTS (Continued)

	Page
Taxiing	4-12
Before Takeoff	4-14
Warm-Up	4-14
Magnetos Check	4-14
Alternator Check	4-14
Takeoff	4-14
Power Check	4-14
Wing Flap Settings	4-15
Crosswind Takeoff	4-16
Enroute Climb	4-16
Cruise	4-16
Leaning With A Cessna Economy Mixture Indicator (EGT)	4-18
Stalls	4-18
Spins	4-18
Landing	4-20
Normal Landing	4-20
Short Field Landing	4-21
Crosswind Landing	4-21
Balked Landing	4-21
Cold Weather Operation	4-22
Starting	4-22
Flight Operations	4-24
Hot Weather Operation	4-24
Noise Characteristics	4-24

INTRODUCTION

Section 4 provides checklist and amplified procedures for the conduct of normal operation. Normal procedures associated with optional systems can be found in Section 9.

SPEEDS FOR NORMAL OPERATION

Unless otherwise noted, the following speeds are based on a maximum weight of 2400 pounds and may be used for any lesser weight. However, to achieve the performance specified in Section 5 for takeoff distance, the speed appropriate to the particular weight must be used.

Takeoff:	
Normal Climb Out	70-80 KIAS
Short Field Takeoff, Flaps 10°, Speed at 50 Feet	56 KIAS
Enroute Climb, Flaps Up:	
Normal, Sea Level	75-85 KIAS
Normal, 10,000 Feet	70-80 KIAS
Best Rate of Climb, Sea Level	76 KIAS
Best Rate of Climb, 10,000 Feet	71 KIAS
Best Angle of Climb, Sea Level	60 KIAS
Best Angle of Climb, 10,000 Feet	65 KIAS
Landing Approach:	
Normal Approach, Flaps Up	65-75 KIAS
Normal Approach, Flaps 30°	60-70 KIAS
Short Field Approach, Flaps 30°	61 KIAS
Balked Landing:	
Maximum Power, Flaps 20°	55 KIAS
Maximum Recommended Turbulent Air Penetration Speed:	
2400 Lbs	99 KIAS
2000 Lbs	92 KIAS
1600 Lbs	82 KIAS
Maximum Demonstrated Crosswind Velocity:	
Takeoff or Landing	15 KNOTS

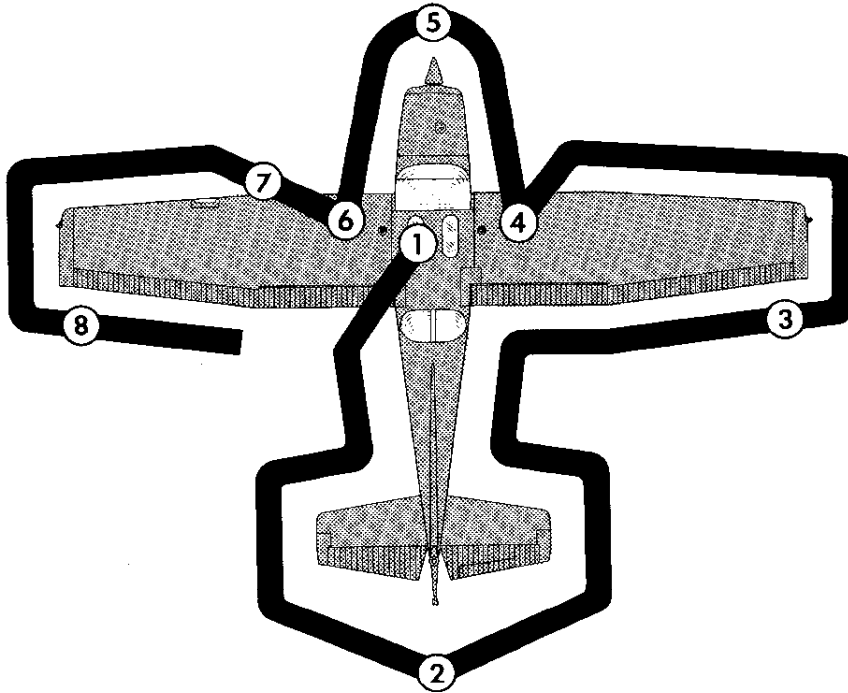

NOTE

Visually check airplane for general condition during walk-around inspection. Use of the refueling steps and assist handles (if installed) will simplify access to the upper wing surfaces for visual checks and refueling operations. In cold weather, remove even small accumulations of frost, ice or snow from wing, tail and control surfaces. Also, make sure that control surfaces contain no internal accumulations of ice or debris. Prior to flight, check that pitot heater (if installed) is warm to touch within 30 seconds with battery and pitot heat switches on. If a night flight is planned, check operation of all lights, and make sure a flashlight is available.

Figure 4-1. Preflight Inspection

CHECKLIST PROCEDURES

PREFLIGHT INSPECTION

① CABIN

1. Pilot's Operating Handbook -- AVAILABLE IN THE AIRPLANE.
2. Parking Brake -- SET.
3. Control Wheel Lock -- REMOVE.
4. Ignition Switch -- OFF.
5. Avionics Power Switch -- OFF.
6. Master Switch -- ON.

WARNING

When turning on the master switch, using an external power source, or pulling the propeller through by hand, treat the propeller as if the ignition switch were on. Do not stand, nor allow anyone else to stand, within the arc of the propeller, since a loose or broken wire or a component malfunction could cause the propeller to rotate.

7. Fuel Quantity Indicators -- CHECK QUANTITY.
8. Avionics Cooling Fan -- CHECK AUDIBLY FOR OPERATION.
9. Master Switch -- OFF.
10. Static Pressure Alternate Source Valve (if installed) -- OFF.
11. Fuel Selector Valve -- BOTH.
12. Baggage Door -- CHECK, lock with key if child's seat is to be occupied.

② EMPENNAGE

1. Rudder Gust Lock -- REMOVE.
2. Tail Tie-Down -- DISCONNECT.
3. Control Surfaces -- CHECK freedom of movement and security.

③ RIGHT WING Trailing Edge

1. Aileron -- CHECK freedom of movement and security.

④ RIGHT WING

1. Wing Tie-Down -- DISCONNECT.
2. Main Wheel Tire -- CHECK for proper inflation.

3. Fuel Tank Sump Quick-Drain Valve -- DRAIN fuel (using sampler cup) to check for water, sediment, and proper fuel grade before first flight of day and after each refueling. If water is observed, take further samples until there is no evidence of water contamination.
4. Fuel Selector Quick-Drain Valve (located on bottom of fuselage) -- DRAIN fuel (using sampler cup) to check for water, sediment, and proper fuel grade before first flight of day and after each refueling. If water is observed, take further samples until there is no evidence of water contamination.
5. Fuel Quantity -- CHECK VISUALLY for desired level.
6. Fuel Filler Cap -- SECURE.

⑤ NOSE

1. Engine Oil Dipstick/Filler Cap -- CHECK oil level, then check dipstick/filler cap SECURE. Do not operate with less than five quarts. Fill to seven quarts for extended flight.
2. Fuel Strainer Drain Knob -- PULL OUT for about four seconds to clear strainer of possible water and sediment before first flight of day and after each refueling. Return drain knob full in and check strainer drain CLOSED. If water is observed, the fuel system may contain additional water, and further draining of the system at the strainer, fuel tank sumps, and fuel selector quick-drain valve must be accomplished.
3. Propeller and Spinner -- CHECK for nicks and security.
4. Carburetor Air Filter -- CHECK for restrictions by dust or other foreign matter.
5. Nose Wheel Strut and Tire -- CHECK for proper inflation.
6. Nose Tie-Down -- DISCONNECT.
7. Static Source Opening (left side of fuselage) -- CHECK for stoppage.

⑥ LEFT WING

1. Main Wheel Tire -- CHECK for proper inflation.
2. Fuel Tank Sump Quick-Drain Valve -- DRAIN fuel (using sampler cup) to check for water, sediment, and proper fuel grade before first flight of day and after each refueling. If water is observed, take further samples until there is no evidence of water contamination.
3. Fuel Quantity -- CHECK VISUALLY for desired level.
4. Fuel Filler Cap -- SECURE.

⑦ LEFT WING Leading Edge

1. Pitot Tube Cover -- REMOVE and check opening for stoppage.
2. Fuel Tank Vent Opening -- CHECK for stoppage.

3. Stall Warning Opening -- CHECK for stoppage. To check the system, place a clean handkerchief over the vent opening and apply suction; a sound from the warning horn will confirm system operation.
4. Wing Tie-Down -- DISCONNECT.
5. Landing Light(s) -- CHECK for condition and cleanliness of cover.

⑧ LEFT WING Trailing Edge

1. Aileron -- CHECK for freedom of movement and security.

BEFORE STARTING ENGINE

1. Preflight Inspection -- COMPLETE.
2. Passenger Briefing -- COMPLETE.
3. Seats, Seat Belts, Shoulder Harnesses -- ADJUST and LOCK.
4. Brakes -- TEST and SET.
5. Avionics Power Switch -- OFF.

CAUTION

The avionics power switch must be OFF during engine start to prevent possible damage to avionics.

6. Circuit Breakers -- CHECK IN.
7. Electrical Equipment, Autopilot (if installed) -- OFF.
8. Fuel Selector Valve -- BOTH.

STARTING ENGINE

1. Prime -- AS REQUIRED (2 to 6 strokes; none if engine is warm).
2. Carburetor Heat -- COLD.
3. Throttle -- OPEN 1/8 INCH.
4. Mixture -- RICH.
5. Propeller Area -- CLEAR.
6. Master Switch -- ON.
7. Ignition Switch -- START (release when engine starts).
8. Oil Pressure -- CHECK.
9. Avionics Power Switch -- ON.
10. Navigation Lights and Flashing Beacon -- ON as required.
11. Radios -- ON.

BEFORE TAKEOFF

1. Parking Brake -- SET.
2. Seats, Seat Belts, Shoulder Harnesses -- CHECK SECURE.
3. Cabin Doors -- CLOSED and LOCKED.
4. Flight Controls -- FREE and CORRECT.
5. Flight Instruments -- CHECK and SET.
6. Fuel Quantity -- CHECK.
7. Mixture -- RICH.
8. Fuel Selector Valve -- RECHECK BOTH.
9. Elevator Trim and Rudder Trim (if installed) -- SET for takeoff.
10. Throttle -- 1700 RPM.
 - a. Magnetos -- CHECK (RPM drop should not exceed 125 RPM on either magneto or 50 RPM differential between magnetos).
 - b. Carburetor Heat -- CHECK (for RPM drop).
 - c. Suction Gage -- CHECK.
 - d. Engine Instruments and Ammeter -- CHECK.
11. Throttle -- 1000 RPM or LESS.
12. Throttle Friction Lock -- ADJUST.
13. Strobe Lights (if installed) -- AS DESIRED.
14. Radios and Avionics -- SET.
15. Autopilot (if installed) -- OFF.
16. Air Conditioner (if installed) -- OFF.
17. Wing Flaps -- SET for takeoff (see Takeoff checklists).
18. Brakes -- RELEASE.

TAKEOFF

NORMAL TAKEOFF

1. Wing Flaps -- 0° - 10°.
2. Carburetor Heat -- COLD.
3. Throttle -- FULL OPEN.
4. Elevator Control -- LIFT NOSE WHEEL (at 55 KIAS).
5. Climb Speed -- 70-80 KIAS.

SHORT FIELD TAKEOFF

1. Wing Flaps -- 10°.
2. Carburetor Heat -- COLD.
3. Brakes -- APPLY.
4. Throttle -- FULL OPEN.
5. Mixture -- RICH (above 3000 feet, LEAN to obtain maximum RPM).
6. Brakes -- RELEASE.
7. Elevator Control -- SLIGHTLY TAIL LOW.
8. Climb Speed -- 56 KIAS (until all obstacles are cleared).

ENROUTE CLIMB

1. Airspeed -- 70-85 KIAS.

NOTE

If a maximum performance climb is necessary, use speeds shown in the Rate Of Climb chart in Section 5.

2. Throttle -- FULL OPEN.
3. Mixture -- RICH (above 3000 feet, LEAN to obtain maximum RPM).

CRUISE

1. Power -- 2100-2700 RPM (no more than 75% is recommended).
2. Elevator and Rudder Trim (if installed) -- ADJUST.
3. Mixture -- LEAN.

DESCENT

1. Fuel Selector Valve -- BOTH.
2. Power -- AS DESIRED.
3. Mixture -- ADJUST for smooth operation (full rich for idle power).
4. Carburetor Heat -- FULL HEAT AS REQUIRED (to prevent carburetor icing).

BEFORE LANDING

1. Seats, Seat Belts, Shoulder Harnesses -- SECURE.
2. Fuel Selector Valve -- BOTH.
3. Mixture -- RICH.
4. Carburetor Heat -- ON (apply full heat before reducing power).
5. Autopilot (if installed) -- OFF.
6. Air Conditioner (if installed) -- OFF.

LANDING

NORMAL LANDING

1. Airspeed -- 65-75 KIAS (flaps UP).
2. Wing Flaps -- AS DESIRED (0°-10° below 110 KIAS, 10°-30° below 85 KIAS).
3. Airspeed -- 60-70 KIAS (flaps DOWN).

**SECTION 4
NORMAL PROCEDURES**

**CESSNA
MODEL 172P**

4. Touchdown -- MAIN WHEELS FIRST.
5. Landing Roll -- LOWER NOSE WHEEL GENTLY.
6. Braking -- MINIMUM REQUIRED.

SHORT FIELD LANDING

1. Airspeed -- 65-75 KIAS (flaps UP).
2. Wing Flaps -- FULL DOWN (30°).
3. Airspeed -- 61 KIAS (until flare).
4. Power -- REDUCE to idle after clearing obstacle.
5. Touchdown -- MAIN WHEELS FIRST.
6. Brakes -- APPLY HEAVILY.
7. Wing Flaps -- RETRACT.

BALKED LANDING

1. Throttle -- FULL OPEN.
2. Carburetor Heat -- COLD.
3. Wing Flaps -- 20° (immediately).
4. Climb Speed -- 55 KIAS.
5. Wing Flaps -- 10° (until obstacles are cleared).
RETRACT (after reaching a safe altitude and 60 KIAS).

AFTER LANDING

1. Carburetor Heat -- COLD.
2. Wing Flaps -- UP.

SECURING AIRPLANE

1. Parking Brake -- SET.
2. Avionics Power Switch, Electrical Equipment, Autopilot (if installed) -- OFF.
3. Mixture -- IDLE CUT-OFF (pulled full out).
4. Ignition Switch -- OFF.
5. Master Switch -- OFF.
6. Control Lock -- INSTALL.

AMPLIFIED PROCEDURES

PREFLIGHT INSPECTION

The Preflight Inspection, described in figure 4-1 and adjacent checklist, is recommended for the first flight of the day. Inspection procedures for subsequent flights are normally limited to brief checks of control surface hinges, fuel and oil quantity, and security of fuel and oil filler caps and draining of the fuel strainer, fuel tank sumps and fuel selector valve. If the airplane has been in extended storage, has had recent major maintenance, or has been operated from marginal airports, a more extensive exterior inspection is recommended.

After major maintenance has been performed, the flight and trim tab controls should be double-checked for free and correct movement and security. The security of all inspection plates on the airplane should be checked following periodic inspections. If the airplane has been waxed or polished, check the external static pressure source hole for stoppage.

If the airplane has been exposed to much ground handling in a crowded hangar, it should be checked for dents and scratches on wings, fuselage, and tail surfaces, as well as damage to navigation and anti-collision lights, and avionics antennas.

Outside storage for long periods may result in dust and dirt accumulation on the induction air filter, obstructions in airspeed system lines, and condensation in fuel tanks. If any water is detected in the fuel system, the fuel tank sump quick-drain valves, fuel selector quick-drain valve, and fuel strainer drain should all be thoroughly drained until there is no evidence of water or sediment contamination. Outside storage in windy or gusty areas, or tie-down adjacent to taxiing airplanes, calls for special attention to control surface stops, hinges, and brackets to detect the presence of wind damage.

If the airplane has been operated from muddy fields or in snow or slush, check the main and nose gear wheel fairings for obstructions and cleanliness. Operation from a gravel or cinder field will require extra attention to propeller tips and abrasion on leading edges of the horizontal tail. Stone damage to the propeller can seriously reduce the fatigue life of the blades.

Airplanes that are operated from rough fields, especially at high altitudes, are subjected to abnormal landing gear abuse. Frequently check all components of the landing gear, shock strut, tires, and brakes. If the shock strut is insufficiently extended, undue landing and taxi loads will be subjected on the airplane structure.

To prevent loss of fuel in flight, make sure the fuel tank filler caps are tightly sealed after any fuel system check or servicing. Fuel system vents should also be inspected for obstructions, ice or water, especially after exposure to cold, wet weather.

STARTING ENGINE

During engine starting, open the throttle approximately 1/8 inch. In warm temperatures, one or two strokes of the primer should be sufficient. In cold weather, up to six strokes of the primer may be necessary. If the engine is warm, no priming will be required. In extremely cold temperatures, it may be necessary to continue priming while cranking the engine.

Weak intermittent firing followed by puffs of black smoke from the exhaust stack indicates overpriming or flooding. Excess fuel can be cleared from the combustion chambers by the following procedure: set the mixture control full lean and the throttle full open; then crank the engine through several revolutions with the starter. Repeat the starting procedure without any additional priming.

If the engine is underprimed (most likely in cold weather with a cold engine) it will not fire at all, and additional priming will be necessary. As soon as the cylinders begin to fire, open the throttle slightly to keep it running.

After starting, if the oil gage does not begin to show pressure within 30 seconds in the summertime and about twice that long in very cold weather, stop engine and investigate. Lack of oil pressure can cause serious engine damage. After starting, avoid the use of carburetor heat unless icing conditions prevail.

NOTE

Additional details concerning cold weather starting and operation may be found under COLD WEATHER OPERATION paragraphs in this section.

TAXIING

When taxiing, it is important that speed and use of brakes be held to a minimum and that all controls be utilized (see Taxiing Diagram, figure 4-2) to maintain directional control and balance.

The carburetor heat control knob should be pushed full in during all ground operations unless heat is absolutely necessary. When the knob is pulled out to the heat position, air entering the engine is not filtered.

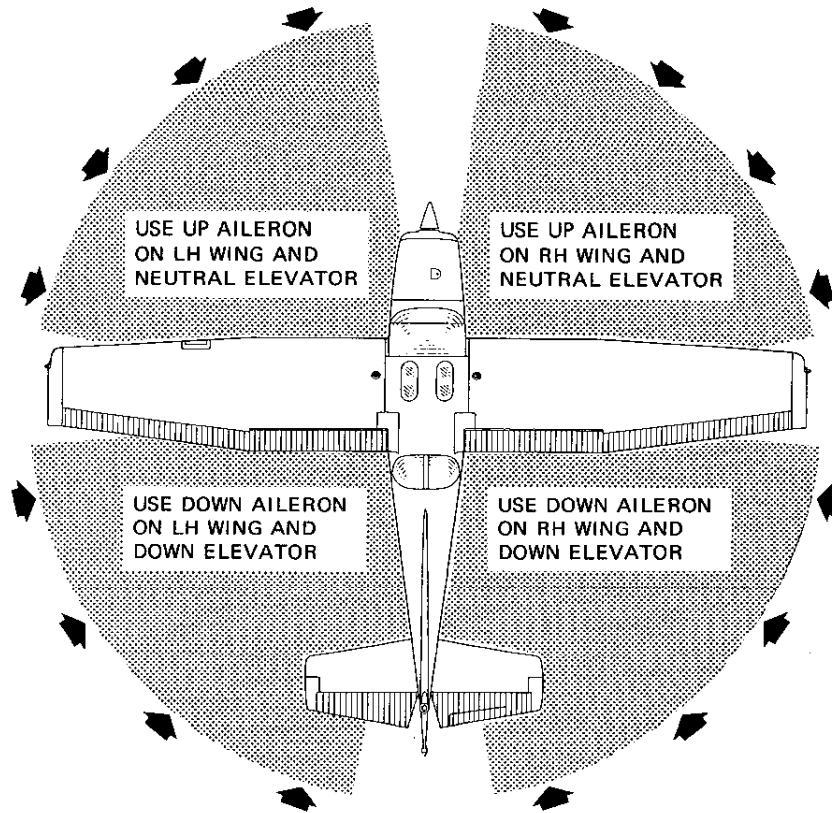

CODE
WIND DIRECTION →

NOTE

Strong quartering tail winds require caution. Avoid sudden bursts of the throttle and sharp braking when the airplane is in this attitude. Use the steerable nose wheel and rudder to maintain direction.

Figure 4-2. Taxiing Diagram

Taxiing over loose gravel or cinders should be done at low engine speed to avoid abrasion and stone damage to the propeller tips.

BEFORE TAKEOFF

WARM-UP

If the engine accelerates smoothly, the airplane is ready for takeoff. Since the engine is closely cowled for efficient in-flight engine cooling, precautions should be taken to avoid overheating during prolonged engine operation on the ground. Also, long periods of idling may cause fouled spark plugs.

MAGNETO CHECK

The magneto check should be made at 1700 RPM as follows. Move ignition switch first to R position and note RPM. Next move switch back to BOTH to clear the other set of plugs. Then move switch to the L position, note RPM and return the switch to the BOTH position. RPM drop should not exceed 125 RPM on either magneto or show greater than 50 RPM differential between magnetos. If there is a doubt concerning operation of the ignition system, RPM checks at higher engine speeds will usually confirm whether a deficiency exists.

An absence of RPM drop may be an indication of faulty grounding of one side of the ignition system or should be cause for suspicion that the magneto timing is set in advance of the setting specified.

ALTERNATOR CHECK

Prior to flights where verification of proper alternator and alternator control unit operation is essential (such as night or instrument flights), a positive verification can be made by loading the electrical system momentarily (3 to 5 seconds) with the landing light or by operating the wing flaps during the engine runup (1700 RPM). The ammeter will remain within a needle width of its initial reading if the alternator and alternator control unit are operating properly.

TAKEOFF

POWER CHECK

It is important to check full-throttle engine operation early in the

takeoff roll. Any sign of rough engine operation or sluggish engine acceleration is good cause for discontinuing the takeoff. If this occurs, you are justified in making a thorough full-throttle static runup before another takeoff is attempted. The engine should run smoothly and turn *approximately 2300 to 2420 RPM with carburetor heat off and mixture leaned to maximum RPM.*

NOTE

Carburetor heat should not be used during takeoff unless it is absolutely necessary for obtaining smooth engine acceleration.

Full-throttle runups over loose gravel are especially harmful to propeller tips. When takeoffs must be made over a gravel surface, it is very important that the throttle be advanced slowly. This allows the airplane to start rolling before high RPM is developed, and the gravel will be blown back of the propeller rather than pulled into it. When unavoidable small dents appear in the propeller blades, they should be immediately corrected as described in Section 8 under Propeller Care.

Prior to takeoff from fields above 3000 feet elevation, the mixture should be leaned to give maximum RPM in a full-throttle, static runup.

After full throttle is applied, adjust the throttle friction lock clockwise to prevent the throttle from creeping back from a maximum power position. Similar friction lock adjustments should be made as required in other flight conditions to maintain a fixed throttle setting.

WING FLAP SETTINGS

Normal takeoffs are accomplished with wing flaps 0° - 10°. Using 10° wing flaps reduces the ground roll and total distance over an obstacle by approximately 10 percent. Flap deflections greater than 10° are not approved for takeoff. If 10° wing flaps are used for takeoff, they should be left down until all obstacles are cleared and a safe flap retraction speed of 60 KIAS is reached. On a short field, 10° wing flaps and an obstacle clearance speed of 56 KIAS should be used.

Soft or rough field takeoffs are performed with 10° flaps by lifting the airplane off the ground as soon as practical in a slightly tail-low attitude. If no obstacles are ahead, the airplane should be leveled off immediately to accelerate to a higher climb speed. When departing a soft field with an aft C.G. loading, the elevator trim should be adjusted towards the nose down direction to give comfortable control wheel forces during the initial climb.

CROSSWIND TAKEOFF

Takeoffs into strong crosswinds normally are performed with the minimum flap setting necessary for the field length, to minimize the drift angle immediately after takeoff. With the ailerons partially deflected into the wind, the airplane is accelerated to a speed slightly higher than normal, then pulled off abruptly to prevent possible settling back to the runway while drifting. When clear of the ground, make a coordinated turn into the wind to correct for drift.

ENROUTE CLIMB

Normal climbs are performed with flaps up and full throttle and at speeds 5 to 10 knots higher than best rate-of-climb speeds for the best combination of performance, visibility and engine cooling. The mixture should be full rich below 3000 feet and may be leaned above 3000 feet for smoother operation or to obtain maximum RPM. For maximum rate of climb, use the best rate-of-climb speeds shown in the Rate-of-Climb chart in Section 5. If an obstruction dictates the use of a steep climb angle, the best angle-of-climb speed should be used with flaps up and maximum power. Climbs at speeds lower than the best rate-of-climb speed should be of short duration to improve engine cooling.

CRUISE

Normal cruising is performed between 55% and 75% power. The engine RPM and corresponding fuel consumption for various altitudes can be determined by using your Cessna Power Computer or the data in Section 5.

NOTE

Cruising should be done at a minimum of 75% power until a total of 25 hours has accumulated or oil consumption has stabilized. Operation at this higher power will ensure proper seating of the rings and is applicable to new engines, and engines in service following cylinder replacement or top overhaul of one or more cylinders.

The Cruise Performance Table, figure 4-3, illustrates the true airspeed and nautical miles per gallon during cruise for various altitudes and percent powers. This table should be used as a guide, along with the available winds aloft information, to determine the most favorable altitude and power setting for a given trip. The selection of cruise altitude on the basis of the most favorable wind conditions and the use of low power settings are significant factors that should be considered on every trip to reduce fuel consumption.

To achieve the recommended lean mixture fuel consumption figures shown in Section 5, the mixture should be leaned until engine RPM peaks and then leaned further until it drops 25-50 RPM. At lower powers it may be necessary to enrichen the mixture slightly to obtain smooth operation.

Should it be necessary to cruise at higher than 75% power, the mixture should not be leaned more than is required to provide peak RPM.

Carburetor ice, as evidenced by an unexplained drop in RPM, can be removed by application of full carburetor heat. Upon regaining the original RPM (with heat off), use the minimum amount of heat (by trial and error) to prevent ice from forming. Since the heated air causes a richer mixture, readjust the mixture setting when carburetor heat is to be used continuously in cruise flight.

The use of full carburetor heat is recommended during flight in heavy rain to avoid the possibility of engine stoppage due to excessive water ingestion or carburetor ice. The mixture setting should be readjusted for smoothest operation. Power changes should be made cautiously, followed by prompt adjustment of the mixture for smoothest operation.

ALTITUDE	75% POWER		65% POWER		55% POWER	
	KTAS	NMPG	KTAS	NMPG	KTAS	NMPG
Sea Level	112	13.3	105	14.4	96	15.4
4000 Feet	116	13.8	108	14.8	98	15.7
8000 Feet	120	14.2	111	15.2	100	16.0
Standard Conditions					Zero Wind	

Figure 4-3. Cruise Performance Table

MIXTURE DESCRIPTION	EXHAUST GAS TEMPERATURE
RECOMMENDED LEAN (Pilot's Operating Handbook and Power Computer)	50° F Rich of Peak EGT
BEST ECONOMY	Peak EGT

Figure 4-4. EGT Table

LEANING WITH A CESSNA ECONOMY MIXTURE INDICATOR (EGT)

Exhaust gas temperature (EGT) as shown on the optional Cessna Economy Mixture Indicator may be used as an aid for mixture leaning in cruising flight at 75% power or less. To adjust the mixture, using this indicator, lean to establish the peak EGT as a reference point and then enrichen the mixture by the desired increment based on figure 4-4.

As noted in this table, operation at peak EGT provides the best fuel economy. This results in approximately 4% greater range than shown in this handbook accompanied by approximately a 3 knot decrease in speed.

Under some conditions, engine roughness may occur while operating at peak EGT. In this case, operate at the Recommended Lean mixture. Any change in altitude or throttle position will require a recheck of EGT indication.

STALLS

The stall characteristics are conventional and aural warning is provided by a stall warning horn which sounds between 5 and 10 knots above the stall in all configurations.

Power-off stall speeds at maximum weight for both forward and aft C.G. positions are presented in Section 5.

SPINS

Intentional spins are approved in this airplane within certain restrict-

ed loadings. Spins with baggage loadings or occupied rear seat(s) are not approved.

However, before attempting to perform spins several items should be carefully considered to assure a safe flight. No spins should be attempted *without first having received dual instruction both in spin entries and spin recoveries* from a qualified instructor who is familiar with the spin characteristics of the Cessna 172P.

The cabin should be clean and all loose equipment (including the microphone and rear seat belts) should be stowed or secured. For a solo flight in which spins will be conducted, the copilot's seat belt and shoulder harness should also be secured. The seat belts and shoulder harnesses should be adjusted to provide proper restraint during all anticipated flight conditions. However, care should be taken to ensure that the pilot can easily reach the flight controls and produce maximum control travels.

It is recommended that, where feasible, entries be accomplished at high enough altitude that recoveries are completed 4000 feet or more above ground level. At least 1000 feet of altitude loss should be allowed for a 1-turn spin and recovery, while a 6-turn spin and recovery may require somewhat more than twice that amount. For example, the recommended entry altitude for a 6-turn spin would be 6000 feet above ground level. In any case, entries should be planned so that recoveries are completed **well above** the minimum 1500 feet above ground level required by FAR 91.71. Another reason for using high altitudes for practicing spins is that a greater field of view is provided which will assist in maintaining pilot orientation.

The normal entry is made from a power-off stall. As the stall is approached, the elevator control should be smoothly pulled to the full aft position. Just prior to reaching the stall "break", rudder control in the desired direction of the spin rotation should be applied so that full rudder deflection is reached almost simultaneously with reaching full aft elevator. A slightly greater rate of deceleration than for normal stall entries, application of ailerons in the direction of the desired spin, and the use of power at the entry will assure more consistent and positive entries to the spin. As the airplane begins to spin, reduce the power to idle and return the ailerons to neutral. Both elevator and rudder controls should be held full with the spin until the spin recovery is initiated. An inadvertent relaxation of either of these controls could result in the development of a nose-down spiral.

For the purpose of training in spins and spin recoveries, a 1 or 2 turn spin is adequate and should be used. Up to 2 turns, the spin will progress to a fairly rapid rate of rotation and a steep attitude. Application of recovery controls will produce prompt recoveries (within 1/4 turn). During ex-

tended spins of two to three turns or more, the spin will tend to change into a spiral, particularly to the right. This will be accompanied by an increase in airspeed and gravity loads on the airplane. If this occurs, recovery should be accomplished quickly by leveling the wings and recovering from the resulting dive.

Regardless of how many turns the spin is held or how it is entered, the following recovery technique should be used:

1. VERIFY THAT THROTTLE IS IN IDLE POSITION AND AILERONS ARE NEUTRAL.
2. APPLY AND **HOLD** FULL RUDDER OPPOSITE TO THE DIRECTION OF ROTATION.
3. JUST **AFTER** THE RUDDER REACHES THE STOP, MOVE THE CONTROL WHEEL **BRISKLY** FORWARD FAR ENOUGH TO BREAK THE STALL.
4. **HOLD** THESE CONTROL INPUTS UNTIL ROTATION STOPS.
5. AS ROTATION STOPS, NEUTRALIZE RUDDER, AND MAKE A SMOOTH RECOVERY FROM THE RESULTING DIVE.

NOTE

If disorientation precludes a visual determination of the direction of rotation, the symbolic airplane in the turn coordinator may be referred to for this information.

Variations in basic airplane rigging or in weight and balance due to installed equipment or right seat occupancy can cause differences in behavior, particularly in extended spins. These differences are normal and will result in variations in the spin characteristics and in the spiraling tendencies for spins of more than 2 turns. However, the recovery technique should always be used and will result in the most expeditious recovery from any spin.

Intentional spins with flaps extended are prohibited, since the high speeds which may occur during recovery are potentially damaging to the flap/wing structure.

LANDING

NORMAL LANDING

Normal landing approaches can be made with power-on or power-off with any flap setting desired. Surface winds and air turbulence are usually the primary factors in determining the most comfortable approach speeds.

Steep slips should be avoided with flap settings greater than 20° due to a slight tendency for the elevator to oscillate under certain combinations of airspeed, sideslip angle, and center of gravity loadings.

NOTE

Carburetor heat should be applied prior to any significant reduction or closing of the throttle.

Actual touchdown should be made with power-off and on the main wheels first to reduce the landing speed and subsequent need for braking in the landing roll. The nose wheel is lowered to the runway gently after the speed has diminished to avoid unnecessary nose gear loads. This procedure is especially important in rough or soft field landings.

SHORT FIELD LANDING

For a short field landing in smooth air conditions, make an approach at 61 KIAS with 30° flaps using enough power to control the glide path. (Slightly higher approach speeds should be used under turbulent air conditions.) After all approach obstacles are cleared, progressively reduce power and maintain the approach speed by lowering the nose of the airplane. Touchdown should be made with power off and on the main wheels first. Immediately after touchdown, lower the nose wheel and apply heavy braking as required. For maximum brake effectiveness, retract the flaps, hold the control wheel full back, and apply maximum brake pressure without sliding the tires.

CROSSWIND LANDING

When landing in a strong crosswind, use the minimum flap setting required for the field length. If flap settings greater than 20° are used in sideslips with full rudder deflection, some elevator oscillation may be felt at normal approach speeds. However, this does not affect control of the airplane. Although the crab or combination method of drift correction may be used, the wing-low method gives the best control. After touchdown, hold a straight course with the steerable nose wheel and occasional braking if necessary.

The maximum allowable crosswind velocity is dependent upon pilot capability as well as aircraft limitations. Operation in direct crosswinds of 15 knots has been demonstrated.

BALKED LANDING

In a bailed landing (go-around) climb, reduce the flap setting to 20° immediately after full power is applied. If obstacles must be cleared during

the go-around climb, reduce the wing flap setting to 10° and maintain a safe airspeed until the obstacles are cleared. Above 3000 feet, lean the mixture to obtain maximum RPM. After clearing any obstacles, the flaps may be retracted as the airplane accelerates to the normal flaps-up climb speed.

COLD WEATHER OPERATION

STARTING

Prior to starting on cold mornings, it is advisable to pull the propeller through several times by hand to "break loose" or "limber" the oil, thus conserving battery energy.

NOTE

When pulling the propeller through by hand, treat it as if the ignition switch is turned on. A loose or broken ground wire on either magneto could cause the engine to fire.

When air temperatures are below 20°F (-6°C), the use of an external preheater and an external power source are recommended whenever possible to obtain positive starting and to reduce wear and abuse to the engine and electrical system. Pre-heat will thaw the oil trapped in the oil cooler, which probably will be congealed prior to starting in extremely cold temperatures. When using an external power source, the position of the master switch is important. Refer to Section 9, Supplements, for Ground Service Plug Receptacle operating details.

Cold weather starting procedures are as follows:

With Preheat:

1. Parking Brake -- SET.
2. Ignition Switch -- OFF.
3. Throttle -- CLOSED.
4. Mixture -- IDLE CUT-OFF.
5. Prime -- 4 TO 8 STROKES as the propeller is being turned over by hand. (Use heavy strokes of primer for best atomization of fuel.)

NOTE

Caution should be used to ensure the brakes are set or a qualified person is at the controls.

6. Primer -- LOCK.

7. Throttle -- OPEN 1/8 INCH.
8. Mixture -- RICH.
9. Propeller Area -- CLEAR.
10. Master Switch -- ON.
11. Ignition Switch -- START (release to BOTH when engine starts).
12. Oil Pressure -- CHECK.

Without Preheat:

1. Parking Brake -- SET.
2. Ignition Switch -- OFF.
3. Throttle -- CLOSED.
4. Mixture -- IDLE CUT-OFF.
5. Prime -- 6 TO 10 STROKES as the propeller is being turned over by hand. Leave the primer charged and ready for a stroke.

NOTE

Caution should be used to ensure the brakes are set or a qualified person is at the controls.

6. Mixture -- RICH.
7. Propeller Area -- CLEAR.
8. Master Switch -- ON.
9. Pump throttle rapidly to full open twice. Return to 1/8 inch open position.
10. Ignition Switch -- START (release to BOTH when engine starts).
11. Continue to prime engine until it is running smoothly, or alternately, pump throttle rapidly over first 1/4 of total travel.
12. Oil Pressure -- CHECK.
13. Pull carburetor heat knob full on after engine has started. Leave on until engine is running smoothly.
14. Primer -- LOCK.

NOTE

If the engine does not start during the first few attempts, or if engine firing diminishes in strength, it is probable that the spark plugs have been frosted over. Preheat must be used before another start is attempted.

CAUTION

Pumping the throttle may cause raw fuel to accumulate in

the intake air duct, creating a fire hazard in the event of a backfire. If this occurs, maintain a cranking action to suck flames into the engine. An outside attendant with a fire extinguisher is advised for cold starts without preheat.

During cold weather operations no indication will be apparent on the oil temperature gage prior to takeoff if outside air temperatures are very cold. After a suitable warm-up period (2 to 5 minutes at 1000 RPM), accelerate the engine several times to higher engine RPM. If the engine accelerates smoothly and the oil pressure remains normal and steady, the airplane is ready for takeoff.

FLIGHT OPERATIONS

Takeoff is made normally with carburetor heat off. Avoid excessive leaning in cruise.

Carburetor heat may be used to overcome any occasional engine roughness due to ice.

When operating in temperatures below -18°C , avoid using partial carburetor heat. Partial heat may increase the carburetor air temperature to the 0° to 21°C range, where icing is critical under certain atmospheric conditions.

HOT WEATHER OPERATION

Refer to the general warm temperature starting information under Starting Engine in this section. Avoid prolonged engine operation on the ground.

NOISE CHARACTERISTICS

Increased emphasis on improving the quality of our environment requires renewed effort on the part of all pilots to minimize the effect of airplane noise on the public.

We, as pilots, can demonstrate our concern for environmental improvement, by application of the following suggested procedures, and thereby tend to build public support for aviation:

1. Pilots operating aircraft under VFR over outdoor assemblies of persons, recreational and park areas, and other noise-sensitive areas should make every effort to fly not less than 2000 feet above the surface, weather permitting, even though flight at a lower level may be consistent with the provisions of government regulations.
2. During departure from or approach to an airport, climb after takeoff and descent for landing should be made so as to avoid prolonged flight at low altitude near noise-sensitive areas.

NOTE

The above recommended procedures do not apply where they would conflict with Air Traffic Control clearances or instructions, or where, in the pilot's judgment, an altitude of less than 2000 feet is necessary for him to adequately exercise his duty to see and avoid other aircraft.

The certificated noise level for the Model 172P at 2400 pounds maximum weight is 73.8 dB(A). No determination has been made by the Federal Aviation Administration that the noise levels of this airplane are or should be acceptable or unacceptable for operation at, into, or out of, any airport.

Notes: _____

SECTION 5 PERFORMANCE

TABLE OF CONTENTS

	Page
Introduction	5-3
Use of Performance Charts	5-3
Sample Problem	5-3
Takeoff	5-4
Cruise	5-5
Fuel Required	5-5
Landing	5-7
Demonstrated Operating Temperature	5-7
Figure 5-1, Airspeed Calibration - Normal Static Source	5-9
Airspeed Calibration - Alternate Static Source	5-10
Figure 5-2, Temperature Conversion Chart	5-11
Figure 5-3, Stall Speeds	5-12
Figure 5-4, Wind Components	5-13
Figure 5-5, Takeoff Distance - 2400 Lbs	5-14
Takeoff Distance - 2200 Lbs and 2000 Lbs	5-15
Figure 5-6, Maximum Rate Of Climb	5-16
Figure 5-7, Time, Fuel, And Distance To Climb	5-17
Figure 5-8, Cruise Performance	5-18
Figure 5-9, Range Profile - 40 Gallons Fuel	5-19
Range Profile - 50 Gallons Fuel	5-20
Range Profile - 62 Gallons Fuel	5-21
Figure 5-10, Endurance Profile - 40 Gallons Fuel	5-22
Endurance Profile - 50 Gallons Fuel	5-23
Endurance Profile - 62 Gallons Fuel	5-24
Figure 5-11, Landing Distance	5-25

Notes: _____

INTRODUCTION

Performance data charts on the following pages are presented so that you may know what to expect from the airplane under various conditions, and also, to facilitate the planning of flights in detail and with reasonable accuracy. The data in the charts has been computed from actual flight tests with the airplane and engine in good condition and using average piloting techniques.

It should be noted that the performance information presented in the range and endurance profile charts allows for 45 minutes reserve fuel at the specified power setting. Fuel flow data for cruise is based on the recommended lean mixture setting. Some indeterminate variables such as mixture leaning technique, fuel metering characteristics, engine and propeller condition, and air turbulence may account for variations of 10% or more in range and endurance. Therefore, it is important to utilize all available information to estimate the fuel required for the particular flight.

USE OF PERFORMANCE CHARTS

Performance data is presented in tabular or graphical form to illustrate the effect of different variables. Sufficiently detailed information is provided in the tables so that conservative values can be selected and used to determine the particular performance figure with reasonable accuracy.

SAMPLE PROBLEM

The following sample flight problem utilizes information from the various charts to determine the predicted performance data for a typical flight. The following information is known:

AIRPLANE CONFIGURATION

Takeoff weight	2350 Pounds
Usable fuel	40 Gallons

TAKEOFF CONDITIONS

Field pressure altitude	1500 Feet
Temperature	28°C (16°C above standard)
Wind component along runway	12 Knot Headwind
Field length	3500 Feet

SECTION 5
PERFORMANCE

CESSNA
MODEL 172P

CRUISE CONDITIONS

Total distance	320 Nautical Miles
Pressure altitude	5500 Feet
Temperature	20°C (16°C above standard)
Expected wind enroute	10 Knot Headwind

LANDING CONDITIONS

Field pressure altitude	2000 Feet
Temperature	25°C
Field length	3000 Feet

TAKEOFF

The takeoff distance chart, figure 5-5, should be consulted, keeping in mind that the distances shown are based on the short field technique. Conservative distances can be established by reading the chart at the next higher value of weight, altitude and temperature. For example, in this particular sample problem, the takeoff distance information presented for a weight of 2400 pounds, pressure altitude of 2000 feet and a temperature of 30°C should be used and results in the following:

Ground roll	1200 Feet
Total distance to clear a 50-foot obstacle	2220 Feet

These distances are well within the available takeoff field length. However, a correction for the effect of wind may be made based on Note 3 of the takeoff chart. The correction for a 12 knot headwind is:

$$\frac{12 \text{ Knots}}{9 \text{ Knots}} \times 10\% = 13\% \text{ Decrease}$$

This results in the following distances, corrected for wind:

Ground roll, zero wind	1200
Decrease in ground roll (1200 feet × 13%)	<u>156</u>
Corrected ground roll	1044 Feet
Total distance to clear a 50-foot obstacle, zero wind	2220
Decrease in total distance (2220 feet × 13%)	<u>289</u>
Corrected total distance to clear 50-foot obstacle	1931 Feet

CRUISE

The cruising altitude should be selected based on a consideration of trip length, winds aloft, and the airplane's performance. A typical cruising altitude and the expected wind enroute have been given for this sample problem. However, the power setting selection for cruise must be determined based on several considerations. These include the cruise performance characteristics presented in figure 5-8, the range profile chart presented in figure 5-9, and the endurance profile chart presented in figure 5-10.

The relationship between power and range is illustrated by the range profile chart. Considerable fuel savings and longer range result when lower power settings are used. For this sample problem, a cruise power of approximately 65% will be used.

The cruise performance chart, figure 5-8, is entered at 6000 feet altitude and 20°C above standard temperature. These values most nearly correspond to the planned altitude and expected temperature conditions. The engine speed chosen is 2500 RPM, which results in the following:

Power	66%
True airspeed	112 Knots
Cruise fuel flow	7.4 GPH

The power computer may be used to determine power and fuel consumption more accurately during the flight.

FUEL REQUIRED

The total fuel requirement for the flight may be estimated using the performance information in figures 5-7 and 5-8. For this sample problem, figure 5-7 shows that a climb from 2000 feet to 6000 feet requires 1.6 gallons of fuel. The corresponding distance during the climb is 10 nautical miles. These values are for a standard temperature and are sufficiently accurate for most flight planning purposes. However, a further correction for the effect of temperature may be made as noted on the climb chart. The approximate effect of a non-standard temperature is to increase the time, fuel, and distance by 10% for each 10°C above standard temperature, due to the lower rate of climb. In this case, assuming a temperature 16°C above standard, the correction would be:

$$\frac{16^{\circ}\text{C}}{10^{\circ}\text{C}} \times 10\% = 16\% \text{ Increase}$$

SECTION 5
PERFORMANCE

CESSNA
MODEL 172P

With this factor included, the fuel estimate would be calculated as follows:

Fuel to climb, standard temperature	1.6
Increase due to non-standard temperature (1.6 × 16%)	<u>0.3</u>
Corrected fuel to climb	1.9 Gallons

Using a similar procedure for the distance to climb results in 12 nautical miles.

The resultant cruise distance is:

Total distance	320
Climb distance	<u>-12</u>
Cruise distance	308 Nautical Miles

With an expected 10 knot headwind, the ground speed for cruise is predicted to be:

112
<u>-10</u>
102 Knots

Therefore, the time required for the cruise portion of the trip is:

$$\frac{308 \text{ Nautical Miles}}{102 \text{ Knots}} = 3.0 \text{ Hours}$$

The fuel required for cruise is:

$$3.0 \text{ hours} \times 7.4 \text{ gallons/hour} = 22.2 \text{ Gallons}$$

A 45-minute reserve requires:

$$\frac{45}{60} \times 7.4 \text{ gallons/hour} = 5.6 \text{ Gallons}$$

The total estimated fuel required is as follows:

Engine start, taxi, and takeoff	1.1
Climb	1.9
Cruise	22.2
Reserve	<u>5.6</u>
Total fuel required	30.8 Gallons

Once the flight is underway, ground speed checks will provide a more accurate basis for estimating the time enroute and the corresponding fuel

required to complete the trip with ample reserve.

LANDING

A procedure similar to takeoff should be used for estimating the landing distance at the destination airport. Figure 5-11 presents landing distance information for the short field technique. The distances corresponding to 2000 feet and 30°C are as follows:

Ground roll	610 Feet
Total distance to clear a 50-foot obstacle	1390 Feet

A correction for the effect of wind may be made based on Note 2 of the landing chart using the same procedure as outlined for takeoff.

DEMONSTRATED OPERATING TEMPERATURE

Satisfactory engine cooling has been demonstrated for this airplane with an outside air temperature 23°C above standard. This is not to be considered as an operating limitation. Reference should be made to Section 2 for engine operating limitations.

AIRSPEED CALIBRATION

NORMAL STATIC SOURCE

CONDITION:
Power required for level flight or maximum rated RPM dive.

FLAPS UP													
KIAS	50	60	70	80	90	100	110	120	130	140	150	160	
KCAS	56	62	70	79	89	98	107	117	126	135	145	154	
FLAPS 10°													
KIAS	40	50	60	70	80	90	100	110	---	---	---	---	---
KCAS	49	55	62	70	79	89	98	108	---	---	---	---	---
FLAPS 30°													
KIAS	40	50	60	70	80	85	---	---	---	---	---	---	---
KCAS	47	53	61	70	80	84	---	---	---	---	---	---	---

Figure 5-1. Airspeed Calibration (Sheet 1 of 2)

**AIRSPEED CALIBRATION
ALTERNATE STATIC SOURCE**

HEATER/VENTS AND WINDOWS CLOSED

FLAPS UP												
NORMAL KIAS	50	60	70	80	90	100	110	120	130	140	---	---
ALTERNATE KIAS	51	61	71	82	91	101	111	121	131	141	---	---
FLAPS 10°												
NORMAL KIAS	40	50	60	70	80	90	100	110	---	---	---	---
ALTERNATE KIAS	40	51	61	71	81	90	99	108	---	---	---	---
FLAPS 30°												
NORMAL KIAS	40	50	60	70	80	85	---	---	---	---	---	---
ALTERNATE KIAS	38	50	60	70	79	83	---	---	---	---	---	---

HEATER/VENTS OPEN AND WINDOWS CLOSED

FLAPS UP												
NORMAL KIAS	40	50	60	70	80	90	100	110	120	130	140	---
ALTERNATE KIAS	36	48	59	70	80	89	99	108	118	128	139	---
FLAPS 10°												
NORMAL KIAS	40	50	60	70	80	90	100	110	---	---	---	---
ALTERNATE KIAS	38	49	59	69	79	88	97	106	---	---	---	---
FLAPS 30°												
NORMAL KIAS	40	50	60	70	80	85	---	---	---	---	---	---
ALTERNATE KIAS	34	47	57	67	77	81	---	---	---	---	---	---

WINDOWS OPEN

FLAPS UP												
NORMAL KIAS	40	50	60	70	80	90	100	110	120	130	140	---
ALTERNATE KIAS	26	43	57	70	82	93	103	113	123	133	143	---
FLAPS 10°												
NORMAL KIAS	40	50	60	70	80	90	100	110	---	---	---	---
ALTERNATE KIAS	25	43	57	69	80	91	101	111	---	---	---	---
FLAPS 30°												
NORMAL KIAS	40	50	60	70	80	85	---	---	---	---	---	---
ALTERNATE KIAS	25	41	54	67	78	84	---	---	---	---	---	---

Figure 5-1. Airspeed Calibration (Sheet 2 of 2)

TEMPERATURE CONVERSION CHART

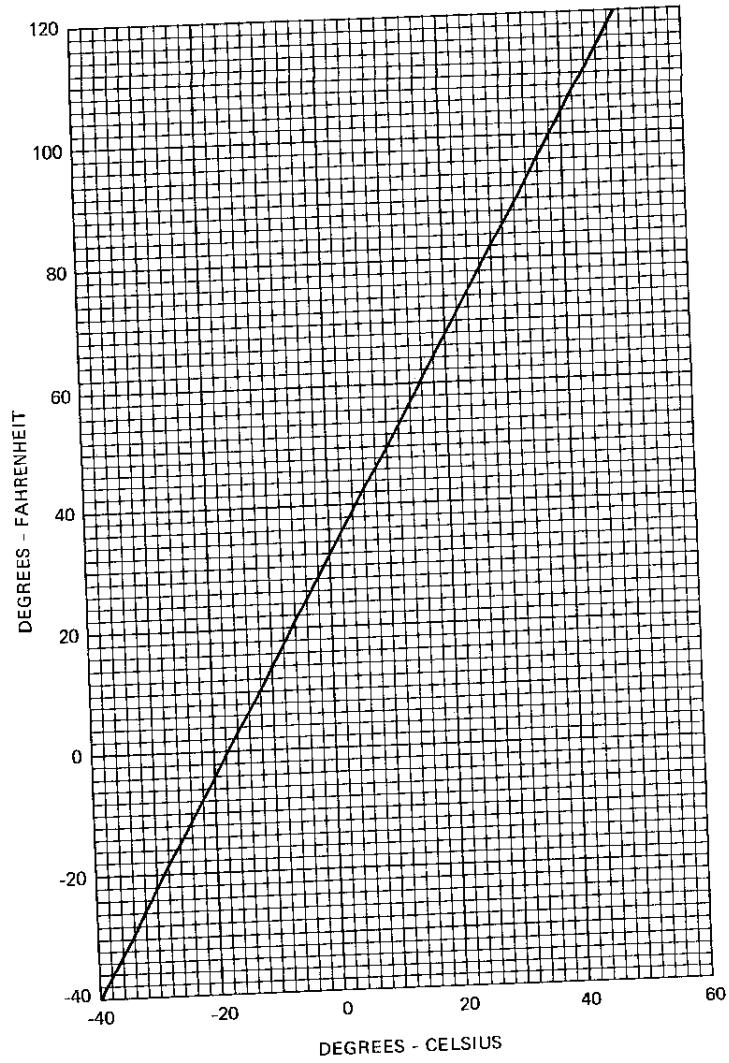

Figure 5-2. Temperature Conversion Chart

STALL SPEEDS

CONDITIONS:
Power Off

NOTES:

1. Altitude loss during a stall recovery may be as much as 230 feet.
2. KIAS values are approximate.

MOST REARWARD CENTER OF GRAVITY

WEIGHT LBS	FLAP DEFLECTION	ANGLE OF BANK							
		0°		30°		45°		60°	
		KIAS	KCAS	KIAS	KCAS	KIAS	KCAS	KIAS	KCAS
2400	UP	44	51	47	55	52	61	62	72
	10°	35	48	38	52	42	57	49	68
	30°	33	46	35	49	39	55	47	65

MOST FORWARD CENTER OF GRAVITY

WEIGHT LBS	FLAP DEFLECTION	ANGLE OF BANK							
		0°		30°		45°		60°	
		KIAS	KCAS	KIAS	KCAS	KIAS	KCAS	KIAS	KCAS
2400	UP	44	52	47	56	52	62	62	74
	10°	37	49	40	53	44	58	52	69
	30°	33	46	35	49	39	55	47	65

Figure 5-3. Stall Speeds

WIND COMPONENTS

NOTE:
Maximum demonstrated crosswind velocity is 15 knots (not a limitation).

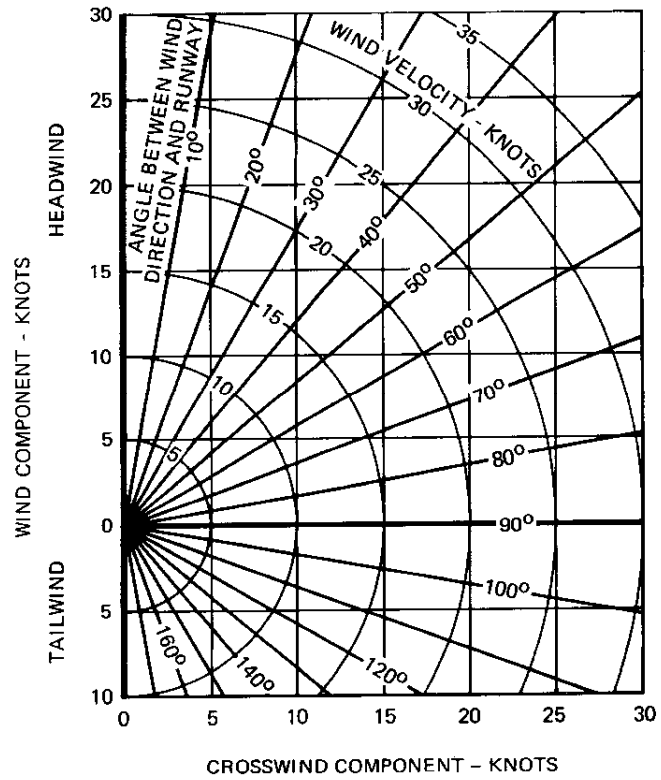

Figure 5-4. Wind Components

**TAKEOFF DISTANCE
MAXIMUM WEIGHT 2400 LBS**

SHORT FIELD

CONDITIONS:

Flaps 10°
Full Throttle Prior to Brake Release
Paved, Level, Dry Runway
Zero Wind

NOTES:

1. Short field technique as specified in Section 4.
2. Prior to takeoff from fields above 3000 feet elevation, the mixture should be leaned to give maximum RPM in a full throttle, static runup.
3. Decrease distances 10% for each 9 knots headwind. For operation with tailwinds up to 10 knots, increase distances by 10% for each 2 knots.
4. For operation on a dry, grass runway, increase distances by 15% of the "ground roll" figure.

WEIGHT LBS	TAKEOFF SPEED KIAS		PRESS ALT FT	0°C			10°C			20°C			30°C			40°C					
	LIFT OFF	AT 50 FT		GRND ROLL	TO CLEAR 50 FT OBS	TOTAL ROLL	GRND ROLL	TO CLEAR 50 FT OBS	TOTAL ROLL	GRND ROLL	TO CLEAR 50 FT OBS	TOTAL ROLL	GRND ROLL	TO CLEAR 50 FT OBS	TOTAL ROLL	GRND ROLL	TO CLEAR 50 FT OBS	TOTAL ROLL			
2400	51	56	S.L.	795	1460	860	1570	925	1685	995	1810	1065	1945	1065	1945	1065	1945	1065	1945		
			1000	875	1605	940	1725	1015	1860	1090	2000	1170	2155	1170	2155	1170	2155	1170	2155		
			2000	960	1770	1035	1910	1115	2060	1200	2220	1290	2395	1290	2395	1290	2395	1290	2395	1290	2395
			3000	1055	1960	1140	2120	1230	2295	1325	2480	1425	2685	1425	2685	1425	2685	1425	2685	1425	2685
			4000	1165	2185	1260	2365	1355	2570	1465	2790	1575	3030	1575	3030	1575	3030	1575	3030	1575	3030
			5000	1285	2445	1390	2660	1500	2895	1620	3160	1745	3455	1745	3455	1745	3455	1745	3455	1745	3455
			6000	1425	2755	1540	3015	1665	3300	1800	3620	1940	3990	1940	3990	1940	3990	1940	3990	1940	3990
			7000	1580	3140	1710	3450	1850	3805	2000	4220	2200	4480	2200	4480	2200	4480	2200	4480	2200	4480
8000	1755	3615	1905	4015	2060	4480	2060	4480	2000	4220	2000	4220	2000	4220	2000	4220	2000	4220			

Figure 5-5. Takeoff Distance (Sheet 1 of 2)

**TAKEOFF DISTANCE
2200 LBS AND 2000 LBS**

SHORT FIELD

REFER TO SHEET 1 FOR APPROPRIATE CONDITIONS AND NOTES.

WEIGHT LBS	TAKEOFF SPEED KIAS		PRESS ALT FT	0°C			10°C			20°C			30°C			40°C				
	LIFT OFF	AT 50 FT		GRND ROLL	TO CLEAR 50 FT OBS	TOTAL	GRND ROLL	TO CLEAR 50 FT OBS	TOTAL	GRND ROLL	TO CLEAR 50 FT OBS	TOTAL	GRND ROLL	TO CLEAR 50 FT OBS	TOTAL	GRND ROLL	TO CLEAR 50 FT OBS	TOTAL		
2200	49	54	S.L.	650	1195	700	1280	750	1375	805	1470	865	1575	865	1575	865	1575	865	1575	
			1000	710	1310	765	1405	825	1510	885	1615	950	1735	950	1735	950	1735	950	1735	
	2000	46	51	2000	780	1440	840	1545	905	1660	975	1785	1045	1915	1045	1915	1045	1915	1045	1915
				3000	855	1585	925	1705	995	1835	1070	1975	1150	2130	1150	2130	1150	2130	1150	2130
				4000	945	1750	1020	1890	1100	2040	1180	2200	1270	2375	1305	2465	1305	2465	1305	2465
				5000	1040	1945	1125	2105	1210	2275	1305	2465	1405	2665	1405	2665	1405	2665	1405	2665
				6000	1150	2170	1240	2355	1340	2555	1445	2775	1555	3020	1555	3020	1555	3020	1555	3020
				7000	1270	2440	1375	2655	1485	2890	1605	3155	1730	3450	1730	3450	1730	3450	1730	3450
				8000	1410	2760	1525	3015	1650	3305	1785	3630	1925	4005	1925	4005	1925	4005	1925	4005
				S.L.	525	970	565	1035	605	1110	650	1185	695	1265	695	1265	695	1265	695	1265
1000	570	1060	615	1135	665	1215	710	1295	765	1385	765	1385	765	1385	765	1385	765	1385		
2000	625	1160	675	1240	725	1330	780	1425	840	1525	840	1525	840	1525	840	1525	840	1525		
3000	690	1270	740	1365	800	1465	860	1570	920	1685	920	1685	920	1685	920	1685	920	1685		
4000	755	1400	815	1500	880	1615	945	1735	1015	1865	1015	1865	1015	1865	1015	1865	1015	1865		
5000	830	1545	900	1660	970	1790	1040	1925	1120	2070	1120	2070	1120	2070	1120	2070	1120	2070		
6000	920	1710	990	1845	1070	1990	1150	2145	1235	2315	1235	2315	1235	2315	1235	2315	1235	2315		
7000	1015	1900	1095	2055	1180	2225	1275	2405	1370	2605	1370	2605	1370	2605	1370	2605	1370	2605		
8000	1125	2125	1215	2305	1310	2500	1410	2715	1520	2950	1520	2950	1520	2950	1520	2950	1520	2950		

Figure 5-5. Takeoff Distance (Sheet 2 of 2)

MAXIMUM RATE OF CLIMB

CONDITIONS:

Flaps Up
Full Throttle

NOTE:

Mixture leaned above 3000 feet for maximum RPM.

WEIGHT LBS	PRESS ALT FT	CLIMB SPEED KIAS	RATE OF CLIMB - FPM			
			-20°C	0°C	20°C	40°C
2400	S.L.	76	805	745	685	625
	2000	75	695	640	580	525
	4000	74	590	535	480	420
	6000	73	485	430	375	320
	8000	72	380	330	275	220
	10,000	71	275	225	175	---
	12,000	70	175	125	---	---

Figure 5-6. Maximum Rate of Climb

TIME, FUEL, AND DISTANCE TO CLIMB

MAXIMUM RATE OF CLIMB

CONDITIONS:

Flaps Up
Full Throttle
Standard Temperature

NOTES:

1. Add 1.1 gallons of fuel for engine start, taxi and takeoff allowance.
2. Mixture leaned above 3000 feet for maximum RPM.
3. Increase time, fuel and distance by 10% for each 10°C above standard temperature.
4. Distances shown are based on zero wind.

WEIGHT LBS	PRESSURE ALTITUDE FT	TEMP °C	CLIMB SPEED KIAS	RATE OF CLIMB FPM	FROM SEA LEVEL		
					TIME MIN	FUEL USED GALLONS	DISTANCE NM
2400	S.L.	15	76	700	0	0.0	0
	1000	13	76	655	1	0.3	2
	2000	11	75	610	3	0.6	4
	3000	9	75	560	5	1.0	6
	4000	7	74	515	7	1.4	9
	5000	5	74	470	9	1.7	11
	6000	3	73	425	11	2.2	14
	7000	1	72	375	14	2.6	18
	8000	-1	72	330	17	3.1	22
	9000	-3	71	285	20	3.6	26
	10,000	-5	71	240	24	4.2	32
	11,000	-7	70	190	29	4.9	38
	12,000	-9	70	145	35	5.8	47

Figure 5-7. Time, Fuel, and Distance to Climb

CRUISE PERFORMANCE

CONDITIONS:
2400 Pounds
Recommended Lean Mixture (See Section 4, Cruise)

PRESSURE ALTITUDE FT	RPM	20°C BELOW STANDARD TEMP			STANDARD TEMPERATURE			20°C ABOVE STANDARD TEMP		
		% BHP	KTAS	GPH	% BHP	KTAS	GPH	% BHP	KTAS	GPH
2000	2500	---	---	---	76	114	8.5	72	114	8.1
	2400	72	110	8.1	69	109	7.7	65	108	7.3
	2300	65	104	7.3	62	103	6.9	59	102	6.6
	2200	58	99	6.6	55	97	6.3	53	96	6.1
	2100	52	92	6.0	50	91	5.8	48	89	5.7
4000	2550	---	---	---	76	117	8.5	72	116	8.1
	2500	77	115	8.6	73	114	8.1	69	113	7.7
	2400	69	109	7.8	65	108	7.3	62	107	7.0
	2300	62	104	7.0	59	102	6.6	57	101	6.4
	2200	56	98	6.3	54	96	6.1	51	94	5.9
	2100	51	91	5.8	48	89	5.7	47	88	5.5
6000	2600	---	---	---	77	119	8.6	72	118	8.1
	2500	73	114	8.2	69	113	7.8	66	112	7.4
	2400	66	108	7.4	63	107	7.0	60	106	6.7
	2300	60	103	6.7	57	101	6.4	55	99	6.2
	2200	54	96	6.1	52	95	5.9	50	92	5.8
	2100	49	90	5.7	47	88	5.5	46	86	5.5
8000	2650	---	---	---	77	121	8.6	73	120	8.1
	2600	77	119	8.7	73	118	8.2	69	117	7.8
	2500	70	113	7.8	66	112	7.4	63	111	7.1
	2400	63	108	7.1	60	106	6.7	58	104	6.5
	2300	57	101	6.4	55	100	6.2	53	97	6.0
	2200	52	95	6.0	50	93	5.8	49	91	5.7
10,000	2600	74	118	8.3	70	117	7.8	66	115	7.4
	2500	67	112	7.5	64	111	7.1	61	109	6.8
	2400	61	106	6.8	58	105	6.5	56	102	6.3
	2300	55	100	6.3	53	98	6.0	51	96	5.9
	2200	50	93	5.8	49	91	5.7	47	89	5.6
12,000	2550	67	114	7.5	64	112	7.1	61	111	6.9
	2500	64	111	7.2	61	109	6.8	59	107	6.6
	2400	59	105	6.6	56	103	6.3	54	100	6.1
	2300	53	98	6.1	51	96	5.9	50	94	5.8

Figure 5-8. Cruise Performance

RANGE PROFILE 45 MINUTES RESERVE 40 GALLONS USABLE FUEL

CONDITIONS:
2400 Pounds
Recommended Lean Mixture for Cruise
Standard Temperature
Zero Wind

NOTE:
This chart allows for the fuel used for engine start, taxi, takeoff and climb, and the distance during climb.

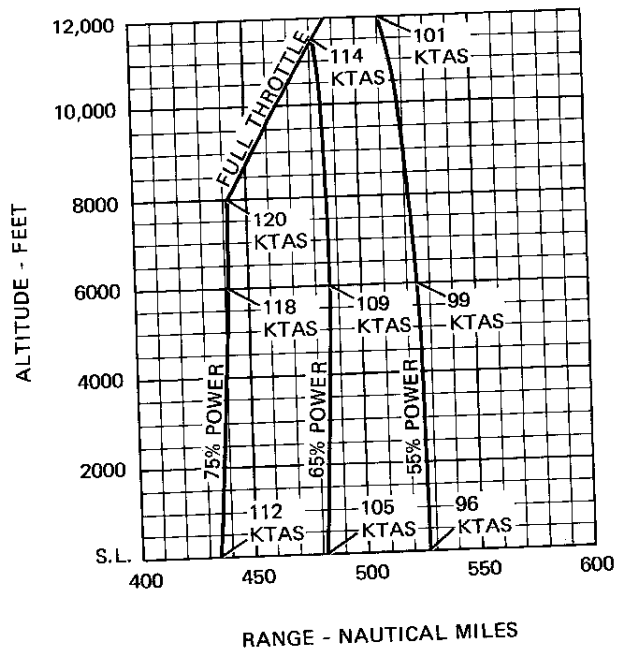

Figure 5-9. Range Profile (Sheet 1 of 3)

RANGE PROFILE 45 MINUTES RESERVE 50 GALLONS USABLE FUEL

CONDITIONS:
2400 Pounds
Recommended Lean Mixture for Cruise
Standard Temperature
Zero Wind

NOTE:
This chart allows for the fuel used for engine start, taxi, takeoff and climb, and the distance during climb.

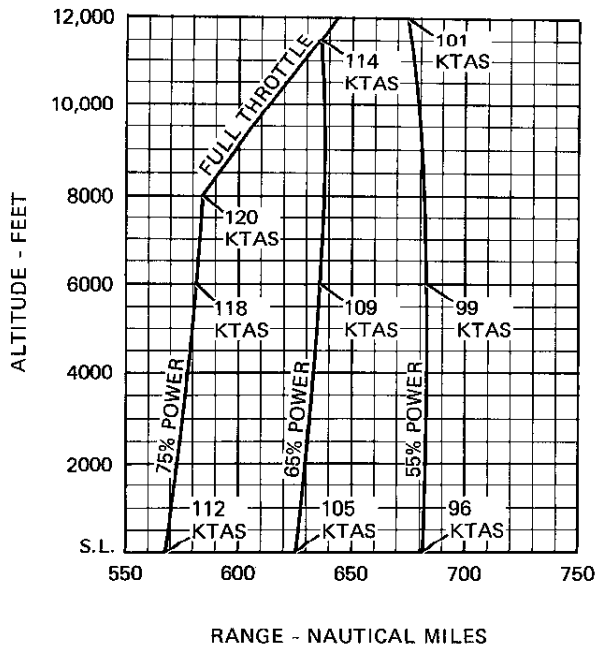

Figure 5-9. Range Profile (Sheet 2 of 3)

RANGE PROFILE 45 MINUTES RESERVE 62 GALLONS USABLE FUEL

CONDITIONS:
2400 Pounds
Recommended Lean Mixture for Cruise
Standard Temperature
Zero Wind

NOTE:
This chart allows for the fuel used for engine start, taxi, takeoff and climb, and the distance during climb.

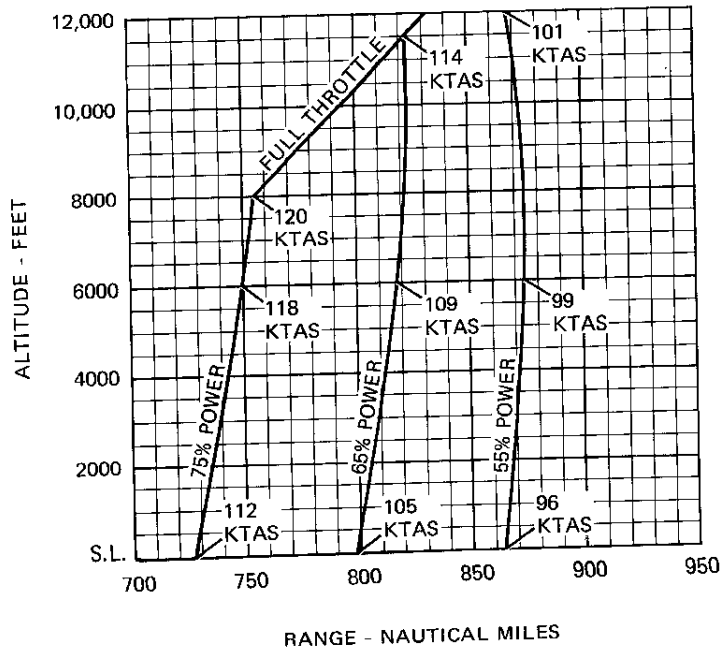

Figure 5-9. Range Profile (Sheet 3 of 3)

ENDURANCE PROFILE

45 MINUTES RESERVE
40 GALLONS USABLE FUEL

CONDITIONS:
2400 Pounds
Recommended Lean Mixture for Cruise
Standard Temperature

NOTE:
This chart allows for the fuel used for engine start, taxi, takeoff and climb, and the time during climb.

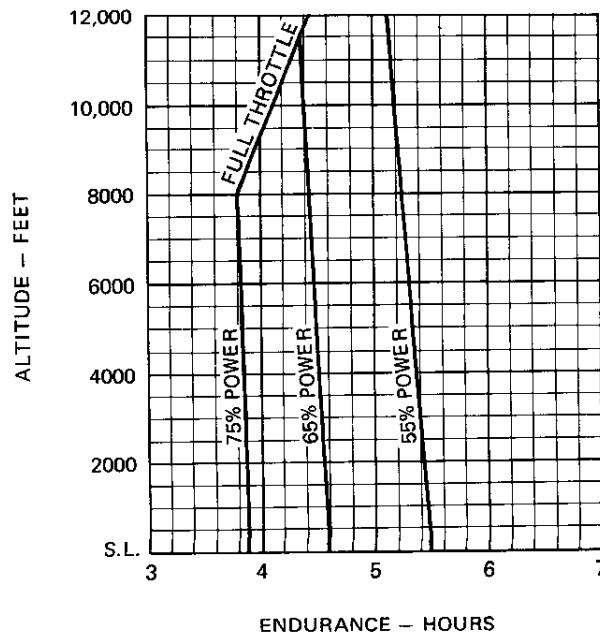

Figure 5-10. Endurance Profile (Sheet 1 of 3)

ENDURANCE PROFILE 45 MINUTES RESERVE 50 GALLONS USABLE FUEL

CONDITIONS:
2400 Pounds
Recommended Lean Mixture for Cruise
Standard Temperature

NOTE:
This chart allows for the fuel used for engine start, taxi, takeoff and climb, and the time during climb.

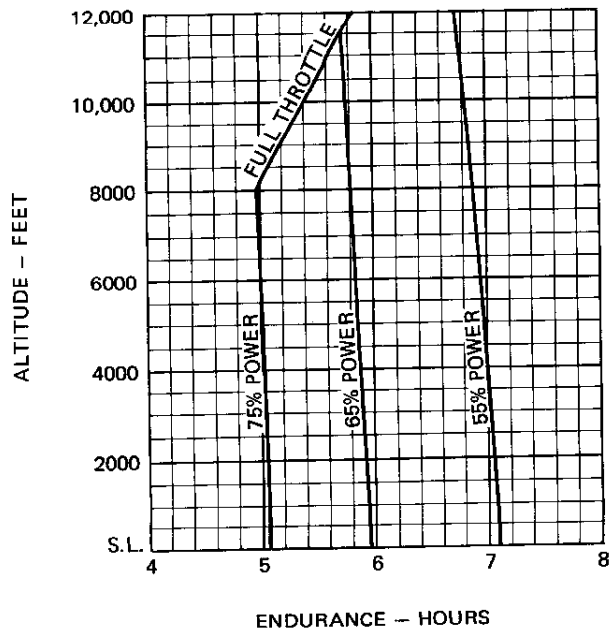

Figure 5-10. Endurance Profile (Sheet 2 of 3)

ENDURANCE PROFILE 45 MINUTES RESERVE 62 GALLONS USABLE FUEL

CONDITIONS:
2400 Pounds
Recommended Lean Mixture for Cruise
Standard Temperature

NOTE:
This chart allows for the fuel used for engine start, taxi, takeoff and climb, and the time during climb.

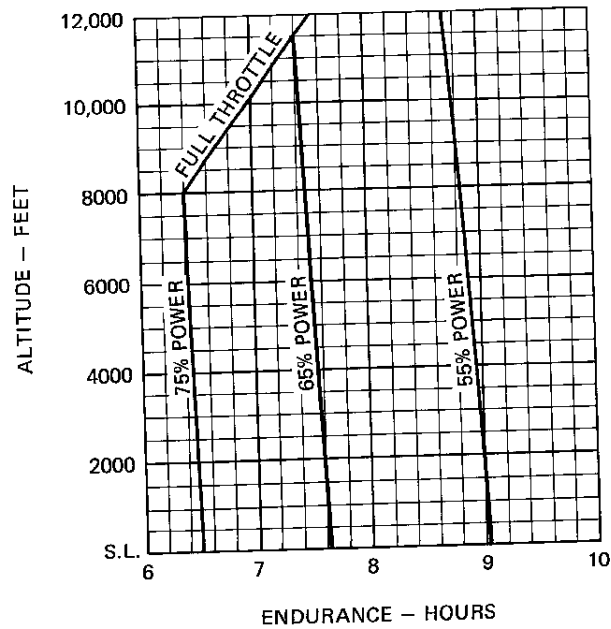

Figure 5-10. Endurance Profile (Sheet 3 of 3)

LANDING DISTANCE

SHORT FIELD

CONDITIONS:

Flaps 30°
Power Off
Maximum Braking
Paved, Level, Dry Runway
Zero Wind

NOTES:

1. Short field technique as specified in Section 4.
2. Decrease distances 10% for each 9 knots headwind. For operation with tailwinds up to 10 knots, increase distances by 10% for each 2 knots.
3. For operation on a dry, grass runway, increase distances by 45% of the "ground roll" figure.
4. If a landing with flaps up is necessary, increase the approach speed by 7 KIAS and allow for 35% longer distances.

WEIGHT LBS	SPEED AT 50 FT KIAS	PRESS ALT FT	0°C			10°C			20°C			30°C			40°C		
			GRND ROLL	TO CLEAR 50 FT OBS	TOTAL	GRND ROLL	TO CLEAR 50 FT OBS	TOTAL	GRND ROLL	TO CLEAR 50 FT OBS	TOTAL	GRND ROLL	TO CLEAR 50 FT OBS	TOTAL	GRND ROLL	TO CLEAR 50 FT OBS	TOTAL
2400	61	S.L.	510	1235	1265	530	1265	1295	550	1295	1325	570	1325	1360	590	1360	1390
		1000	530	1265	1295	550	1295	1330	570	1330	1360	590	1360	1390	610	1390	1425
		2000	550	1295	1330	570	1330	1360	590	1360	1395	615	1395	1430	635	1430	1460
		3000	570	1330	1360	590	1360	1400	615	1400	1430	660	1430	1470	680	1470	1500
		4000	595	1365	1400	615	1400	1435	640	1435	1470	685	1470	1510	705	1510	1540
		5000	615	1400	1435	640	1435	1470	660	1470	1510	710	1510	1550	735	1550	1580
		6000	640	1435	1470	660	1470	1515	680	1515	1550	740	1550	1590	760	1590	1630
		8000	690	1475	1515	715	1515	1555	740	1555	1595	765	1595	1635	790	1635	1675

Figure 5-11. Landing Distance

Notes: _____

CESSNA
MODEL 172P

SECTION 6
WEIGHT & BALANCE/
EQUIPMENT LIST

SECTION 6 WEIGHT & BALANCE/ EQUIPMENT LIST

TABLE OF CONTENTS

	Page
Introduction	6-3
Airplane Weighing Procedures	6-3
Weight And Balance	6-7
Equipment List	6-15

12 May 1981

6-1/(6-2 blank)

Notes: _____

INTRODUCTION

This section describes the procedure for establishing the basic empty weight and moment of the airplane. Sample forms are provided for reference. Procedures for calculating the weight and moment for various operations are also provided. A comprehensive list of all Cessna equipment available for this airplane is included at the back of this section.

It should be noted that specific information regarding the weight, arm, moment and installed equipment for this airplane as delivered from the factory can only be found in the plastic envelope carried in the back of this handbook.

It is the responsibility of the pilot to ensure that the airplane is loaded properly.

AIRPLANE WEIGHING PROCEDURES

1. Preparation:
 - a. Inflate tires to recommended operating pressures.
 - b. Remove fuel tank sump quick-drain fittings and use sampler cup at quick-drain in fuel selector valve to drain all fuel.
 - c. Service engine oil as required to obtain a normal full indication.
 - d. Move sliding seats to the most forward position.
 - e. Raise flaps to the fully retracted position.
 - f. Place all control surfaces in neutral position.
2. Leveling:
 - a. Place scales under each wheel (minimum scale capacity, 500 pounds nose, 1000 pounds each main).
 - b. Deflate the nose tire and/or lower or raise the nose strut to properly center the bubble in the level (see figure 6-1).
3. Weighing:
 - a. With the airplane level and brakes released, record the weight shown on each scale. Deduct the tare, if any, from each reading.
4. Measuring:
 - a. Obtain measurement A by measuring horizontally (along the airplane center line) from a line stretched between the main wheel centers to a plumb bob dropped from the firewall.
 - b. Obtain measurement B by measuring horizontally and parallel to the airplane center line, from center of nose wheel axle, left side, to a plumb bob dropped from the line between the main wheel centers. Repeat on right side and average the measurements.
5. Using weights from item 3 and measurements from item 4, the airplane weight and C.G. can be determined.
6. Basic Empty Weight may be determined by completing figure 6-1.

**SECTION 6
WEIGHT & BALANCE/
EQUIPMENT LIST**

**CESSNA
MODEL 172P**

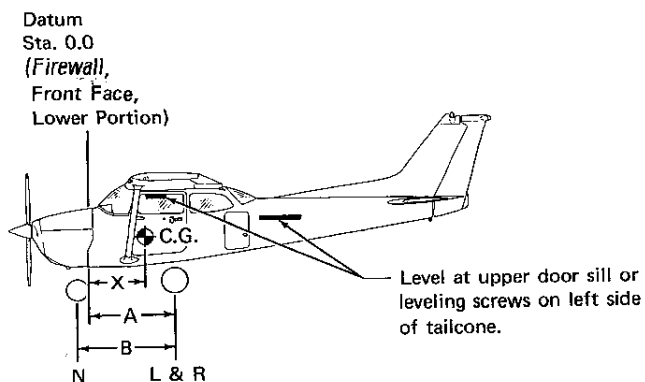

Scale Position	Scale Reading	Tare	Symbol	Net Weight
Left Wheel			L	
Right Wheel			R	
Nose Wheel			N	
Sum of Net Weights (As Weighed)			W	

$$X = \text{ARM} = \frac{(A) - (N) \times (B)}{W}; X = (\quad) - \frac{(\quad) \times (\quad)}{(\quad)} = (\quad) \text{ IN.}$$

Item	Weight (Lbs.)	X C.G. Arm (In.)	Moment/1000 (Lbs.-In.)
Airplane Weight (From Item 5, page 6-3)			
Add Unusable Fuel:			
Std. Tanks (3 Gal at 6 Lbs/Gal)		46.0	
L.R. Tanks (4 Gal at 6 Lbs/Gal)		46.0	
Integral Tanks (6 Gal at 6 Lbs/Gal)		46.0	
Equipment Changes			
Airplane Basic Empty Weight			

Figure 6-1. Sample Airplane Weighing

SAMPLE WEIGHT AND BALANCE RECORD

(Continuous History of Changes in Structure or Equipment Affecting Weight and Balance)

AIRPLANE MODEL			SERIAL NUMBER				PAGE NUMBER		
DATE	ITEM NO.		DESCRIPTION OF ARTICLE OR MODIFICATION	ADDED (+)		REMOVED (-)		RUNNING BASIC EMPTY WEIGHT	
	In	Out		Arm (In.)	Moment /1000	Wt. (lb.)	Arm (In.)	Moment /1000	Wt. (lb.)
			As delivered						

Figure 6-2. Sample Weight and Balance Record

Notes: _____

WEIGHT AND BALANCE

The following information will enable you to operate your Cessna within the prescribed weight and center of gravity limitations. To figure weight and balance, use the Sample Problem, Loading Graph, and Center of Gravity Moment Envelope as follows:

Take the basic empty weight and moment from appropriate weight and balance records carried in your airplane, and enter them in the column titled YOUR AIRPLANE on the Sample Loading Problem.

NOTE

In addition to the basic empty weight and moment noted on these records, the C.G. arm (fuselage station) is also shown, but need not be used on the Sample Loading Problem. The moment which is shown must be divided by 1000 and this value used as the moment/1000 on the loading problem.

Use the Loading Graph to determine the moment/1000 for each additional item to be carried; then list these on the loading problem.

NOTE

Loading Graph information for the pilot, passengers and baggage is based on seats positioned for average occupants and baggage loaded in the center of the baggage areas as shown on the Loading Arrangements diagram. For loadings which may differ from these, the Sample Loading Problem lists fuselage stations for these items to indicate their forward and aft C.G. range limitations (seat travel and baggage area limitation). Additional moment calculations, based on the actual weight and C.G. arm (fuselage station) of the item being loaded, must be made if the position of the load is different from that shown on the Loading Graph.

Total the weights and moments/1000 and plot these values on the Center of Gravity Moment Envelope to determine whether the point falls within the envelope, and if the loading is acceptable.

LOADING ARRANGEMENTS

*Pilot or passenger center of gravity on adjustable seats positioned for average occupant. Numbers in parentheses indicate forward and aft limits of occupant center of gravity range.
**Arm measured to the center of the areas shown.

- NOTES:
1. The usable fuel C.G. arm for standard, long range and integral tanks is located at station 48.0.
 2. The rear cabin wall (approximate station 108) or aft baggage wall (approximate station 142) can be used as convenient interior reference points for determining the location of baggage area fuselage stations.

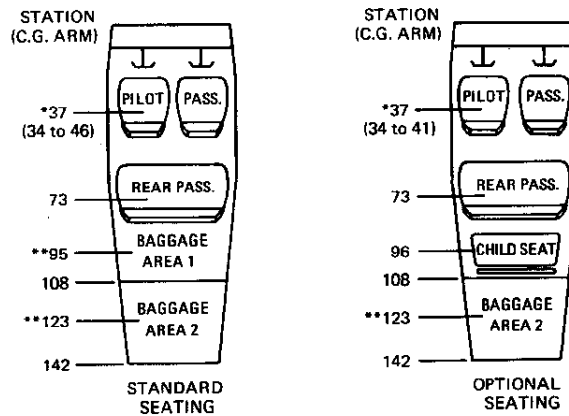

Figure 6-3. Loading Arrangements

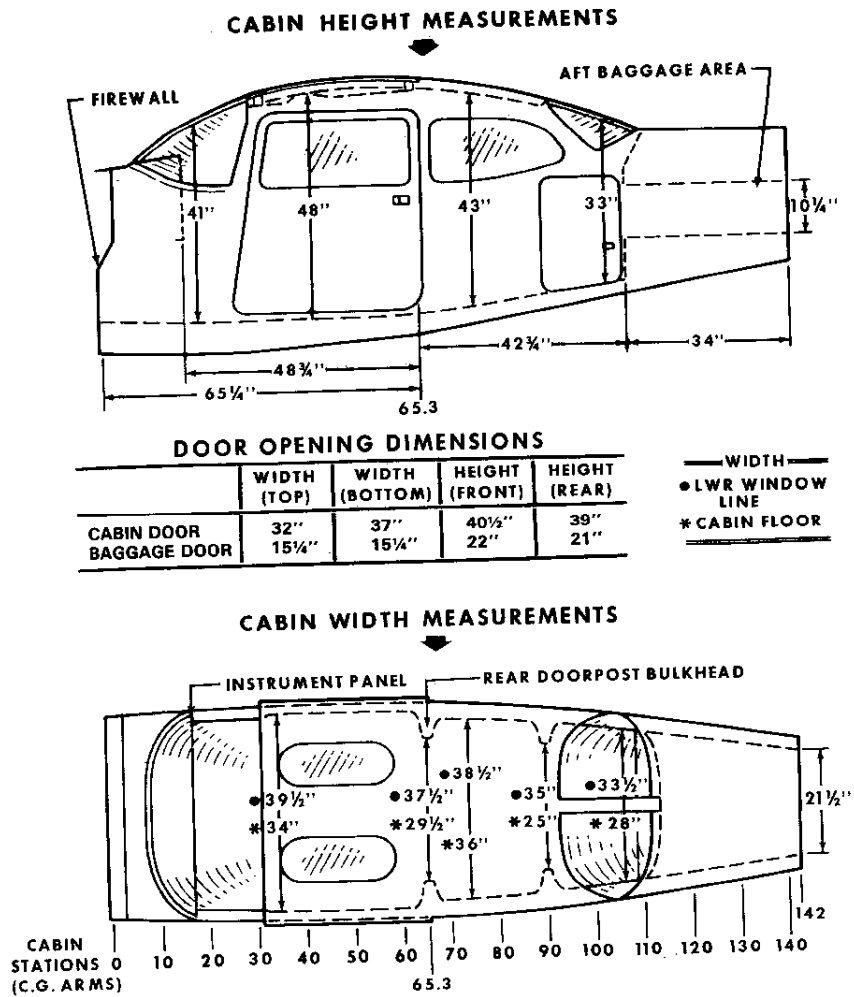

Figure 6-4. Internal Cabin Dimensions

SECTION 6
WEIGHT & BALANCE/
EQUIPMENT LIST

CESSNA
MODEL 172P

SAMPLE LOADING PROBLEM	SAMPLE AIRPLANE		YOUR AIRPLANE	
	Weight (lbs.)	Moment (lb.-ins. /1000)	Weight (lbs.)	Moment (lb.-ins. /1000)
1. Basic Empty Weight (Use the data pertaining to your airplane as it is presently equipped. Includes unusable fuel and full oil)	1467	57.3		
2. Usable Fuel (At 6 Lbs./Gal.)				
Standard Tanks (40 Gal. Maximum)	240	11.5		
Long Range Tanks (50 Gal. Maximum)				
Integral Tanks (62 Gal. Maximum)				
Integral Reduced Fuel (42 Gal.)				
3. Pilot and Front Passenger (Station 34 to 46)	340	12.6		
4. Rear Passengers	340	24.8		
5. * Baggage Area 1 or Passenger on Child's Seat (Station 82 to 108, 120 Lbs. Max.)	20	1.9		
6. * Baggage Area 2 (Station 108 to 142, 50 Lbs. Max.)				
7. RAMP WEIGHT AND MOMENT	2407	108.1		
8. Fuel allowance for engine start, taxi, and runup	- 7	- .3		
9. TAKEOFF WEIGHT AND MOMENT (Subtract Step 8 from Step 7)	2400	107.8		
10. Locate this point (2400 at 107.8) on the Center of Gravity Moment Envelope, and since this point falls within the envelope, the loading is acceptable. * The maximum allowable combined weight capacity for baggage areas 1 and 2 is 120 pounds.				

Figure 6-5. Sample Loading Problem (Sheet 1 of 2)

YOUR AIRPLANE		YOUR AIRPLANE		YOUR AIRPLANE		YOUR AIRPLANE	
Weight (lbs.)	Moment (lb.-ins. /1000)	Weight (lbs.)	Moment (lb.-ins. /1000)	Weight (lbs.)	Moment (lb.-ins. /1000)	Weight (lbs.)	Moment (lb.-ins. /1000)

When several loading configurations are representative of your operations, it may be useful to fill out one or more of the above columns so that specific loadings are available at a glance.

Figure 6-5. Sample Loading Problem (Sheet 2 of 2)

SECTION 6
WEIGHT & BALANCE/
EQUIPMENT LIST

CESSNA
MODEL 172P

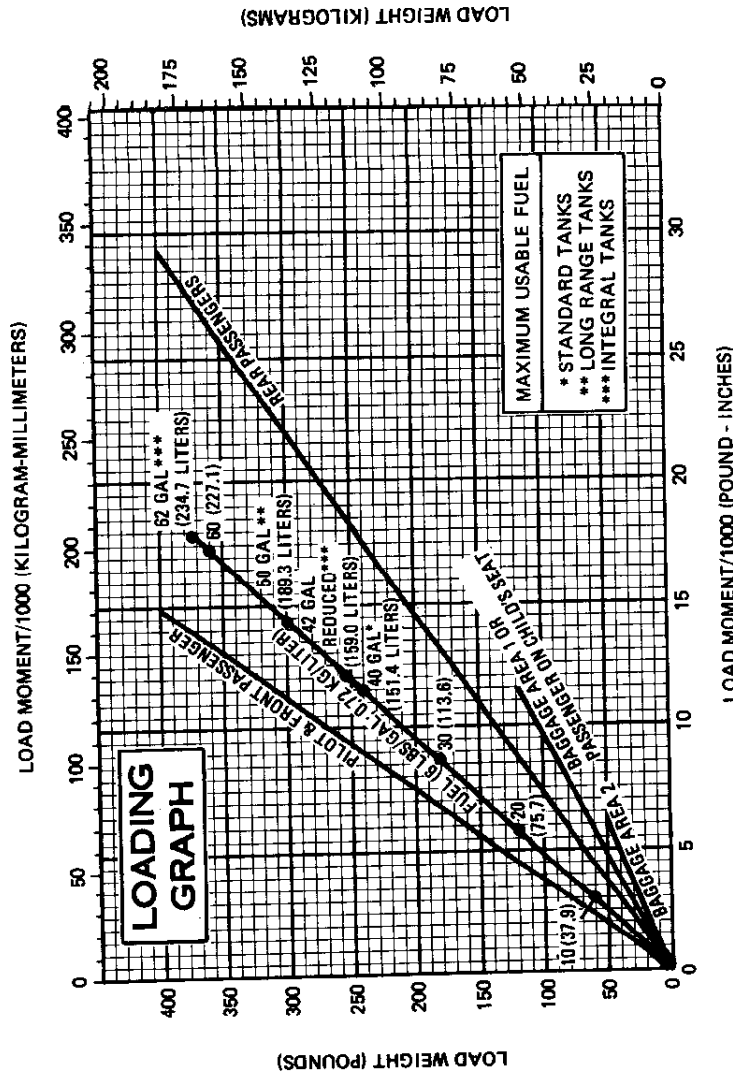

NOTE: Line representing adjustable seats shows the pilot or passenger center of gravity on adjustable seats positioned for an average occupant. Refer to the Loading Arrangements diagram for forward and aft limits of occupant C.G. range.

Figure 6-6. Loading Graph

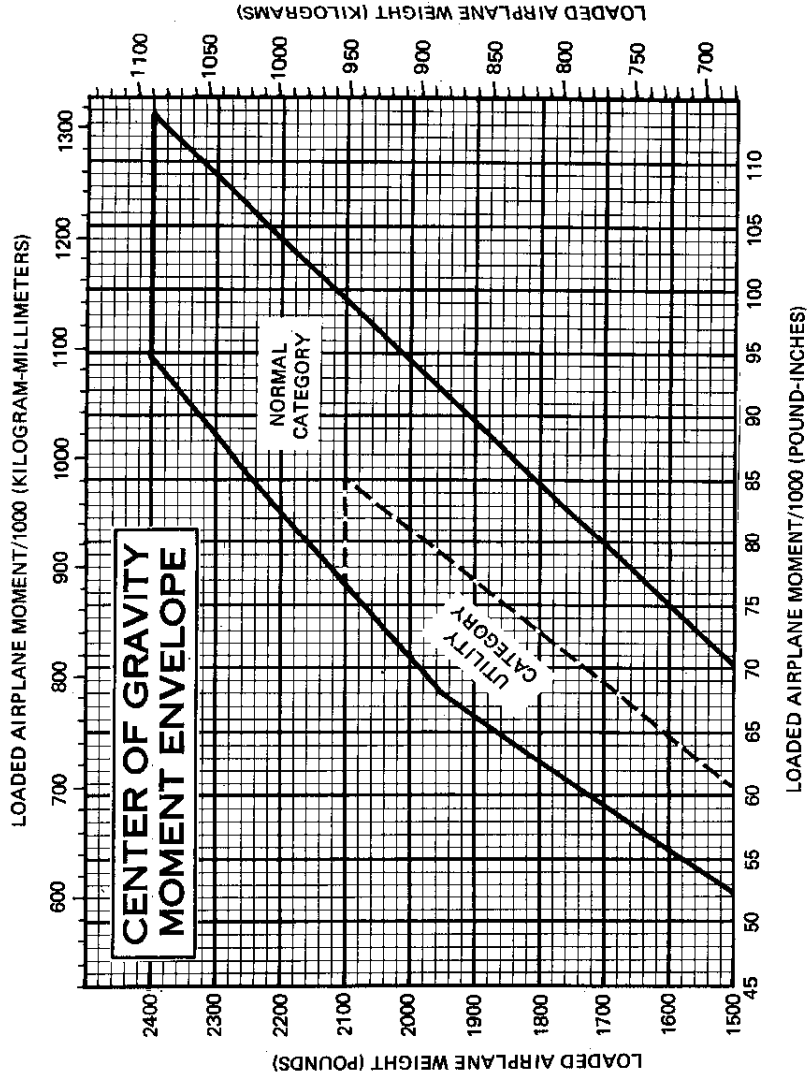

Figure 6-7. Center of Gravity Moment Envelope

SECTION 6
WEIGHT & BALANCE/
EQUIPMENT LIST

CESSNA
MODEL 172P

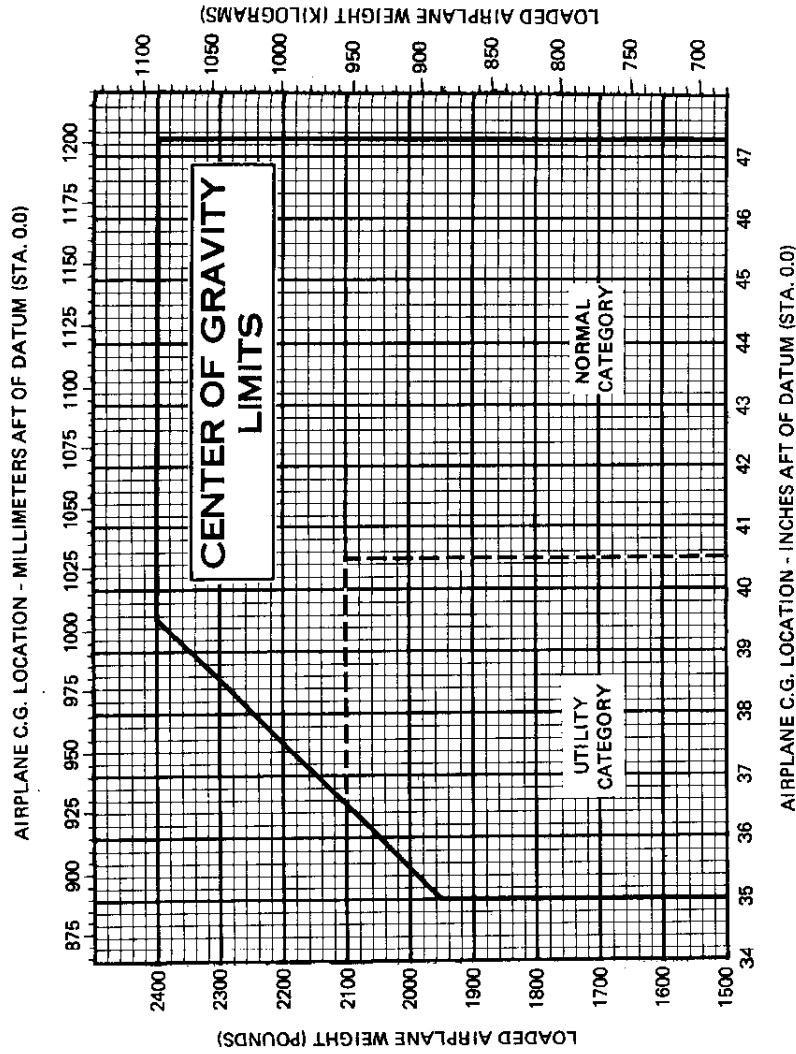

Figure 6-8. Center of Gravity Limits

EQUIPMENT LIST

The following equipment list is a comprehensive list of all Cessna equipment available for this airplane. A separate equipment list of items installed in your specific airplane is provided in your aircraft file. The following list and the specific list for your airplane have a similar order of listing.

This equipment list provides the following information:

An **item number** gives the identification number for the item. Each number is prefixed with a letter which identifies the **descriptive** grouping (example: A. Powerplant & Accessories) under which it is listed. Suffix letters identify the equipment as a required item, a standard item or an optional item. Suffix letters are as follows:

- R = required items of equipment for FAA certification
- S = standard equipment items
- O = optional equipment items replacing required or standard items
- A = optional equipment items which are in addition to required or standard items

A **reference drawing** column provides the drawing number for the item.

NOTE

If additional equipment is to be installed, it must be done in accordance with the reference drawing, accessory kit instructions, or a separate FAA approval.

Columns showing **weight (in pounds)** and **arm (in inches)** provide the weight and center of gravity location for the equipment.

NOTE

Unless otherwise indicated, true values (not net change values) for the weight and arm are shown. Positive arms are distances aft of the airplane datum; negative arms are distances forward of the datum.

NOTE

Asterisks (*) after the item weight and arm indicate complete assembly installations. Some major components of the assembly are listed on the lines immediately following. The summation of these major components does not necessarily equal the complete assembly installation.

SECTION 6
WEIGHT & BALANCE/
EQUIPMENT LIST

CESSNA
MODEL 172P

ITEM NO	EQUIPMENT LIST DESCRIPTION	REF DRAWING	WT LBS	ARM INS
	A. POWERPLANT & ACCESSORIES			
A01-R	ENGINE LYCOMING O-320-D2J (INCLUDES ELECTRIC STARTER, VACUUM PAD, SPARK PLUGS, TWO MAGNETOS AND OIL FILTER)	0550319	281.5	-19.6
A05-R	FILTER, CARBURETOR AIR	C294510-0301	0.5	-26.0
A09-R	ALTERNATOR, 28 VOLT, 60 AMP	C611503-0102	10.7	-29.0
A17-R	OIL COOLER INSTALLATION --OIL COOLER	0550319 8406J	3.3* 2.3	-10.2* -11.7
A33-R	PROPELLER ASSY. (FIXED PITCH-LANDPLANE) --PROPELLER (MCCALLEY) --PROP SPACER ADAPTER	C161001-0310 C16160/DTM7557 C4516	34.6* 30.1 3.6	-38.3* -38.7 -35.5
A33-O	PROPELLER ASSY. (FIXED PITCH-FLATPLANE) --PROPELLER (MCCALLEY) --PROP SPACER ADAPTER	C161001-0307 C16175/ETM8042 C4516	37.5* 31.8 3.6	-38.3* -38.7 -35.5
A41-R	SPINNER INSTALLATION, PROPELLER --SPINNER DOME ASSY --FWD SPINNER BULKHEAD --AFT SPINNER BULKHEAD	0550320 0550236-8 0550321-4 0550321-10	2.0* 1.2 0.3 0.4	-41.4* -42.1 -40.8 -37.3
A61-S	VACUUM PUMP INSTALLATION --VACUUM PUMP --FILTER INSTL --VACUUM GAUGE --RELIEF VALVE	0501054 C431003-0101 1201075-2 C688509-0101 C482001-0401	3.0* 1.8 0.2 0.1 0.4	-2.7* -6.3 5.4 16.7 15.0
A70-A	PRIMER SYSTEM, ENGINE THREE CYLINDER	0501056-1	0.5	-11.7
A73-A	OIL QUICK DRAIN VALVE (NET CHANGE)	1701015-2	NEGL	--
	B. LANDING GEAR & ACCESSORIES			

ITEM NO	EQUIPMENT LIST DESCRIPTION	REF DRAWING	WT LBS	ARM INS
B01-R	WHEEL, BRAKE & TIRE ASSY, 6.00X6 MAIN (2) -WHEEL ASSY., MCCAULEY (EACH) -BRAKE ASSY., MCCAULEY (LEFT) -BRAKE ASSY., MCCAULEY (RIGHT) -TIRE, 4 PLY BLACKWALL (EACH) -TUBE	C163019-0201 C163006-0101 C163033-0101 C163033-0101 C262003-0101 C262023-0102	39.8* 7.6 1.8 1.8 8.4 2.1	57.8* 58.2 54.5 54.5 58.2 58.2
B04-R	WHEEL & TIRE ASSY., 5.00X5 NOSE -WHEEL ASSY., MCCAULEY -TIRE, 6 PLY BLACKWALL -TUBE	C163018-0104 C163005-0201 C262003-0202 C262023-0101	10.4* 3.8 3.2 1.4	-6.8* -6.8 -6.8 -6.8
B10-S	FAIRING INSTALLATION -NOSE WHEEL FAIRING (2) -MAIN WHEEL FAIRING (2) -BRAKE FAIRINGS (2)	0541225-1 0543079-11 0541223 0541224	16.5* 4.0 11.4 1.1	44.3* -4.9 60.3 55.0
C. ELECTRICAL SYSTEMS				
C01-R	BATTERY, 24 VOLT, STANDARD DUTY	C614002-0101	23.2	-5.0
C01-O	BATTERY, 24 VOLT, HEAVY DUTY	C614002-0102	25.2	-5.0
C04-R	ALTERNATOR CONTROL UNIT, 28 VOLT W/HIGH PROTECTION & LOW SENSING	C611005-0101	0.4	3.5
C07-A	GROUND SERVICE PLUG RECEPTACLE	0501104-1	3.1	-2.6
C16-O	HEATING SYSTEM, PITOT (NET CHANGE)	0422355-8	0.6	24.4
C22-A	LIGHTS, INSTRUMENT POST (REQUIRES E34-O DELUXE GLARE SHIELD INSTL.)	0513094-23	0.5	16.5
C25-A	MAP LIGHT INSTL., CONTROL WHEEL MOUNTED (REQUIRED W/E89-B ONLY)	0570087-1	0.2	21.5
C28-S	LIGHT INSTL., MAP & INSTRUMENT PANEL FLOOD (DOORPOST MOUNTED)	0700149	0.3	32.0

SECTION 6
WEIGHT & BALANCE/
EQUIPMENT LIST

CESSNA
MODEL 172P

ITEM NO	EQUIPMENT LIST DESCRIPTION	REF DRAWING	WT LBS	ARM INS
C31-A	LIGHTS, COURTESY ENTRANCE (SET OF 2)	0521101-1	0.5	61.0
C40-A	DETECTORS, NAVIGATION LIGHT (SET OF 2)	0701013-1, -2	NEGL	--
C43-A	LIGHT INSTALLATION; OMNIFLASH BEACON -BEACON LIGHT ON FIN TIP -FLASHER POWER SUPPLY -RESISTOR (MEMCOR) -MISC. HARDWARE	0506003-5 C621001-0102 C594502-0102 DR95-6	1.4* 0.4 0.6 0.2 0.2	204.7* 242.5 205.1 208.3 124.3
C46-A	LIGHT INSTALLATION; WING TIP STROBE -POWER SUPPLY (SET OF 2) -STROBE LIGHTS (SET OF 2) -WIRING & MISC. HARDWARE	0501027-4 C622008-0102 C622006-0107	3.4* 2.3 0.2 0.9	43.3* 47.0 43.5 33.0
C49-S	LANDING & TAXI LIGHT INSTL.; WING MOUNTED -LAMP 250 WATT (G.E.) LANDING -LAMP 250 WATT (G.E.) TAXI -WIRING & HARDWARE	4596 4587	2.2* 0.5 0.5 1.2	25.3* 29.0 29.0 22.2
	D. INSTRUMENTS			
D01-R	INDICATOR, AIRSPEED	C661064-0102	0.6	16.2
D01-O	INDICATOR, TRUE AIRSPEED	0513279-5	0.7	16.3
D04-A	STATIC AIR ALTERNATE SOURCE	0501017-1	0.2	15.5
D07-R	ALTIMETER (SENSITIVE)	C661071-0101	0.9	14.0
D07-O-1	ALTIMETER (FEET AND MILLIBARS) (SENSITIVE WITH 50 FT MARKINGS)	C661071-0102	0.8	14.0
D07-O-2	ALTIMETER (FEET AND MILLIBARS) (SENSITIVE WITH 20 FT MARKINGS)	C661025-0102	0.7	14.0
D10-A	ALTIMETER; 2ND UNIT INSTALLATION (DUAL)	2001015	0.8	14.5

ITEM NO	EQUIPMENT LIST DESCRIPTION	REF DRAWING	WT LBS	ARM INS
D16-A-1	ENCODING ALTIMETER (REQUIRES RELOCATION OF REGULAR ALTIMETER)	0501049	3.0	14.0
D16-A-2	ENCODING ALTIMETER, (FEET & MILLIBARS) (REQUIRES RELOCATION OF REGULAR ALTIMETER)	0501049	3.0	14.0
D16-A-3	ALTITUDE ENCODER (BLIND, DOES NOT REQUIRE INSTRUMENT PANEL MOUNTING)	0511085	1.5	14.4
D19-R	ANMETER	S-1320-5	0.3	16.5
D22-A	GAGE, CARBURETOR AIR TEMPERATURE	0513339-4	1.0	14.0
D25-S	CLOCK, ELECTRIC	C664508-0102	0.3	16.3
D25-O	CLOCK, DIGITAL READOUT	C664511-0101	0.3	16.3
D28-R	COMPASS, MAGNETIC-INSTALLATION	0513262-1	0.5	14.0
D38-R	INSTRUMENT CLUSTER, LH & RH FUEL QUANTITY	C669537-0106	0.4	16.5
D38-O	INSTRUMENT CLUSTER, LH & RH FUEL QUANTITY (USED WITH G82-O EXTENDED WING TANKS)	C669537-0101	0.4	16.5
D41-R	INSTRUMENT CLUSTER, OIL PRESSURE & TEMP.	** C669535-0101	0.5	16.5
D49-A	INDICATOR, ECONOMY MIXTURE (EGT)	0501043-2	0.6	7.8
D64-S	GYRO INSTALLATION, NON NAV-O-MATIC -DIRECTIONAL INDICATOR -ATTITUDE INDICATOR -HOSES & HARDWARE	0501054-1 C661075-0104 C661076-0101	6.3* 2.5 1.9 1.9	12.5* 13.5 13.5 10.2
D64-O	GYRO INSTALLATION FOR 300 NAV-O-MATIC -DIRECTIONAL INDICATOR -ATTITUDE INDICATOR -HOSES & HARDWARE	0501054-2 40760-0114 C661076-0101	6.4* 2.6 1.9 1.9	12.5* 13.5 13.5 10.1
D67-A	RECORDER INSTALLATION, FLIGHT HOUR	0501052-3	0.5	6.3
D82-S	GAGE, OUTSIDE AIR TEMPERATURE	C668507-0101	0.1	28.5

* C669535-0102 on airplanes modified by Service Kit SK172-81; C669564-0102 on airplanes modified by Service Kit SK172-82; 6247-00390 on airplanes modified by Service Kit SK172-123A.

SECTION 6
WEIGHT & BALANCE/
EQUIPMENT LIST

CESSNA
MODEL 172P

ITEM NO	EQUIPMENT LIST DESCRIPTION	REF DRAWING	WT LBS	ARM INS
D85-R	TACHOMETER INSTALLATION, ENGINE -RECORDING TACH. INDICATOR	0506007 C868020-0121	1.0 *	12.1 *
D88-S-1	INDICATOR, TURN COORDINATOR, 28 VOLT ONLY	C861003-0507	1.3	15.8
D88-S-2	INDICATOR, TURN COORDINATOR, 10-30 VOLT	C861003-0506	1.3	15.8
D88-O	INDICATOR, TURN COORDINATOR (USED W/ 200A & 300A N-O-M)	42320-0028	1.3	14.6
D91-S	INDICATOR, VERTICAL SPEED	C861080-0101	1.0	14.9
	E CABIN ACCOMMODATIONS			
E05-R	SEAT, ADJUSTABLE FORE & AFT PILOT	0514181	16.0	44.0
E05-O	SEAT, INFINITE ADJUSTABLE - PILOT	0514182	23.0	41.5
E07-S	SEAT, ADJUSTABLE FORE & AFT - CO-PILOT	0514181	16.0	44.0
E07-O	SEAT, INFINITE ADJUSTABLE - CO-PILOT	0514182	23.0	41.5
E09-S	SEAT, REAR (ONE PIECE BACK CUSHION)	0514183	23.0	79.5
E09-O	SEAT, REAR (TWO PIECE BACK CUSHION)	0514184	26.5	79.5
E15-R	PILOT LAP BELT ASSEMBLY	S-2275-103	1.0	37.0
E15-S	SHOULDER HARNESS ASSY - PILOT	S-2275-201	0.6	37.0
E19-O	SHOULDER HARNESS INERTIA REEL INSTL. PILOT & COPILOT. REPLACES STD. BELT'S AND SHOULDER HARNESS. (WT. NET CHANGE)	0501046-1	2.0	82.0
E23-S	BELT & SHOULDER ASSY - CO-PILOT	S-2275-3	1.6	37.0
E27-S	BELT ASSY, 2ND ROW (SET OF 2)	S-1746-39	2.0	70.0
E27-O	BELT & SHOULDER HARNESS ASSY	S-2275-8	3.2	70.0

ITEM NO	EQUIPMENT LIST DESCRIPTION	REF DRAWING	WT LBS	ARM INS
E34-0	(USES FOR 2ND ROW SEATING)	0515034	1.0	21.0
E35-A-1	DELUXE GLARESHIELD (NET CHANGE)	CES-1151	2.0	62.0
E35-A-2	LEATHER SEAT COVERING (NET CHG)	CES-1151	1.5	62.0
E37-0	LEATHER & VINYL OR FABRIC COVER (NET CHG)	0501075-1	2.3	47.0
E39-A	WINDOW, HINGED, RIGHT HAND DOOR (NET CHG)	0511800-10	0.9	47.9
E43-A	WINDOWS, OVERHEAD CABIN TOP (NET CHANGE)	0700322-14	1.7	60.0
E49-A	VENTILATION SYSTEM INSTL., REAR SEAT (NOT COMPATIBLE W/E88-A-1 & E88-A-2)	0501023-3	0.1	15.0
E50-A	BEVERAGE CUP HOLDER	1215073-11	1.5	47.0
E51-A	HEADREST, 1ST ROW (SET OF 2)	1215073-11	1.5	86.0
E55-S	HEADREST, 2ND ROW (SET OF 2)	0514166	0.9	32.8
E57-A	SUN VISOR INSTL., (SET OF 2)	0500267-2	NEGL	--
E59-A	CABIN WINDOWS, TINTED (NET CHANGE)	0415040-1	0.1	20.5
E65-S	APPROACH PLATE HOLDER INSTALLATION	2015009-8	0.5	95.0
E71-A	BAGGAGE NET	0500042	1.0	--
E75-A	RINGS, CARGO TIE DOWN (STOWED) (USE ARM AS INSTALLED W/CARGO)		9.8	--
E85-A	STRETCHER INSTALLATION, BOXED STOWED, NOT FACTORY INSTALLED	0513335-6	5.5	12.4
E87-A	CONTROL INSTALLATION, DUAL	0513290-1	1.9	9.4
E88-A-1	RUDDER TRIM SYSTEM INSTAL. CABIN AIR CONDITIONING SYSTEM, CHILLED AIR -AIR COMPRESSOR ASSY- AND CLUTCH -EVAPORATOR, (ABOVE AFT BAGGAGE)	0501066-1 C413001-0115	63.5* 20.2	43.2* -29.0 123.5

SECTION 6
WEIGHT & BALANCE/
EQUIPMENT LIST

CESSNA
MODEL 172P

ITEM NO	EQUIPMENT LIST DESCRIPTION	REF DRAWING	WT LBS	ARM INS
E88-A-2	-CONDENSER (UNDER SIDE FUSELAGE)		5.3	96.2
E89-O	CABIN AIR CIRCULATING FAN INSTAL. CONTROL WHEEL, ALL PURPOSE, PILOT (INCLUDED MIKE SW. & PANEL MOUNTED AUXILIARY MIKE JACK) (NET CHANGE)	0501072-2 0570087-1	10.0 NEGL	100.0 --
E93-R	HEATING SYSTEM, CABIN & CARBURETOR AIR -EXHAUST SYSTEM, INCLUDED NOTE--CARBURETOR HEAT IS REQUIRED CABIN HEAT IS STANDARD ITEM F. PLACARDS, WARNINGS & MANUALS	0550333-1 0506007	17.5	-21.0
F01-R	PLACARD, OPERATIONAL LIMITATIONS-DAY VFR	0505087	NEGL	--
F01-O-1	PLACARD, OPERATIONAL LIMITATIONS-DAY NIGHT VFR	0505087	NEGL	--
F01-O-2	PLACARD, OPERATIONAL LIMITATIONS-DAY NIGHT VFR & IFR	0505087	NEGL	--
F01-O-3	PLACARD, OPERATIONAL LIMITATIONS-DAY VFR FLOATPLANE	0505087	NEGL	--
F01-O-4	PLACARD, OPERATIONAL LIMITATIONS-DAY NIGHT VFR FLOATPLANE	0505087	NEGL	--
F01-O-5	PLACARD, OPERATIONAL LIMITATIONS-DAY NIGHT VFR & IFR FLOATPLANE	0505087	NEGL	--
F04-R	NOTE--THE ABOVE PLACARDS ARE INSTALLED ACCORDING TO AIRCRAFT EQUIPMENT			
F10-S	INDICATOR, AUDIBLE PNEUMATIC STALL WARNING PILOT'S CHECKLIST (STOWED)	0523112 D6083	0.2 0.3	28.5 15.0

ITEM NO	EQUIPMENT LIST DESCRIPTION	REF DRAWING	WT LBS	ARM INS
F13-S	(LOCATED AT GLOVE BOX) LOW VOLTAGE WARNING LIGHT, ALTERNATOR		NEGL	--
F16-R	PILOT'S OPERATING HANDBOOK & FAA APPROVED AIRPLANE FLIGHT MANUAL (AT BACK POCKET OF PILOT SEAT)	D1212-13PH	1.2	50.0
	G. AUXILIARY EQUIPMENT			
G07-A	RINGS, AIRPLANE HOISTING (CABIN TOP)	0541115-1	1.1	49.1
G13-A	CORROSION PROOFING, INTERNAL	0501108-1	10.0	77.0
G16-A	STATIC DISCHARGERS (SET OF 10)	0501048-1	0.4	143.2
G19-A	ABRASION BOOTS, STABILIZER	0500041-3	2.7	206.0
G22-A	TOW BAR, AIRPLANE (STOWED)	0501019-1	1.7	--
G25-S	PAINT, OVERALL EXTERIOR -OVERALL WHITE BASE -STRIPE COLOR SCHEME	0504043-2	12.6* 11.6 0.6	90.8* 90.5 96.9
G31-A	CABLES, CORROSION RESISTANT (NET CHG)	0500036	NEGL	--
G55-A	FIRE EXTINGUISHER INSTALLATION -FIRE EXTINGUISHER (GENERAL CORP) -FIRE EXTINGUISHER MOUNTING CLAMP	0501011-2 C421001-0201 C421001-0202	5.3* 4.8 0.5	42.8* 44.0 42.2
G58-A	STEPS & HANDLES, REFUELING ASSISTING	0513415-2	1.7	16.3
G67-A	RUDDER PEDAL EXTENSIONS, REMOVABLE (STOWABLE - INSTALLED ARM SHOWN) AVAILABLE FROM DEALERS, SET OF 2	0501082-1	2.3	8.0
G88-A-1	WINTERIZATION KIT INSTALLATION, ENGINE -BREATHER TUBE INSULATION -CONWL INLET COVERS (INSTL.)	0501008 0522011 0552132-5,-6	0.8* 0.4 0.3	22.7* 13.8 32.0

SECTION 6
WEIGHT & BALANCE/
EQUIPMENT LIST

CESSNA
MODEL 172P

ITEM NO	EQUIPMENT LIST DESCRIPTION	REF DRAWING	WT LBS	ARM INS
G88-A-2	-COWL INLET COVERS (STOWED) -OIL COOLER COVER PLATE WINTERIZATION KIT INSTALLATION -GREAT HER. TUBE INSULATION -COWL OUTLET COVER (INSTL.) -COWL OUTLET COVER (STOWED)	0552132-5,-6 0552220-1	0.3 0.1 1.0* 0.4 0.6 0.6	95.0 -10.2 -7.2* -12.0 95.0
G92-O-1	FUEL SYSTEM; (NET CHANGE) EXTENDED RANGE WING TANKS	0501055-2	8.0	48.0
G92-O-2	FUEL SYSTEM; (NET CHANGE) EXTENDED RANGE WET WINGS	0520018-7,-8	6.0	48.0
H01-A	H. AVIONICS & AUTOPILOTS CESSNA 300 ADF INSTALLATION, W/BFO -RECEIVER, R-346E -INDICATOR, IN-346A -SENSE ANT. INSTAL. -LOOP ANT. INSTAL. -WIRING & HARDWARE	3910159-2 41240-001 40980-1001 0570400-632 3940104-1 3950122-31	6.9* 3.3 0.9 0.2 1.4 1.1	23.2* 13.1 14.1 101.8 58.2 20.8
H04-A	COLLINS DME-451 INSTALLATION -INDICATOR, IND-450C -TRANSMITTER, TCR-451 -ANTENNA, ANT-451 -WIRING & MISC. ITEMS	3910213-1 622-3588-001 622-3670-001 622-4011-001	7.6* 0.9 5.3 0.2 1.2	94.0* 14.5 118.0 86.3 47.2
H05-A	COLLINS ANS-351C R-NAV INSTALLATION -INDICATOR, IN-442AR ADDED -INDICATOR, IN-385A DELETED -COMPUTER, R-NAV, ANS-351C -COOLING, WIRING & HARDWARE	3910214-1 43910-1000 42860-1000 622-5579-001	3.9* 1.0 -1.6 3.3 1.1	23.9* 14.7 14.5 47.8
H07-A	CESSNA 400 GLIDESLOPE (INCLUDES VOR/ILS INDICATOR - NET CHANGE FOR VOR/LOC IND.) -400 GLIDESLOPE RECEIVER, R-443B -ANTENNA COUPLER, (NET CHANGE)	3910157-2 42100-0000 52473-1	4.7* 2.1 NEGL	80.4* 117.2 --

ITEM NO	EQUIPMENT LIST DESCRIPTION	REF DRAWING	WT LBS	ARM INS
H08-A-1	-VOR/ILS INDICATOR, ADDED IN-386A -VOR/LOC INDICATOR, IN-385A DELETED -WIRING, MOUNTING & MISC. HARDWARE AUTO RADIAL CENTERING INDICATOR (ARC/LOC) EXCHANGE FOR VOR/LOC IND (300 SERIES) NAV- COM 720 CH COM 1ST & 2ND UNIT (WT NET CHG) -ARC/LOC INDICATOR, IN-385AC -VOR/LOC INDICATOR, IN-385A DELETED	46860-2000 46860-1000 3950122 3910196-1	1.7 -1.6 2.5 0.2*	14.7 14.6 53.1 14.7*
H08-A-2	AUTO RADIAL CENTERING INDICATOR (ARC/ILS) EXCHANGE FOR VOR/ILS INDICATOR USED WITH ITEM H07-A 400 GLIDEPLOPE (WT NET CHANGE) -ARC/ILS INDICATOR, IN-386A C ADDED -VOR/ILS INDICATOR, IN-386A DELETED	46860-2200 46860-2000	1.8 -1.6	14.7 14.7
H11-A	SUNAIR ASB-125 HF TRANSCEIVER, 2ND UNIT -ANTENNA LOAD BOX, CU-1000A -POWER SUPPLY & SHOCK RACK -TRANSCIVER, PANEL MOUNTED -ANTENNA INSTALL. 351, IN LONG -WIRING AND MISC. HARDWARE	3910158-1 99816 99681 99681 3960117-3 3950122-12	20.4* 8.9 8.5 5.3 0.3 1.4	86.7* 113.5 113.0 13.4 174.4 92.3
H13-A	CESSNA 400 MARKER BEACON INSTALLATION -RECEIVER, R-402A -ANTENNA, L. ROD -MARKER BEACON KIT -WIRING & HARDWARE	3910164-19 42410-5128 0770881-1 0770017-3 3950122	2.4* 0.7 0.7 0.1 0.9	57.4* 12.1 140.0 16.6 33.0
H16-A-1	CESSNA 300 TRANSPONDER INSTALLATION -TRANSCIVER, RT-359A -TRANSPONDER, ANTENNA -WIRING AND HARDWARE	3910127-17 41420-0028 42940-0000 3950122	4.0* 2.7 0.2 1.1	26.4* 14.2 127.0 38.7
H16-A-2	CESSNA 400 TRANSPONDER (USED FOR EXPORT) -TRANSCIVER, RT-459A -TRANSPONDER, ANTENNA -WIRING AND HARDWARE	3910128-21 41470-1028 42940-0000 3950122	4.1* 2.8 0.2 1.1	26.4* 14.2 127.0 38.7
H22-A	CESSNA 300 NAV/COM 720 CH COM INSTALLATION REQUIRES H37-A TO BE OPERATIONAL 1ST UNIT H37-A TO BE OPERATIONAL 2ND UNIT	3910183-4	7.7*	13.3*

SECTION 6
WEIGHT & BALANCE/
EQUIPMENT LIST

CESSNA
MODEL 172P

ITEM NO	EQUIPMENT LIST DESCRIPTION	REF DRAWING	WT LBS	ARM INS
	-RECEIVER-TRANSCIVER, RT-385A -VOR/LOC INDICATOR, IN-585A -MOUNT, WIRING & MISC. HARDWARE	46660-1000 48800-1000 3950122-26	5.5 1.6 0.6	13.5 14.5 12.5
H28-A-1	EMERGENCY LOCATOR TRANSMITTER -TRANSMITTER (D & M DMELT-6-1) -ANTENNA -HARDWARE	0470419-3 C589511-0117 C589511-0109	3.5* 3.3 0.1	116.5* 116.4 122.0 114.3
H28-A-2	EMERGENCY LOCATOR TRANSMITTER (USED IN CANADA) -TRANSMITTER (D & M DMELT-6-1C) -ANTENNA -HARDWARE	0470419-4 C589511-0113 C589511-0109	3.5* 3.3 0.1	116.5* 116.4 114.3
H31-A-1	NAV-O-MATIC 200A INSTALLATION (AF-295A) -CONTROLLER-AMPLIFIER, CA-295B -TURN COORDINATOR (NET CHANGE) -AILERON ROLL ACTUATOR PA-495A -A/P RELAY INSTALLATION KIT -WIRING AND MISC. HARDWARE	3910162-1 43610-1202 42320-0028 42730-3908 2470016-4 3950117-7	8.1* 1.1 NEG 3.8 0.4 2.8	47.3* 13.5 - 61.1 4.0 48.2
H31-A-2	NAV-O-MATIC 200A INSTALLATION (AF-395A) -CONTROLLER-AMPLIFIER, CA-395A -D64-0 GYRO INSTL. (NET CHANGE) -D88-0 TURN COORD. (NET CHANGE) -AILERON ROLL ACTUATOR, PA-439A -A/P RELAY INSTALLATION KIT -WIRING AND MISC. HARDWARE	3910163-1 42660-1202 0501034-2 42320-0028 42730-3908 2470016-4 3950115-7	8.5* 1.4 0.1 NEG 3.8 0.4 2.8	45.4* 13.5 12.5 - 61.1 4.0 51.2
H33-A	INTERCOM SYSTEM INSTALLATION REQUIRES--E85-0 ALL PURPOSE CONTROL WHEEL E85-A DUAL CONTROL WHEEL INSTL. -JACK INSTL. FOR INTERPHONE (R.H.) -H85-A HEADPHONE & MIKE (SET OF 2) -INTERCOM, P/C BOARD ASSEMBLY -R.H. CONTROL WHEEL INSTALLATION	3910210-3 3970150-2 C596531-0101 3970149-1 3970153-3	2.9* 0.3 0.2 0.5	15.0* 18.0 13.0 12.0 19.0
H34-A	BASIC AVIONICS KIT INSTALLATION REQUIRES 1ST NAV/COM TO OPERATE -BLOWER & COOLING INSTALLATION -NOISE FILTER-AUDIO (ON ALT.)	3910186-2 3930214 3940148-2	7.2* 1.6 0.1	42.7* 10.2 -26.1

ITEM NO	EQUIPMENT LIST DESCRIPTION	REF DRAWING	WT LBS	ARM INS
H37-A	<ul style="list-style-type: none"> -L.H. COM ANTENNA CABLE INSTL. -NAV ANTENNA CABLE INSTALLATION -COM ANTENNA CABLE INSTL. ANT. -COM ANTENNA CABLE INSTL. ANT. -COM VHF COM ANTENNA INSTALLATION -CABIN SPEAKER INSTALL. & WIRING -MICROPHONE & MIC JACK HANDHELD -HEADPHONE & JACK INSTALLATION -AUDIO CONTROL PANEL INSTALLATION -1ST N/C TRANSCIEVER KIT INSTL. 	<ul style="list-style-type: none"> 3950122-36 3950122-4 3960122-1 3960123-1 3970123-5 3970124-1 3970124-4 3970125-1 3930186-2 	<ul style="list-style-type: none"> 0.4 0.9 0.3 0.4 1.2 0.3 0.2 1.8 0.1 	<ul style="list-style-type: none"> 27.8 120.8 220.4 222.9 37.2 17.2 14.2 11.5 16.5
H37-A	ANTENNA & COUPLER KIT INSTALLATION REQUIRED W/2ND NAV/COM, CONSISTS OF--	3910185-2	1.1*	36.1*
H43-A	2ND N/C TRANSCIEVER KIT INSTL.	3930186-4	0.1	16.5
H55-A	COM ANTENNA CABLE INSTL. R.H.	3950122-5	0.4	27.8
H56-A	300 NAV/COM ANT. COUPLER, INSTL.	3960111-9	0.2	10.0
	VHF ANTENNA INSTALLATION, R.H.	3960113-2	0.4	62.4
	AVIONICS OPTION D NAV-O-MATIC WING PROV.	0522632-2	1.7	68.2
	MIKE - HEADSET (STOWED) COMBINATION (REQUIRES E89-O ALL PURPOSE CONTROL)	C596533-0101	0.3	13.0
	MICROPHONE & HEADSET PADDED (STOWED) (REQUIRES E89-O ALL PURPOSE CONTROL)	C596531-0101	1.1	13.0
J01-A	<p>J. SPECIAL OPTION PACKAGES</p> <p>SKYHAWK II EQUIPMENT CONSISTS OF ITEMS</p> <ul style="list-style-type: none"> -C16-O HEATED PITOT SYSTEM INSTL. -C31-A COURTESY LIGHTS INSTL. (2) -C40-A NAV LIGHT DETECTOR INSTL. -C43-A LIGHT INSTL. FLASH BEACON -D01-O AIRSPED IND. (LINE T CHG.) -D04-A STALIC ALTERNATE SOURCE -E85-A DUAL CONTROL INSTALLATION -F26-A NAV/COM IN-385A 1ST UNIT -F26-A-1 EMERGENCY LOC TRANSMITTER -H34-A BASIC AVIONICS KIT INSTL. 	<ul style="list-style-type: none"> 0500510 0422355-8 0521101-1 0701123-1 0509903-2 0513279-2 0510107-1 0513335-6 3910183-4 0470419-3 3910186-2 	<ul style="list-style-type: none"> 26.7* 0.6 0.5 NEGL. 6.7 0.1 0.2 5.7 3.5 	<ul style="list-style-type: none"> 45.7* 24.4 61.0 204.7 18.3 15.4 12.3 116.5 142.7

SECTION 6
WEIGHT & BALANCE/
EQUIPMENT LIST

CESSNA
MODEL 172P

ITEM NO	EQUIPMENT LIST DESCRIPTION	REF DRAWING	WT LBS	ARM INS
J04-A	NAV-PAC INSTALLATION (SKYHAWK II ONLY) -H01-A 300 ADE INSTL R-546E -H16-A-1 300 TRANSDUCER RT-359A -H22-A NAV/COM ZND UNIT IN-385A -H37-A ANT. & COUPLER KIT INSTL	3910159-2 3910127-17 3910183-4 3910185-2	19.8* 6.9 4.0 7.7 1.1	20.8* 23.2 28.4 13.3 36.1
J10-A	FLOATPLANE FUSELAGE STRUCTURAL MODIFICATIONS & FITTING, OPT C	0500044	6.6	43.7
J13-A	FLOATPLANE COWLDECK V-BRACE -INSTALLED -STOWED	0513529-1	1.1 1.1	26.2 95.0
J15-A	FLOATPLANE AILERON-RUDDER INTERCONNECT -INSTALLED	0560012	0.4	69.6
J27-A	NOTE--J10-A & J13-A ARE ALSO APPROVED FOR THE LANDPLANE OPERATIONS. MODEL 89 A2000 FLOATS & 502 ATTACHMENTS NET CHG BETWEEN STANDARD LANDING GEAR (ITEM NOS. B04-R, B04-BIO-S, BRAKE & NOSE WHEEL STEERING SYST.) & FLOATPLANE KIT (ITEM NO. J30-A-1) IS APPROXIMATELY 155 LBS. AT 58.3 IN. FOR WT & ARM CALCULATIONS ARE TO BE DETERMINED FROM THE ACTUAL INSTALLATION WEIGHING	EDD-36335	--	--
J30-A-1	FLOATPLANE EQUIPMENT KIT W/PROP CHANGE & CORROSION PROOFING CONSISTS OF THE ITEMS -J03-0 PROPELLER, FLOATPLANE OPERATION -J01-0 PLACES, CORROSION RESIST EXCH -J03-A CORROSION PROOFING, INTERNAL -J07-A AIRPLANE (CABIN TOP) -J08-A STEPS AND HANDICAP REFUELING -J10-A FUSELAGE MODIFICATION, INSTALLED -J13-A COWLDECK V-BRACE, INSTALLED -J15-A INTERCONNECT SYST, INSTALLED - COWL ASSY., FLOATPLANE, EXCH	0501080-1 050220-6 0505087 0500036-5 0500036 0541115-1 0513415-2 0500044-44 0513529-1 0560012-1 0562162-7	23.8* 2.9 0.0 0.0 10.0 1.1 1.7 1.6 1.1 1.4 NEGL	45.7* -38.3 -- -- 77.0 49.1 16.3 43.7 26.2 6.6 --

ITEM NO	EQUIPMENT LIST DESCRIPTION	REF DRAWING	WT LBS	ARM INS
J30-A-2	FLOATPLANE EQUIPMENT KIT W/CORROSION PROOFING V-BRACE, INSTALLED AND NO PROP CHANGE -F01-U -G01-A -G03-A -G07-A -G58-A -J10-A -J13-A -G15-A	0501080-2 0505087 0500036-5 0541115-1 0513415-2 0500044-4 0513529-1 0560012-1	20.9* NEGL NEGL 10.0 1.7 1.7 6.6 1.1 0.4	57.9* -- -- 77.0 49.1 16.3 43.7 26.2 95.0
J30-A-3	FLOATPLANE EQUIPMENT KIT W/PROP CHANGE AND NO CORROSION PROOFING CONSISTS OF ITEMS -- -A33-U -F01-U -G01-A -G07-A -G58-A -J10-A -J13-A -J15-A	0501080-3 0550320-6 0505087 0541115-1 0513415-2 0500044-4 0513529-1 0560012-1 0552162-7	13.8* 2.9 NEGL 1.7 1.7 6.6 1.1 0.4	23.1* -38.3 -- 49.1 16.3 43.7 26.2 69.6
J30-A-4	FLOATPLANE EQUIPMENT KIT W/NO PROP CHANGE OR CORROSION PROOFING CONSISTS OF ITEMS -- USE PRIMARILY IN CANADA ONLY -G07-A -G58-A -J10-A -J13-A -J15-A	0501080-4 0541115-1 0513415-2 0500044-4 0513529-1 0560012-1	10.9* 1.7 1.7 6.6 1.1 0.4	40.3* 49.1 16.3 43.7 26.2 95.0

Notes: _____

SECTION 7 AIRPLANE & SYSTEMS DESCRIPTIONS

TABLE OF CONTENTS

	Page
Introduction	7-3
Airframe	7-3
Flight Controls	7-8
Trim System	7-8
Instrument Panel	7-9
Ground Control	7-10
Wing Flap System	7-10
Landing Gear System	7-11
Baggage Compartment	7-11
Seats	7-12
Seat Belts And Shoulder Harnesses	7-12
Seat Belts	7-12
Shoulder Harnesses	7-14
Integrated Seat Belt/Shoulder Harnesses With Inertia Reels	7-15
Entrance Doors And Cabin Windows	7-16
Control Locks	7-16
Engine	7-16
Engine Controls	7-17
Engine Instruments	7-18
New Engine Break-In And Operation	7-18
Engine Oil System	7-19
Ignition-Starter System	7-19
Air Induction System	7-19
Exhaust System	7-19
Carburetor And Priming System	7-20
Cooling System	7-20
Propeller	7-20
Fuel System	7-23
Brake System	7-24
Electrical System	7-24
Master Switch	7-24
Avionics Power Switch	7-26

TABLE OF CONTENTS (Continued)

	Page
Ammeter	7-26
Alternator Control Unit And Low-Voltage Warning Light	7-26
Circuit Breakers And Fuses	7-27
Ground Service Plug Receptacle	7-28
Lighting Systems	7-28
Exterior Lighting	7-28
Interior Lighting	7-28
Cabin Heating, Ventilating And Defrosting System	7-30
Pitot-Static System And Instruments	7-30
Airspeed Indicator	7-32
Vertical Speed Indicator	7-33
Altimeter	7-33
Vacuum System And Instruments	7-33
Attitude Indicator	7-33
Directional Indicator	7-33
Suction Gage	7-35
Stall Warning System	7-35
Avionics Support Equipment	7-35
Avionics Cooling Fan	7-35
Microphone - Headset Installations	7-36
Static Dischargers	7-36

INTRODUCTION

This section provides description and operation of the airplane and its systems. Some equipment described herein is optional and may not be installed in the airplane. Refer to Section 9, Supplements, for details of other optional systems and equipment.

AIRFRAME

The airplane is an all-metal, four-place, high-wing, single-engine airplane equipped with tricycle landing gear and designed for general utility purposes.

The construction of the fuselage is a conventional formed sheet metal bulkhead, stringer, and skin design referred to as semimonocoque. Major items of structure are the front and rear carry-through spars to which the wings are attached, a bulkhead and forgings for main landing gear attachment at the base of the rear door posts, and a bulkhead with attach fittings at the base of the forward door posts for the lower attachment of the wing struts. Four engine mount stringers are also attached to the forward door posts and extend forward to the firewall.

The externally braced wings, containing the fuel tanks, are constructed of a front and rear spar with formed sheet metal ribs, doublers, and stringers. The entire structure is covered with aluminum skin. The front spars are equipped with wing-to-fuselage and wing-to-strut attach fittings. The aft spars are equipped with wing-to-fuselage attach fittings, and are partial-span spars. Conventional hinged ailerons and single-slot type flaps are attached to the trailing edge of the wings. The ailerons are constructed of a forward spar containing balance weights, formed sheet metal ribs and "V" type corrugated aluminum skin joined together at the trailing edge. The flaps are constructed basically the same as the ailerons, with the exception of the balance weights and the addition of a formed sheet metal leading edge section.

The empennage (tail assembly) consists of a conventional vertical stabilizer, rudder, horizontal stabilizer, and elevator. The vertical stabilizer consists of a spar, formed sheet metal ribs and reinforcements, a wrap-around skin panel, formed leading edge skin and a dorsal. The rudder is constructed of a formed leading edge skin containing hinge halves, a center wrap-around skin panel, ribs, an aft wrap-around skin panel which is joined at the trailing edge of the rudder by a filler strip, and a ground adjustable trim tab at the base of the trailing edge. The top of the rudder incorporates a leading edge extension which contains a balance weight.

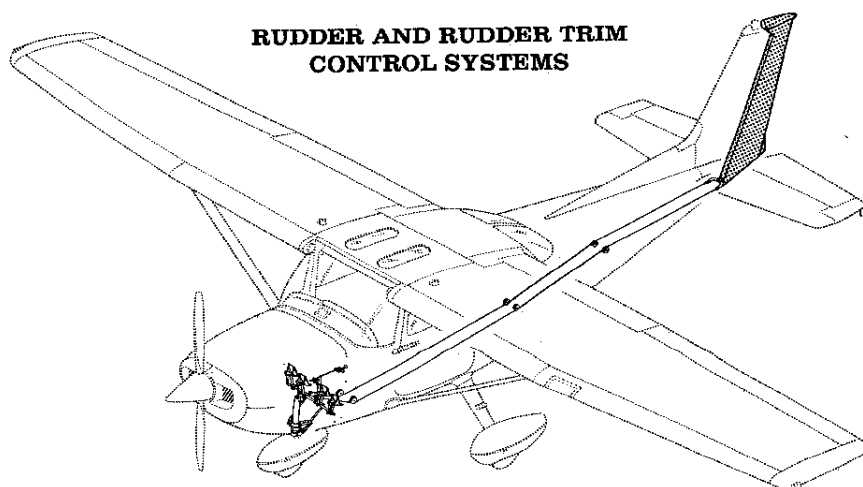
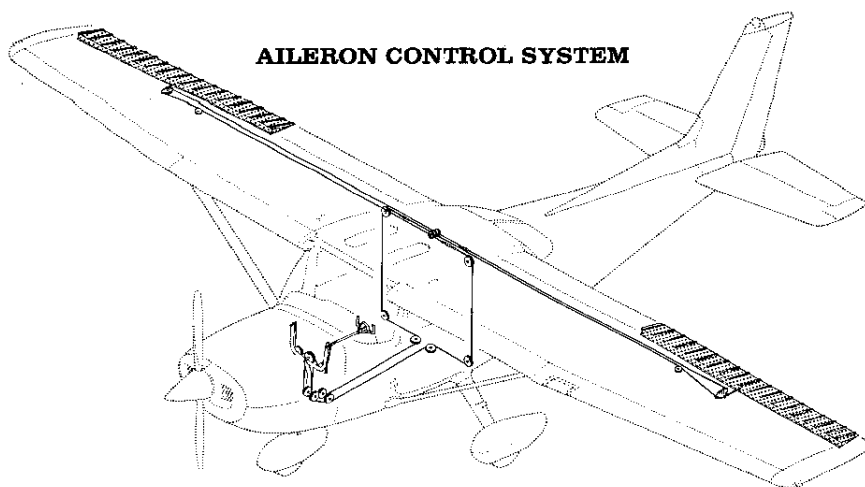
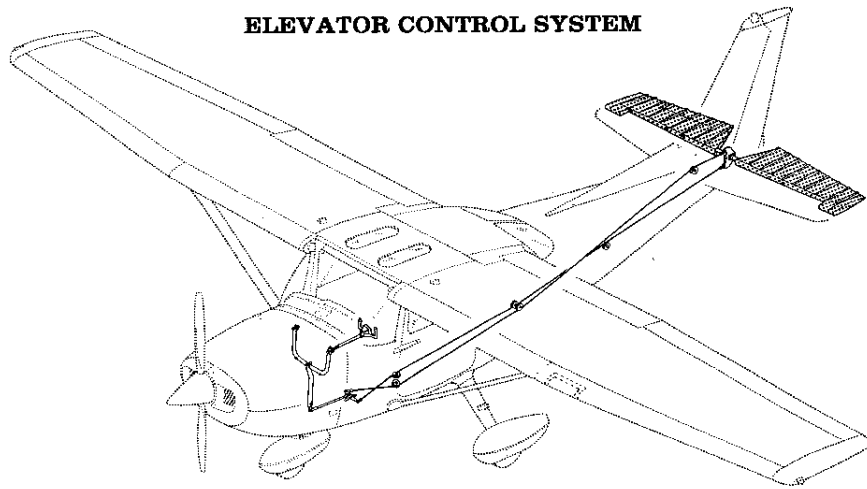

Figure 7-1. Flight Control and Trim Systems (Sheet 1 of 2)

ELEVATOR CONTROL SYSTEM



ELEVATOR TRIM CONTROL SYSTEM

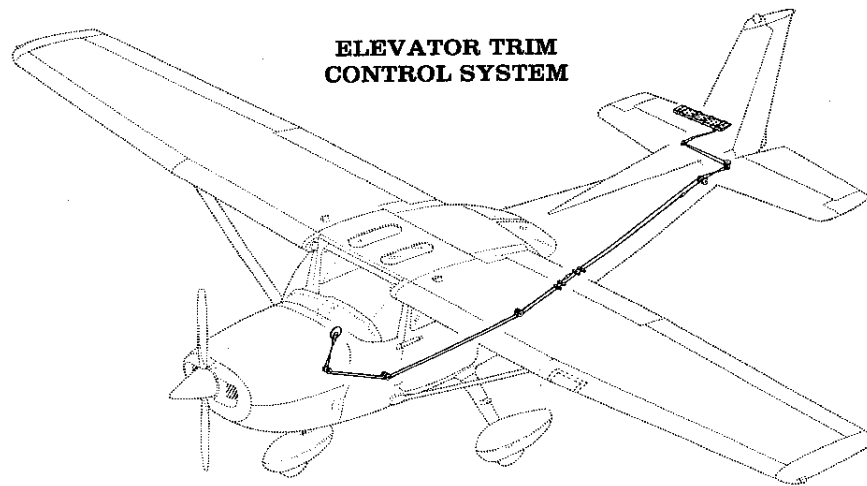

Figure 7-1. Flight Control and Trim Systems (Sheet 2 of 2)

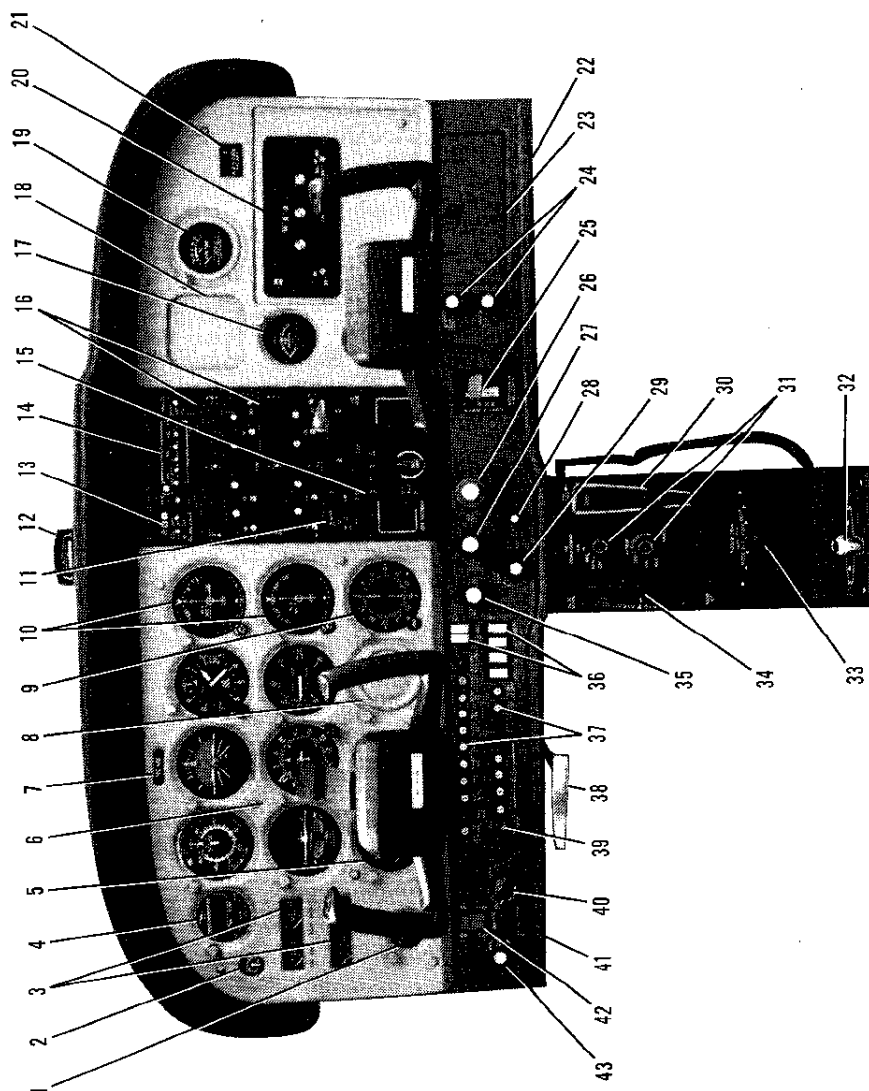

Figure 7-2. Instrument Panel (Sheet 1 of 2)

- | | | | |
|-----|---|-----|--|
| 1. | Ammeter | 23. | Map Compartment |
| 2. | Suction Gage | 24. | Cabin Heat and Air Control Knobs |
| 3. | Oil Temperature, Oil Pressure, and Fuel Quantity Indicators | 25. | Wing Flap Switch and Position Indicator |
| 4. | Digital Clock | 26. | Mixture Control |
| 5. | Tachometer | 27. | Throttle (With Friction Lock) |
| 6. | Flight Instrument Group | 28. | Static Pressure Alternate Source Valve |
| 7. | Airplane Registration Number | 29. | Instrument and Radio Light Dimming Rheostats |
| 8. | Additional Instrument Space | 30. | Handheld Microphone |
| 9. | ADF Bearing Indicator | 31. | Air Conditioning Controls |
| 10. | Course Deviation Indicators | 32. | Fuel Selector Valve Handle |
| 11. | Transponder | 33. | Rudder Trim Control Lever |
| 12. | Magnetic Compass | 34. | Elevator Trim Control Wheel and Position Indicator |
| 13. | Marker Beacon Indicator Lights and Switches | 35. | Carburetor Heat Control |
| 14. | Audio Control Panel | 36. | Electrical Switches |
| 15. | Autopilot Control Unit | 37. | Circuit Breakers |
| 16. | Nav/Com Radios | 38. | Parking Brake Handle |
| 17. | Economy Mixture Indicator (EGT) | 39. | Avionics Power Switch |
| 18. | Additional Instrument Space | 40. | Ignition Switch |
| 19. | Carburetor Air Temperature Gage | 41. | Auxiliary Phone and Mike Jacks (Pilot) |
| 20. | ADF Radio | 42. | Master Switch |
| 21. | Flight Hour Recorder | 43. | Primer |
| 22. | Auxiliary Phone and Mike Jacks (Front Passenger) | | |

Figure 7-2. Instrument Panel (Sheet 2 of 2)

The horizontal stabilizer is constructed of a forward and aft spar, ribs and stiffeners, center, left, and right wrap-around skin panels, and formed leading edge skins. The horizontal stabilizer also contains the elevator trim tab actuator. Construction of the elevator consists of formed leading edge skins, a forward spar, aft channel, ribs, torque tube and bellcrank, left upper and lower "V" type corrugated skins, and right upper and lower "V" type corrugated skins incorporating a trailing edge cut-out for the trim tab. The elevator trim tab consists of a spar, rib, and upper and lower "V" type corrugated skins. The leading edge of both left and right elevator tips incorporate extensions which contain balance weights.

FLIGHT CONTROLS

The airplane's flight control system (see figure 7-1) consists of conventional aileron, rudder, and elevator control surfaces. The control surfaces are manually operated through mechanical linkage using a control wheel for the ailerons and elevator, and rudder/brake pedals for the rudder.

Extensions are available for the rudder/brake pedals. They consist of a rudder pedal face, two spacers and two spring clips. To install an extension, place the clip on the bottom of the extension under the bottom of the rudder pedal and snap the top clip over the top of the rudder pedal. Check that the extension is firmly in place. To remove the extensions, reverse the above procedures.

TRIM SYSTEM

A manually-operated elevator trim system is provided; a rudder trim system may also be installed (see figure 7-1). Elevator trimming is accomplished through the elevator trim tab by utilizing the vertically mounted trim control wheel. Forward rotation of the trim wheel will trim nose-down; conversely, aft rotation will trim nose-up. Rudder trimming is accomplished through a bungee connected to the rudder control system and a trim lever, mounted on the control pedestal. Rudder trimming is accomplished by lifting the trim lever up to clear a detent, then moving it either left or right to the desired trim position. Moving the trim lever to the right will trim the airplane nose-right; conversely, moving the lever to the left will trim the airplane nose-left.

INSTRUMENT PANEL

The instrument panel (see figure 7-2) is designed around the basic "T" configuration. The gyros are located immediately in front of the pilot, and arranged vertically over the control column. The airspeed indicator and

altimeter are located to the left and right of the gyros, respectively. The remainder of the flight instruments are located around the basic "T". Engine instruments, fuel quantity indicators, an ammeter, and a low-voltage warning light are near the left edge of the panel. Avionics equipment is stacked approximately on the centerline of the panel, with the right side of the panel containing space for additional instruments and avionics equipment. A switch and control panel at the lower edge of the instrument panel contains the primer, master and ignition switches, avionics power switch, circuit breakers, and electrical switches on the left side, with the engine controls, light intensity controls, and static pressure alternate source valve in the center. The right side of the switch and control panel contains the wing flap switch lever and position indicator, cabin heat and air controls, and map compartment. A control pedestal, installed below the switch and control panel, contains the elevator trim control wheel and position indicator, and provides a bracket for the microphone. A rudder trim control lever may be installed below the trim wheel and microphone bracket. The fuel selector valve handle is located at the base of the pedestal. A parking brake handle is mounted below the switch and control panel in front of the pilot.

For details concerning the instruments, switches, circuit breakers, and controls on this panel, refer in this section to the description of the systems to which these items are related.

GROUND CONTROL

Effective ground control while taxiing is accomplished through nose wheel steering by using the rudder pedals; left rudder pedal to steer left and right rudder pedal to steer right. When a rudder pedal is depressed, a spring-loaded steering bungee (which is connected to the nose gear and to the rudder bars) will turn the nose wheel through an arc of approximately 10° each side of center. By applying either left or right brake, the degree of turn may be increased up to 30° each side of center.

Moving the airplane by hand is most easily accomplished by attaching a tow bar to the nose gear strut. If a tow bar is not available, or pushing is required, use the wing struts as push points. Do not use the vertical or horizontal surfaces to move the airplane. If the airplane is to be towed by vehicle, never turn the nose wheel more than 30° either side of center or structural damage to the nose gear could result.

The minimum turning radius of the airplane, using differential braking and nose wheel steering during taxi, is approximately 27 feet 5 and 1/2 inches. To obtain a minimum radius turn during ground handling, the airplane may be rotated around either main landing gear by pressing down on a tailcone bulkhead just forward of the horizontal stabilizer to raise the nose wheel off the ground.

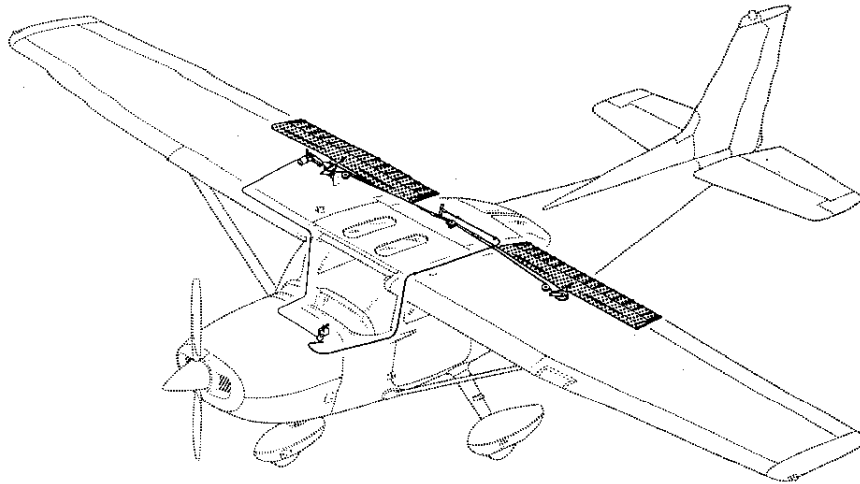

Figure 7-3. Wing Flap System

WING FLAP SYSTEM

The single-slot type wing flaps (see figure 7-3), are extended or retracted by positioning the wing flap switch lever on the instrument panel to the desired flap deflection position. The switch lever is moved up or down in a slotted panel that provides mechanical stops at the 10° and 20° positions. For flap settings greater than 10°, move the switch lever to the right to clear the stop and position it as desired. A scale and pointer on the left side of the switch lever indicates flap travel in degrees. The wing flap system circuit is protected by a 10-ampere circuit breaker, labeled FLAP, on the left side of the switch and control panel.

LANDING GEAR SYSTEM

The landing gear is of the tricycle type with a steerable nose wheel, two main wheels, and wheel fairings. Shock absorption is provided by the tubular spring-steel main landing gear struts and the air/oil nose gear shock strut. Each main gear wheel is equipped with a hydraulically actuated single-disc brake on the inboard side of each wheel, and an aerodynamic fairing over each brake.

BAGGAGE COMPARTMENT

The baggage compartment consists of two areas, one extending from behind the rear passengers' seat to the aft cabin bulkhead, and an additional area aft of the bulkhead. Access to both baggage areas is gained through a lockable baggage door on the left side of the airplane, or from within the airplane cabin. A baggage net with eight tie-down straps is provided for securing baggage and is attached by tying the straps to tie-down rings provided in the airplane. When loading the airplane, children should not be placed or permitted in the baggage compartment, unless a child's seat is installed, and any material that might be hazardous to the airplane or occupants should not be placed anywhere in the airplane. For baggage area and door dimensions, refer to Section 6.

SEATS

The seating arrangement consists of two individually adjustable four-way or six-way seats for the pilot and front seat passenger and a solid back or split-backed fixed seat for rear seat passengers. A child's seat (if installed) is located at the aft cabin bulkhead behind the rear seat.

The four-way seats may be moved forward or aft, and the angle of the seat backs is infinitely adjustable. To position the seat, lift the tubular handle below the center of the seat frame, slide the seat into position, release the handle and check that the seat is locked in place. The seat back angle is controlled by a cylinder lock release button which is spring-loaded to the locked position. The release button is located on the right side, below the forward corner of the seat cushion. To adjust the angle of the seat back, push up on the release button, position the seat back to the desired angle and release the button. When the seat is not occupied, the seat back will automatically fold forward whenever the release button is pushed up.

The six-way seats may be moved forward or aft, and are infinitely adjustable for height and seat back angle. To position either seat, lift the tubular handle under the center of the seat bottom, slide the seat into position, release the handle, and check that the seat is locked in place. Raise or lower the seat by rotating the large crank under the inboard corner of either seat. The seat back angle is adjusted by rotating the small crank under the outboard corner of either seat. The seat bottom angle will change as the seat back angle changes, providing proper support. The seat back will also fold full forward.

The rear passengers' seat consists of a fixed one-piece seat bottom with either one-piece (adjustable to the vertical position or either of two reclining positions) or two-piece (individually, infinitely adjustable) seat backs. The one-piece back is adjusted by a lever located below the center of

the seat frame. Two-piece seat backs are adjusted by cylinder lock release buttons recessed into skirts located below the seat frame at the outboard ends of the seat. To adjust the one-piece seat back, raise the lever, position the seat back to the desired angle, release the lever and check that the back is locked in place. To adjust a two-piece seat back, push up on the cylinder lock release button (which is spring-loaded to the locked position), recline the seat back to the desired position, and release the button. When the seats are not occupied, either type of seat back will automatically fold forward whenever the lever is raised or the cylinder lock release button is pushed up.

A child's seat may be installed behind the rear passengers' seat in the forward baggage compartment, and is held in place by two brackets mounted on the floorboard. When not occupied, the seat may be stowed by rotating the seat bottom up and aft until it contacts the aft cabin bulkhead.

Headrests are available for any of the seat configurations except the child's seat. To adjust the headrest, apply enough pressure to it to raise or lower it to the desired level. The headrest may be removed at any time by raising it until it disengages from the top of the seat back.

SEAT BELTS AND SHOULDER HARNESSSES

All seat positions are equipped with seat belts (see figure 7-4). The pilot's and front passenger's seats are also equipped with separate shoulder harnesses; separate shoulder harnesses are available for the rear seat positions and can be readily installed to attach points furnished in the airplane. Integrated seat belt/shoulder harnesses with inertia reels can be furnished for the pilot's and front passenger's seat positions if desired.

SEAT BELTS

All of the seat belts are attached to fittings on the floorboard. The buckle half is inboard of each seat and the link half is outboard of each seat.

To use the seat belts for the front seats, position the seat as desired, and then lengthen the link half of the belt as needed by grasping the sides of the link and pulling against the belt. Insert and lock the belt link into the buckle. Tighten the belt to a snug fit. Seat belts for the rear seat and the child's seat (if installed) are used in the same manner as the belts for the front seats. To release the seat belts, grasp the top of the buckle opposite the link and pull outward.

SHOULDER HARNESSSES

Each front seat shoulder harness (see figure 7-4) is attached to a rear

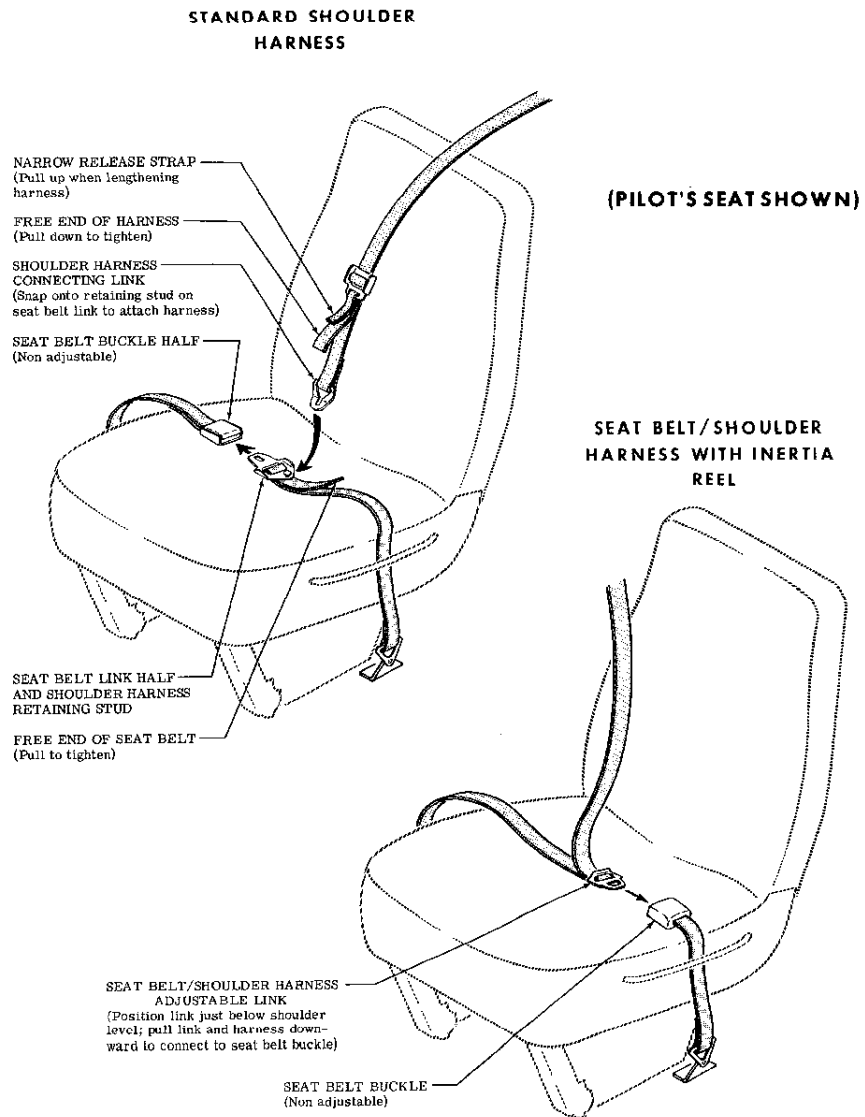

Figure 7-4. Seat Belts and Shoulder Harnesses

doorpost above the window line and is stowed behind a stowage sheath above the cabin door. To stow the harness, fold it and place it behind the sheath. The rear seat shoulder harnesses are attached adjacent to the lower corners of the rear window. Each rear seat harness is stowed behind a stowage sheath above an aft side window. No harness is available for the child's seat.

To use a front or rear seat shoulder harness fasten and adjust the seat belt first. Lengthen the harness as required by pulling on the connecting link on the end of the harness and the narrow release strap. Snap the connecting link firmly onto the retaining stud on the seat belt link half. Then adjust to length. A properly adjusted harness will permit the occupant to lean forward enough to sit completely erect, but prevent excessive forward movement and contact with objects during sudden deceleration. Also, the pilot will want the freedom to reach all controls easily.

Removing the shoulder harness is accomplished by pulling upward on the narrow release strap, and removing the harness connecting link from the stud on the seat belt link. In an emergency, the shoulder harness may be removed by releasing the seat belt first, and allowing the harness, still attached to the link half of the seat belt, to drop to the side of the seat.

INTEGRATED SEAT BELT/SHOULDER HARNESSSES WITH INERTIA REELS

Integrated seat belt/shoulder harnesses with inertia reels are available for the pilot and front seat passenger. The seat belt/shoulder harnesses extend from inertia reels located in the cabin ceiling to attach points inboard of the two front seats. A separate seat belt half and buckle is located outboard of the seats. Inertia reels allow complete freedom of body movement. However, in the event of a sudden deceleration, they will lock automatically to protect the occupants.

NOTE

The inertia reels are located for maximum shoulder harness comfort and safe retention of the seat occupants. This location requires that the shoulder harnesses cross near the top so that the right hand inertia reel serves the pilot and the left hand reel serves the front passenger. When fastening the harness, check to ensure the proper harness is being used.

To use the seat belt/shoulder harness, position the adjustable metal link on the harness just below shoulder level, pull the link and harness downward, and insert the link into the seat belt buckle. Adjust belt tension

across the lap by pulling upward on the shoulder harness. Removal is accomplished by releasing the seat belt buckle, which will allow the inertia reel to pull the harness inboard of the seat.

ENTRANCE DOORS AND CABIN WINDOWS

Entry to, and exit from the airplane is accomplished through either of two entry doors, one on each side of the cabin at the front seat positions (refer to Section 6 for cabin and cabin door dimensions). The doors incorporate a recessed exterior door handle, a conventional interior door handle, a key-operated door lock (left door only), a door stop mechanism, and an openable window in the left door. An openable right door window is also available.

NOTE

The door latch design on this model requires that the outside door handle on the pilot and front passenger doors be extended out whenever the doors are open. When closing the door, do not attempt to push the door handle in until the door is fully shut.

To open the doors from outside the airplane, utilize the recessed door handle near the aft edge of either door by grasping the forward edge of the handle and pulling outboard. To close or open the doors from inside the airplane, use the combination door handle and arm rest. The inside door handle has three positions and a placard at its base which reads OPEN, CLOSE, and LOCK. The handle is spring-loaded to the CLOSE (up) position. When the door has been pulled shut and latched, lock it by rotating the door handle forward to the LOCK position (flush with the arm rest). When the handle is rotated to the LOCK position, an over-center action will hold it in that position. Both cabin doors should be locked prior to flight, and should not be opened intentionally during flight.

NOTE

Accidental opening of a cabin door in flight due to improper closing does not constitute a need to land the airplane. The best procedure is to set up the airplane in a trimmed condition at approximately 75 KIAS, momentarily shove the door outward slightly, and forcefully close and lock the door.

Exit from the airplane is accomplished by rotating the door handle from the LOCK position, past the CLOSE position, aft to the OPEN position

and pushing the door open. To lock the airplane, lock the right cabin door with the inside handle, close the left cabin door, and using the ignition key, lock the door.

The left cabin door is equipped with an openable window which is held in the closed position by a detent equipped latch on the lower edge of the window frame. To open the window, rotate the latch upward. The window is equipped with a spring-loaded retaining arm which will help rotate the window outward, and hold it there. An openable window is also available for the right door, and functions in the same manner as the left window. If required, either window may be opened at any speed up to 158 KIAS. The cabin top windows (if installed), rear side windows, and rear windows are of the fixed type and cannot be opened.

CONTROL LOCKS

A control lock is provided to lock the aileron and elevator control surfaces to prevent damage to these systems by wind buffeting while the airplane is parked. The lock consists of a shaped steel rod and flag. The flag identifies it as a control lock and cautions about its removal before starting the engine. To install the control lock, align the hole in the top of the pilot's control wheel shaft with the hole in the top of the shaft collar on the instrument panel and insert the rod into the aligned holes. Installation of the lock will secure the ailerons in a neutral position and the elevators in a slightly trailing edge down position. Proper installation of the lock will place the flag over the ignition switch. In areas where high or gusty winds occur, a control surface lock should be installed over the vertical stabilizer and rudder. The control lock and any other type of locking device should be removed prior to starting the engine.

ENGINE

The airplane is powered by a horizontally-opposed, four-cylinder, overhead-valve, air-cooled, carbureted engine with a wet sump oil system. The engine is a Lycoming Model O-320-D2J and is rated at 160 horsepower at 2700 RPM. Major accessories include a starter and belt-driven alternator mounted on the front of the engine, and dual magnetos, a vacuum pump, and a full flow oil filter on the rear of the engine.

ENGINE CONTROLS

Engine power is controlled by a throttle located on the switch and control panel above the control pedestal. The throttle operates in a conventional manner; in the full forward position, the throttle is open, and in the full aft position, it is closed. A friction lock, which is a round knurled

disk, is located at the base of the throttle and is operated by rotating the lock clockwise to increase friction or counterclockwise to decrease it.

The mixture control, mounted above the right corner of the control pedestal, is a red knob with raised points around the circumference and is equipped with a lock button in the end of the knob. The rich position is full forward, and full aft is the idle cut-off position. For small adjustments, the control may be moved forward by rotating the knob clockwise, and aft by rotating the knob counterclockwise. For rapid or large adjustments, the knob may be moved forward or aft by depressing the lock button in the end of the control, and then positioning the control as desired.

ENGINE INSTRUMENTS

Engine operation is monitored by the following instruments: oil pressure gage, oil temperature gage and a tachometer. An economy mixture (EGT) indicator and a carburetor air temperature gage are also available.

The oil pressure gage, located on the left side of the instrument panel, is operated by oil pressure. A direct pressure oil line from the engine delivers oil at engine operating pressure to the oil pressure gage. Gage markings indicate that minimum idling pressure is *25 PSI (red line), the normal operating range is *60 to 90 PSI (green arc) and maximum pressure is 115 PSI (red line).

Oil temperature is indicated by a gage adjacent to the oil pressure gage. The gage is operated by an electrical-resistance type temperature sensor which receives power from the airplane electrical system. Gage markings indicate the normal operating range (green arc) which is 100°F (38°C) to 245°F (118°C) and the maximum (red line) which is 245°F (118°C).

The engine-driven mechanical tachometer is located on the instrument panel to the left of the pilot's control wheel. The instrument is calibrated in increments of 100 RPM and indicates both engine and propeller speed. An hour meter in the lower section of the dial records elapsed engine time in hours and tenths. Instrument markings include the normal operating range (multiple width green arc) of 2100 to 2700 RPM and a maximum (red line) of 2700 RPM. The multiple width green arc has steps at 2450 RPM, 2575 RPM and 2700 RPM which indicate a 75% engine power setting at altitudes of sea level, 5000 feet and 10,000 feet.

An economy mixture (EGT) indicator is available for the airplane and is located on the right side of the instrument panel. A thermocouple probe in the tailpipe measures exhaust gas temperature and transmits it to the indicator. The indicator serves as a visual aid to the pilot in adjusting cruise mixture. Exhaust gas temperature varies with fuel-to-air ratio, power and RPM. How-

* 20 psi (red line) and 50-90 psi (green arc) on airplanes modified by Service Kit SK172-81, SK172-82 or SK172-123A.

ever, the difference between peak EGT and EGT at cruise mixture setting is essentially constant, and this provides a useful leaning aid. The indicator is equipped with a manually positioned reference pointer.

A carburetor air temperature gage is available for the airplane. Details of this gage are presented in Section 9, Supplements.

NEW ENGINE BREAK-IN AND OPERATION

The engine underwent a run-in at the factory and is ready for the full range of use. It is, however, suggested that cruising be accomplished at a minimum of 75% power until a total of 50 hours has accumulated or oil consumption has stabilized. This will ensure proper seating of the rings.

ENGINE OIL SYSTEM

Oil for engine lubrication is supplied from a sump on the bottom of the engine. The capacity of the engine sump is seven quarts (one additional quart is contained in the full flow oil filter). Oil is drawn from the sump through an oil suction strainer screen into the engine-driven oil pump. From the pump, oil is routed to a bypass valve. If the oil is cold, the bypass valve allows the oil to bypass the oil cooler and go directly from the pump to the full flow oil filter. If the oil is hot, the bypass valve routes the oil out of the accessory housing and into a flexible hose leading to the oil cooler on the right rear engine baffle. Pressure oil from the cooler returns to the accessory housing where it passes through the full flow oil filter. The filter oil then enters a pressure relief valve which regulates engine oil pressure by allowing excessive oil to return to the sump while the balance of the oil is circulated to various engine parts for lubrication. Residual oil is returned to the sump by gravity flow.

An oil filler cap/oil dipstick is located at the right rear of the engine. The filler cap/dipstick is accessible through an access door on the top right side of the engine cowling. The engine should not be operated on less than five quarts of oil. For extended flight, fill to seven quarts (dipstick indication only). For engine oil grade and specifications, refer to Section 8 of this handbook.

An oil quick-drain valve is available to replace the drain plug on the bottom of the oil sump, and provides quicker, cleaner draining of the engine oil. To drain the oil with this valve, slip a hose over the end of the valve and push upward on the end of the valve until it snaps into the open position. Spring clips will hold the valve open. After draining, use a

suitable tool to snap the valve into the extended (closed) position and remove the drain hose.

IGNITION-STARTER SYSTEM

Engine ignition is provided by two engine-driven magnetos, and two spark plugs in each cylinder. The right magneto fires the lower right and upper left spark plugs, and the left magneto fires the lower left and upper right spark plugs. Normal operation is conducted with both magnetos due to the more complete burning of the fuel-air mixture with dual ignition.

Ignition and starter operation is controlled by a rotary type switch located on the left switch and control panel. The switch is labeled clockwise, OFF, R, L, BOTH, and START. The engine should be operated on both magnetos (BOTH position) except for magneto checks. The R and L positions are for checking purposes and emergency use only. When the switch is rotated to the spring-loaded START position, (with the master switch in the ON position), the starter contactor is energized and the starter will crank the engine. When the switch is released, it will automatically return to the BOTH position.

AIR INDUCTION SYSTEM

The engine air induction system receives ram air through an intake in the lower front portion of the engine cowling. The intake is covered by an air filter which removes dust and other foreign matter from the induction air. Airflow passing through the filter enters an airbox. After passing through the airbox, induction air enters the inlet in the carburetor which is under the engine, and is then ducted to the engine cylinders through intake manifold tubes. In the event carburetor ice is encountered or the intake filter becomes blocked, alternate heated air can be obtained from a shroud around an exhaust riser through a duct to a valve, in the airbox, operated by the carburetor heat control on the instrument panel. Heated air from the shroud is obtained from an unfiltered outside source. Use of full carburetor heat at full throttle will result in a loss of approximately 75 to 150 RPM.

EXHAUST SYSTEM

Exhaust gas from each cylinder passes through riser assemblies to a muffler and tailpipe. The muffler is constructed with a shroud around the outside which forms a heating chamber for cabin heater air.

CARBURETOR AND PRIMING SYSTEM

The engine is equipped with an up-draft, float-type, fixed jet carburetor mounted on the bottom of the engine. The carburetor is equipped with an enclosed accelerator pump, an idle cut-off mechanism, and a manual

mixture control. Fuel is delivered to the carburetor by gravity flow from the fuel system. In the carburetor, fuel is atomized, proportionally mixed with intake air, and delivered to the cylinders through intake manifold tubes. The proportion of atomized fuel to air may be controlled, within limits, by the mixture control on the instrument panel.

For easy starting in cold weather, the engine is equipped with a manual primer. The primer is actually a small pump which draws fuel from the fuel strainer when the plunger is pulled out, and injects it into the cylinder intake ports when the plunger is pushed back in. The plunger is equipped with a lock and, after being pushed full in, must be rotated either left or right until the knob cannot be pulled out.

COOLING SYSTEM

Ram air for engine cooling enters through two intake openings in the front of the engine cowling. The cooling air is directed around the cylinders and other areas of the engine by baffling, and is then exhausted through an opening at the bottom aft edge of the cowling. No manual cooling system control is provided.

A winterization kit is available for the airplane. Details of this kit are presented in Section 9, Supplements.

PROPELLER

The airplane is equipped with a two-bladed, fixed-pitch, one-piece forged aluminum alloy propeller which is anodized to retard corrosion. The propeller is 75 inches in diameter.

FUEL SYSTEM

The airplane may be equipped with a standard fuel system or either of two long range systems (see figure 7-6). Each system consists of two vented fuel tanks (one tank in each wing), a four-position selector valve, fuel strainer, manual primer, and carburetor. The 68-gallon long range system utilizes integral tanks and the other two systems employ removable aluminum tanks. Refer to figure 7-5 for fuel quantity data for each system.

Fuel flows by gravity from the two wing tanks to a four-position selector valve, labeled BOTH, RIGHT, LEFT, and OFF. With the selector valve in either the BOTH, LEFT, or RIGHT position, fuel flows through a strainer to the carburetor. From the carburetor, mixed fuel and air flows to the cylinders through intake manifold tubes. The manual primer draws its

FUEL QUANTITY DATA (U.S. GALLONS)				
FUEL TANKS	FUEL LEVEL (QUANTITY EACH TANK)	TOTAL FUEL	TOTAL UNUSABLE	TOTAL USABLE ALL FLIGHT CONDITIONS
STANDARD	FULL (21.5)	43	3	40
LONG RANGE	FULL (27)	54	4	50
LONG RANGE (INTEGRAL TANKS)	FULL (34)	68	6	62
	REDUCED (24)	48	6	42

Figure 7-5. Fuel Quantity Data

fuel from the fuel strainer and injects it into the cylinder intake ports.

Fuel system venting is essential to system operation. Blockage of the system will result in decreasing fuel flow and eventual engine stoppage. Venting is accomplished by an interconnecting line from the right fuel tank to the left tank. The left fuel tank is vented overboard through a vent line, equipped with a check valve, which protrudes from the bottom surface of the left wing near the wing strut. The right fuel tank filler cap is also vented.

When long range integral tanks are installed, the airplane may be serviced to a reduced capacity to permit heavier cabin loadings. This is accomplished by filling each tank to the bottom edge of the fuel filler collar, thus giving a reduced fuel load of 24 gallons in each tank (21 gallons usable in all flight conditions).

Fuel quantity is measured by two float-type fuel quantity transmitters (one in each tank) and indicated by two electrically-operated fuel quantity indicators on the left side of the instrument panel. An empty tank is indicated by a red line and the letter E. When an indicator shows an empty tank, approximately 1.5 gallons remain in a standard tank, and 2 gallons remain in a long range tank (3 gallons when long range integral tanks are installed) as unusable fuel. The indicators cannot be relied upon for accurate readings during skids, slips, or unusual attitudes.

The fuel selector valve should be in the BOTH position for takeoff,

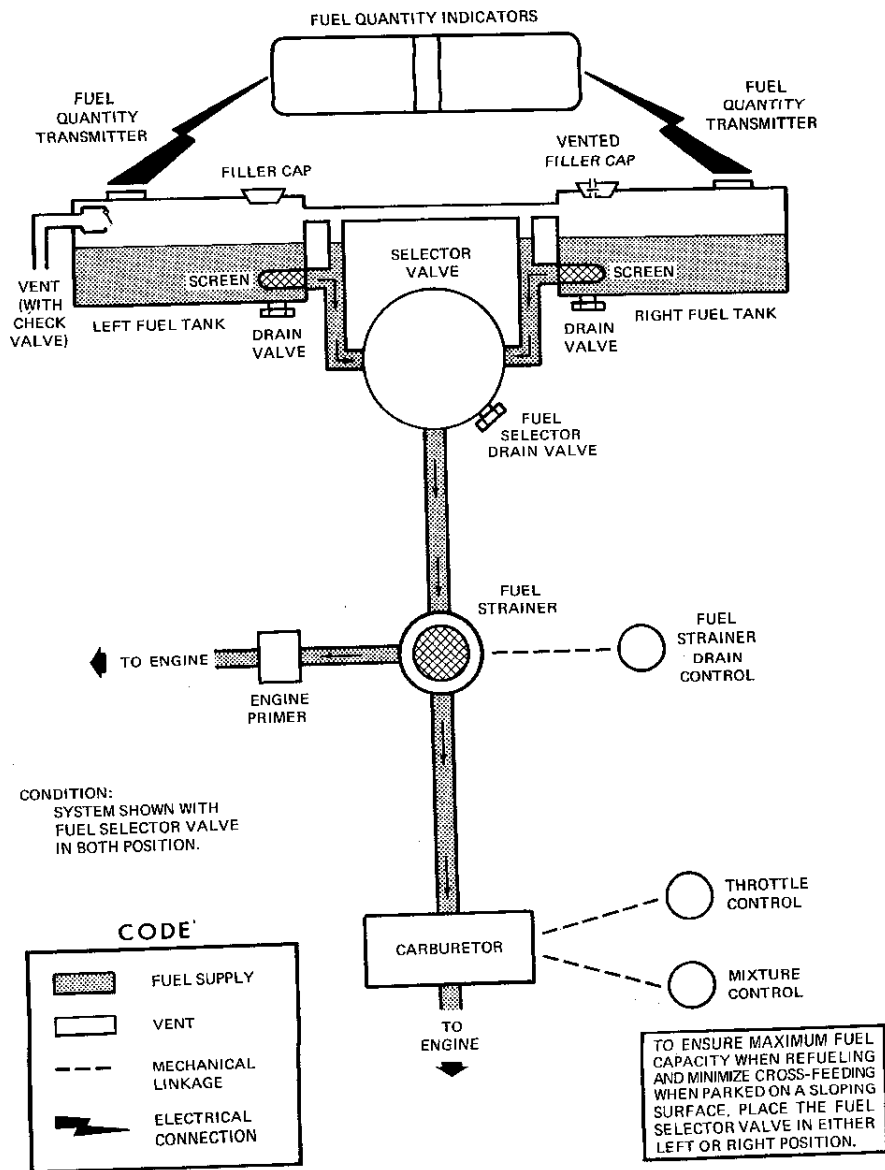

Figure 7-6. Fuel System (Standard and Long Range)

climb, landing, and maneuvers that involve prolonged slips or skids. Operation from either LEFT or RIGHT tank is reserved for cruising flight.

NOTE

When the fuel selector valve handle is in the BOTH position in cruising flight, unequal fuel flow from each tank may occur if the wings are not maintained exactly level. Resulting wing heaviness can be alleviated gradually by turning the selector valve handle to the tank in the "heavy" wing.

NOTE

When the fuel tanks are 1/4 full or less, prolonged uncoordinated flight such as slips or skids can uncover the fuel tank outlets. Therefore, if operating with one fuel tank dry or if operating on LEFT or RIGHT tank when 1/4 full or less, do not allow the airplane to remain in uncoordinated flight for periods in excess of 30 seconds.

NOTE

It is not practical to measure the time required to consume all of the fuel in one tank, and, after switching to the opposite tank, expect an equal duration from the remaining fuel. The airspace in both fuel tanks is interconnected by a vent line and, therefore, some sloshing of fuel between tanks can be expected when the tanks are nearly full and the wings are not level.

The fuel system is equipped with drain valves to provide a means for the examination of fuel in the system for contamination and grade. The system should be examined before the first flight of every day and after each refueling, by using the sampler cup provided to drain fuel from the wing tank sump drains and fuel selector drain (on the fuselage belly aft of the nosewheel). Also, drain a sample of fuel from the fuel strainer by utilizing the fuel strainer drain control under the access door on the aft right side of the top engine cowling. If takeoff weight limitations for the next flight permit, the fuel tanks should be filled after each flight to prevent condensation.

BRAKE SYSTEM

The airplane has a single-disc, hydraulically-actuated brake on each main landing gear wheel. Each brake is connected, by a hydraulic line, to a master cylinder attached to each of the pilot's rudder pedals. The brakes are operated by applying pressure to the top of either the left (pilot's) or

right (copilot's) set of rudder pedals, which are interconnected. When the airplane is parked, both main wheel brakes may be set by utilizing the parking brake which is operated by a handle under the left side of the instrument panel. To apply the parking brake, set the brakes with the rudder pedals, pull the handle aft, and rotate it 90° down.

For maximum brake life, keep the brake system properly maintained, and minimize brake usage during taxi operations and landings.

Some of the symptoms of impending brake failure are: gradual decrease in braking action after brake application, noisy or dragging brakes, soft or spongy pedals, and excessive travel and weak braking action. If any of these symptoms appear, the brake system is in need of immediate attention. If, during taxi or landing roll, braking action decreases, let up on the pedals and then re-apply the brakes with heavy pressure. If the brakes become spongy or pedal travel increases, pumping the pedals should build braking pressure. If one brake becomes weak or fails, use the other brake sparingly while using opposite rudder, as required, to offset the good brake.

ELECTRICAL SYSTEM

The airplane is equipped with a 28-volt, direct-current electrical system (see figure 7-7). The system is powered by a belt-driven, 60-amp alternator and a 24-volt battery (a heavy duty battery is available), located on the left forward side of the firewall. Power is supplied to most general electrical and all avionics circuits through the primary bus bar and the avionics bus bar, which are interconnected by an avionics power switch. The primary bus is on anytime the master switch is turned on, and is not affected by starter or external power usage. Both bus bars are on anytime the master and avionics power switches are turned on.

CAUTION

Prior to turning the master switch on or off, starting the engine or applying an external power source, the avionics power switch, labeled AVIONICS POWER, should be turned off to prevent any harmful transient voltage from damaging the avionics equipment.

MASTER SWITCH

The master switch is a split-rocker type switch labeled MASTER, and is ON in the up position and off in the down position. The right half of the

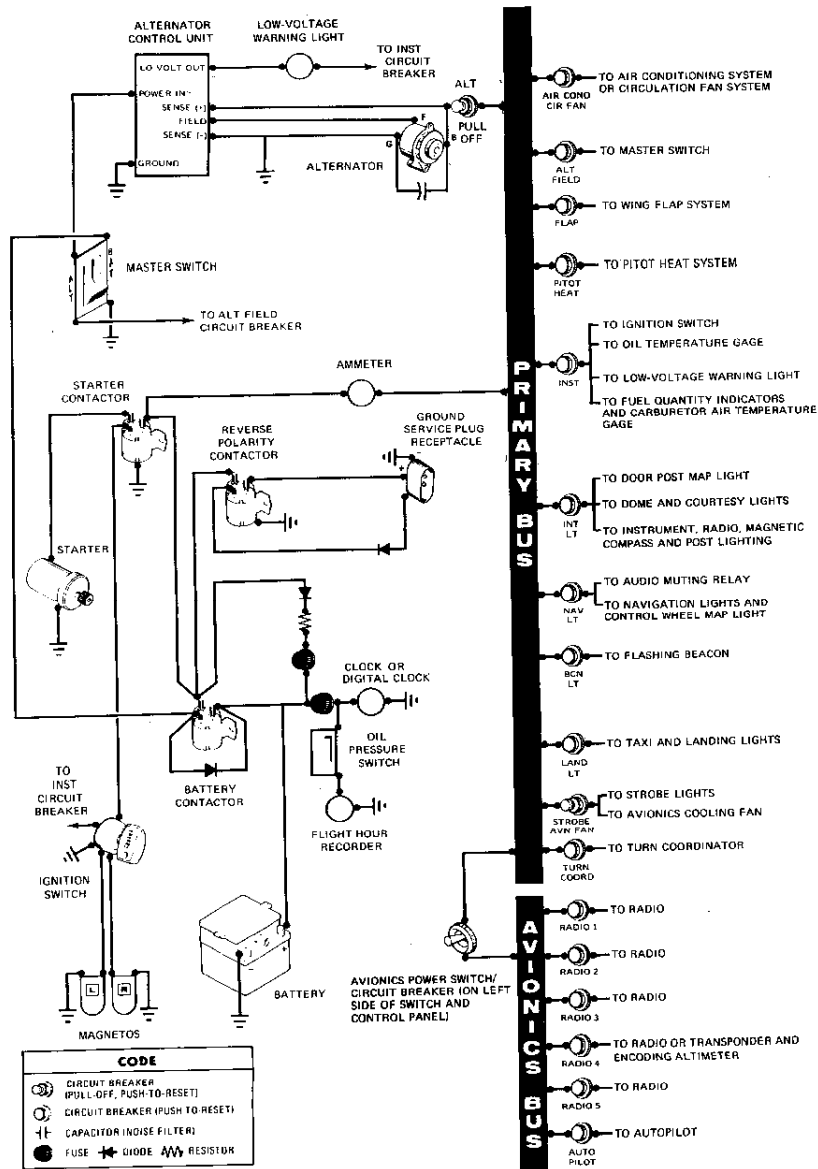

Figure 7-7. Electrical System

switch, labeled BAT, controls all electrical power to the airplane. The left half, labeled ALT, controls the alternator.

Normally, both sides of the master switch should be used simultaneously; however, the BAT side of the switch could be turned on separately to check equipment while on the ground. To check or use avionics equipment or radios while on the ground, the avionics power switch must also be turned on. The ALT side of the switch, when placed in the off position, removes the alternator from the electrical system. With this switch in the off position, the entire electrical load is placed on the battery. Continued operation with the alternator switch in the off position will reduce battery power low enough to open the battery contactor, remove power from the alternator field, and prevent alternator restart.

AVIONICS POWER SWITCH

Electrical power from the airplane primary bus to the avionics bus (see figure 7-7) is controlled by a toggle switch/circuit breaker labeled AVIONICS POWER. The switch is located on the left side of the switch and control panel and is ON in the up position and off in the down position. With the switch in the off position, no electrical power will be applied to the avionics equipment, regardless of the position of the master switch or the individual equipment switches. The avionics power switch also functions as a circuit breaker. If an electrical malfunction should occur and cause the circuit breaker to open, electrical power to the avionics equipment will be interrupted and the switch will automatically move to the off position. If this occurs, allow the circuit breaker to cool approximately two minutes before placing the switch in the ON position again. If the circuit breaker opens again, do not reset it. The avionics power switch should be placed in the off position prior to turning the master switch ON or off, starting the engine, or applying an external power source, and may be utilized in place of the individual avionics equipment switches.

AMMETER

The ammeter, located on the lower left side of the instrument panel, indicates the amount of current, in amperes, from the alternator to the battery or from the battery to the airplane electrical system. When the engine is operating and the master switch is turned on, the ammeter indicates the charging rate applied to the battery. In the event the alternator is not functioning or the electrical load exceeds the output of the alternator, the ammeter indicates the battery discharge rate.

ALTERNATOR CONTROL UNIT AND LOW-VOLTAGE WARNING LIGHT

The airplane is equipped with a combination alternator regulator

high-low voltage control unit mounted on the engine side of the firewall and a red warning light, labeled LOW VOLTAGE, on the left side of the instrument panel below the ammeter.

In the event an over-voltage condition occurs, the alternator control unit automatically removes alternator field current which shuts down the alternator. The battery will then supply system current as shown by a discharge rate on the ammeter. Under these conditions, depending on electrical system load, the low-voltage warning light will illuminate when system voltage drops below normal. The alternator control unit may be reset by turning the master switch off and back on again. If the warning light does not illuminate, normal alternator charging has resumed; however, if the light does illuminate again, a malfunction has occurred, and the flight should be terminated as soon as practicable.

NOTE

Illumination of the low-voltage light and ammeter discharge indications may occur during low RPM conditions with an electrical load on the system, such as during a low RPM taxi. Under these conditions, the light will go out at higher RPM. The master switch need not be recycled since an over-voltage condition has not occurred to de-activate the alternator system.

The warning light may be tested by turning on the landing lights and momentarily turning off the ALT portion of the master switch while leaving the BAT portion turned on.

CIRCUIT BREAKERS AND FUSES

Most of the electrical circuits in the airplane are protected by "push-to-reset" type circuit breakers mounted on the left side of the switch and control panel. However, circuit breakers protecting the alternator output and the strobe light/avionic cooling fan circuits are the "pull-off" type. In addition to the individual circuit breakers, a toggle switch/circuit breaker, labeled AVIONICS POWER, on the left side of the switch and control panel also protects the avionics systems. The control wheel map light (if installed) is protected by the NAV LT circuit breaker and a fuse behind the instrument panel. Electrical circuits which are not protected by circuit breakers are the battery contactor closing (external power) circuit, clock circuit, and flight hour recorder circuit. These circuits are protected by fuses mounted adjacent to the battery.

GROUND SERVICE PLUG RECEPTACLE

A ground service plug receptacle may be installed to permit the use of an external power source for cold weather starting and during lengthy maintenance work on the electrical and electronic equipment. Details of the ground service plug receptacle are presented in Section 9, Supplements.

LIGHTING SYSTEMS

EXTERIOR LIGHTING

Conventional navigation lights are located on the wing tips and top of the rudder, and dual landing/taxi lights are located in the left wing leading edge. Additional lighting is available and includes a flashing beacon mounted on top of the vertical fin, a strobe light on each wing tip, and a courtesy light recessed into the lower surface of each wing slightly outboard of the cabin doors. Details of the strobe light system are presented in Section 9, Supplements. The courtesy lights are operated by the DOME LIGHTS switch located on the overhead console; push the switch to the right to turn the lights on. The remaining exterior lights are operated by rocker switches located on the left switch and control panel; push the rocker up to the ON position.

The flashing beacon should not be used when flying through clouds or overcast; the flashing light reflected from water droplets or particles in the atmosphere, particularly at night, can produce vertigo and loss of orientation.

INTERIOR LIGHTING

Instrument panel and switch and control panel lighting is provided by flood lighting, integral lighting, and post lighting (if installed). Lighting intensity is controlled by a dual light dimming rheostat equipped with an outer knob labeled PANEL LT, and an inner knob labeled RADIO LT, located below the throttle. A slide-type switch (if installed) on the overhead console, labeled PANEL LIGHTS, is used to select flood lighting in the FLOOD position, post lighting in the POST position, or a combination of post and flood lighting in the BOTH position.

Instrument panel and switch and control panel flood lighting consists of a single red flood light in the forward edge of the overhead console. To use flood lighting, move the slide switch in the overhead console, labeled PANEL LIGHTS, to the FLOOD position and rotate the outer knob on the

light dimming rheostat, labeled PANEL LT, clockwise to the desired light intensity.

Post lights (if installed) are mounted at the edge of each instrument and provide direct lighting. To use post lighting, move the slide switch in the overhead console, labeled PANEL LIGHTS, to the POST position and rotate the outer knob on the light dimming rheostat, labeled PANEL LT, clockwise to obtain the desired light intensity. When the PANEL LIGHTS switch is placed in the BOTH position, the flood lights and post lights will operate simultaneously.

The engine instrument cluster (if post lights are installed), radio equipment, and magnetic compass have integral lighting and operate independently of post or flood lighting. The intensity of this lighting is controlled by the inner knob on the light dimming rheostat labeled RADIO LT; rotate the knob clockwise to obtain the desired light intensity. However, for daylight operation, the compass and engine instrument lights may be turned off while still maintaining maximum light intensity for the digital readouts in the radio equipment. This is accomplished by rotating the RADIO LT knob full counterclockwise. Check that the flood lights/post lights are turned off for daylight operation by rotating the PANEL LT knob full counterclockwise.

A cabin dome light, in the aft part of the overhead console, is operated by a switch near the light. To turn the light on, move the switch to the right.

A control wheel map light is available and is mounted on the bottom of the pilot's control wheel. The light illuminates the lower portion of the cabin just forward of the pilot and is helpful when checking maps and other flight data during night operations. To operate the light, first turn on the NAV LT switch; then adjust the map light's intensity with the knurled disk type rheostat control located at the bottom of the control wheel.

A doorpost map light is located on the left forward doorpost. It contains both red and white bulbs and may be positioned to illuminate any area desired by the pilot. The light is controlled by a switch, below the light, which is labeled RED, OFF, and WHITE. Placing the switch in the top position will provide a red light. In the bottom position, standard white lighting is provided. In the center position, the map light is turned off. Red light intensity is controlled by the outer knob on the light dimming rheostat labeled PANEL LT.

The most probable cause of a light failure is a burned out bulb; however, in the event any of the lighting systems fail to illuminate when turned on, check the appropriate circuit breaker. If the circuit breaker has opened (white button popped out), and there is no obvious indication of a

short circuit (smoke or odor), turn off the light switch of the affected lights, reset the breaker, and turn the switch on again. If the breaker opens again, do not reset it.

CABIN HEATING, VENTILATING AND DEFROSTING SYSTEM

The temperature and volume of airflow into the cabin can be regulated by manipulation of the push-pull CABIN HT and CABIN AIR control knobs (see figure 7-8).

For cabin ventilation, pull the CABIN AIR knob out. To raise the air temperature, pull the CABIN HT knob out approximately 1/4 to 1/2 inch for a small amount of cabin heat. Additional heat is available by pulling the knob out farther; maximum heat is available with the CABIN HT knob pulled out and the CABIN AIR knob pushed full in. When no heat is desired in the cabin, the CABIN HT knob is pushed full in.

Front cabin heat and ventilating air is supplied by outlet holes spaced across a cabin manifold just forward of the pilot's and copilot's feet. Rear cabin heat and air is supplied by two ducts from the manifold, one extending down each side of the cabin to an outlet at the front doorpost at floor level. Windshield defrost air is also supplied by two ducts leading from the cabin manifold to defroster outlets near the lower edge of the windshield. Two knobs control sliding valves in either defroster outlet to permit regulation of defroster airflow.

Separate adjustable ventilators supply additional air; one near each upper corner of the windshield supplies air for the pilot and copilot, and two ventilators are available for the rear cabin area to supply air to the rear seat passengers. The airplane may also be equipped with an air conditioning system. For operating instructions and details concerning this system, refer to Section 9, Supplements.

PITOT-STATIC SYSTEM AND INSTRUMENTS

The pitot-static system supplies ram air pressure to the airspeed indicator and static pressure to the airspeed indicator, vertical speed indicator and altimeter. The system is composed of either an unheated or heated pitot tube mounted on the lower surface of the left wing, an external static port on the lower left side of the forward fuselage, and the associated plumbing necessary to connect the instruments to the sources.

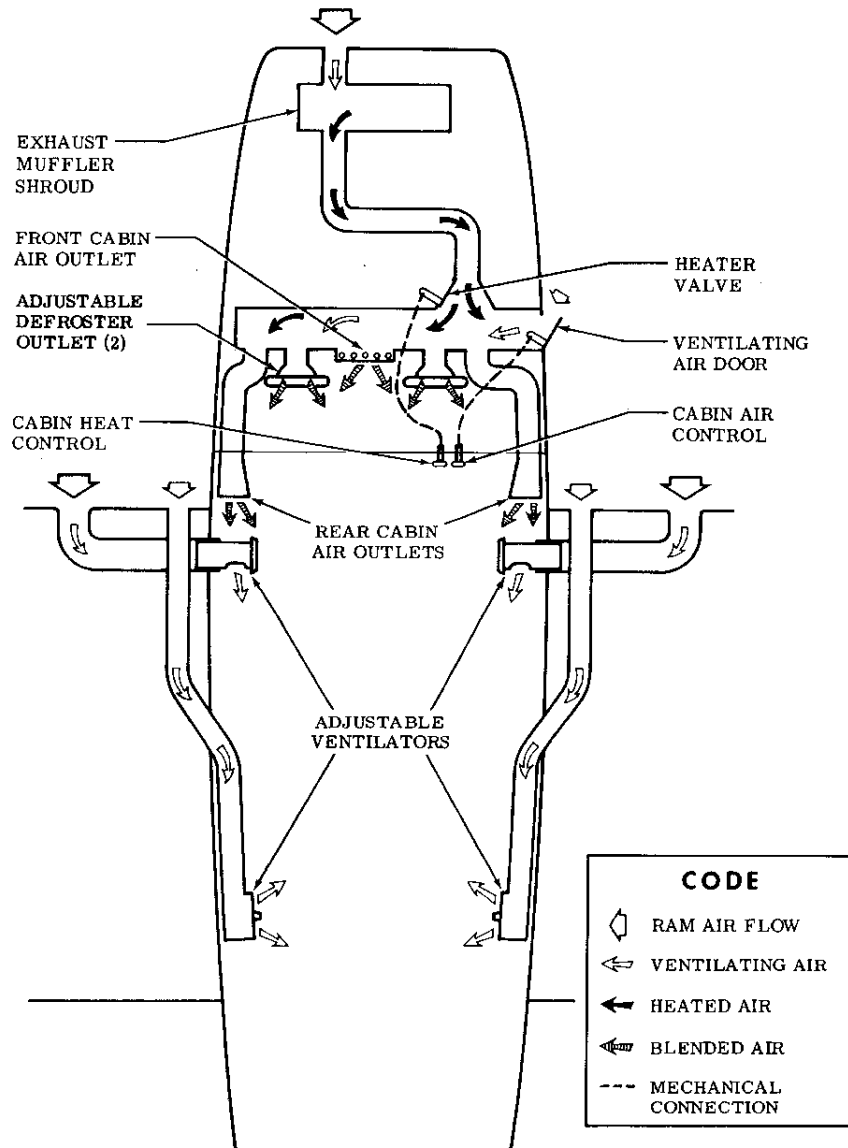

Figure 7-8. Cabin Heating, Ventilating, and Defrosting System

The heated pitot system (if installed) consists of a heating element in the pitot tube, a rocker switch labeled PITOT HT, a 5-amp circuit breaker, and associated wiring. The switch and circuit breaker are located on the left side of the switch and control panel. When the pitot heat switch is turned on, the element in the pitot tube is heated electrically to maintain proper operation in possible icing conditions. Pitot heat should be used only as required.

A static pressure alternate source valve may be installed on the switch and control panel below the throttle, and can be used if the external static source is malfunctioning. This valve supplies static pressure from inside the cabin instead of the external static port.

If erroneous instrument readings are suspected due to water or ice in the pressure line going to the standard external static pressure source, the alternate static source valve should be pulled on.

Pressures within the cabin will vary with open heater/vents and windows. Refer to Section 5 for the effect of varying cabin pressures on airspeed readings.

AIRPEED INDICATOR

The airspeed indicator is calibrated in knots and miles per hour. Limitation and range markings (in KIAS) include the white arc (33 to 85 knots), green arc (44 to 127 knots), yellow arc (127 to 158 knots), and a red line (158 knots).

If a true airspeed indicator is installed, it is equipped with a rotatable ring which works in conjunction with the airspeed indicator dial in a manner similar to the operation of a flight computer. To operate the indicator, first rotate the ring until pressure altitude is aligned with outside air temperature in degrees Fahrenheit. Pressure altitude should not be confused with indicated altitude. To obtain pressure altitude, momentarily set the barometric scale on the altimeter to 29.92 and read pressure altitude on the altimeter. Be sure to return the altimeter barometric scale to the original barometric setting after pressure altitude has been obtained. Having set the ring to correct for altitude and temperature, read the true airspeed shown on the rotatable ring by the indicator pointer. For best accuracy, the indicated airspeed should be corrected to calibrated airspeed by referring to the Airspeed Calibration chart in Section 5. Knowing the calibrated airspeed, read true airspeed on the ring opposite the calibrated airspeed.

VERTICAL SPEED INDICATOR

The vertical speed indicator depicts airplane rate of climb or descent in feet per minute. The pointer is actuated by atmospheric pressure changes resulting from changes of altitude as supplied by the static source.

ALTIMETER

Airplane altitude is depicted by a barometric type altimeter. A knob near the lower left portion of the indicator provides adjustment of the instrument's barometric scale to the current altimeter setting.

VACUUM SYSTEM AND INSTRUMENTS

An engine-driven vacuum system (see figure 7-9) provides the suction necessary to operate the attitude indicator and directional indicator. The system consists of a vacuum pump mounted on the engine, a vacuum relief valve and vacuum system air filter on the aft side of the firewall below the instrument panel, and instruments (including a suction gage) on the left side of the instrument panel.

ATTITUDE INDICATOR

The attitude indicator gives a visual indication of flight attitude. Bank attitude is presented by a pointer at the top of the indicator relative to the bank scale which has index marks at 10°, 20°, 30°, 60°, and 90° either side of the center mark. Pitch and roll attitudes are presented by a miniature airplane superimposed over a symbolic horizon area divided into two sections by a white horizon bar. The upper "blue sky" area and the lower "ground" area have arbitrary pitch reference lines useful for pitch attitude control. A knob at the bottom of the instrument is provided for in-flight adjustment of the miniature airplane to the horizon bar for a more accurate flight attitude indication.

DIRECTIONAL INDICATOR

A directional indicator displays airplane heading on a compass card in relation to a fixed simulated airplane image and index. The indicator will precess slightly over a period of time. Therefore, the compass card should be set in accordance with the magnetic compass just prior to takeoff, and occasionally re-adjusted on extended flights. A knob on the lower left edge of the instrument is used to adjust the compass card to correct for precession.

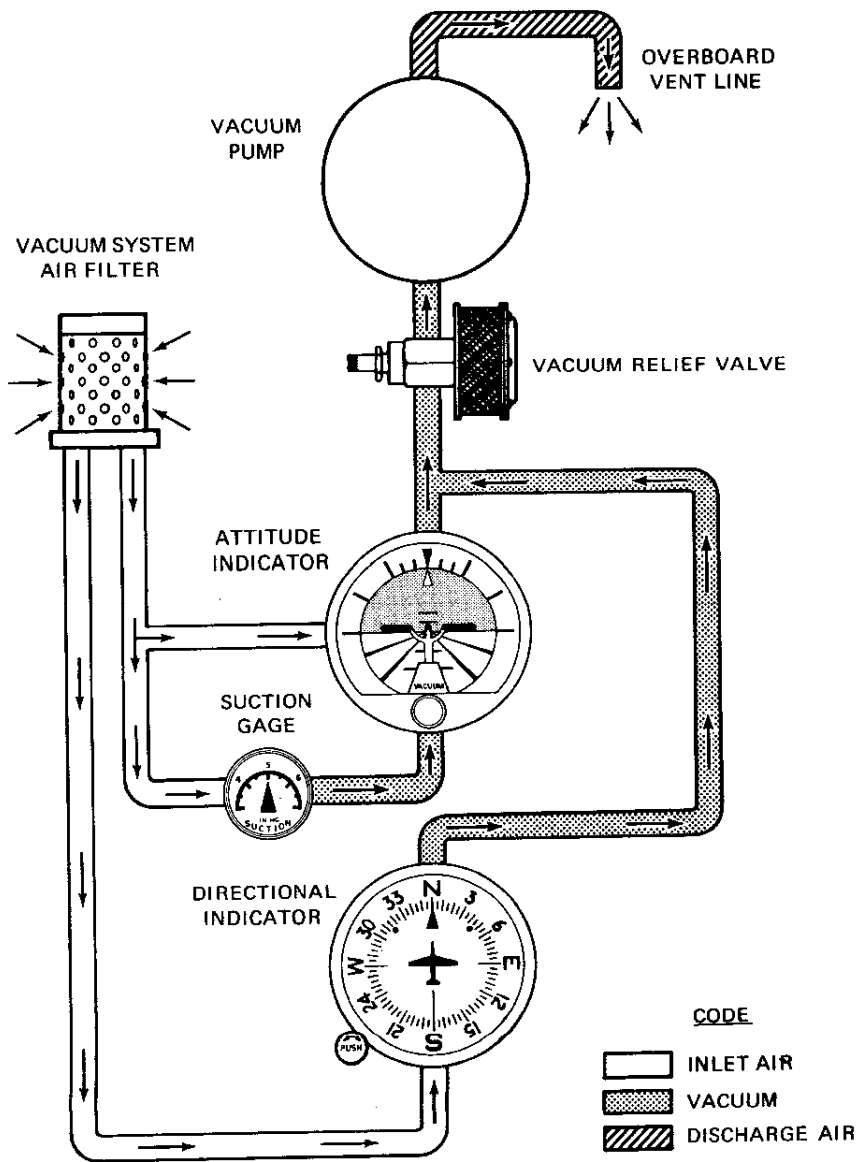

Figure 7-9. Vacuum System

SUCTION GAGE

The suction gage, located on the left side of the instrument panel, is calibrated in inches of mercury and indicates suction available for operation of the attitude and directional indicators. The desired suction range is 4.5 to 5.4 inches of mercury. A suction reading out of this range may indicate a system malfunction or improper adjustment, and in this case, the indicators should not be considered reliable.

STALL WARNING SYSTEM

The airplane is equipped with a pneumatic-type stall warning system consisting of an inlet in the leading edge of the left wing, an air-operated horn near the upper left corner of the windshield, and associated plumbing. As the airplane approaches a stall, the low pressure on the upper surface of the wings moves forward around the leading edge of the wings. This low pressure creates a differential pressure in the stall warning system which draws air through the warning horn, resulting in an audible warning at 5 to 10 knots above stall in all flight conditions.

The stall warning system should be checked during the preflight inspection by placing a clean handkerchief over the vent opening and applying suction. A sound from the warning horn will confirm that the system is operative.

AVIONICS SUPPORT EQUIPMENT

If the airplane is equipped with avionics, various avionics support equipment may also be installed. Equipment available includes an avionics cooling fan, microphone-headset installations and control surface static dischargers. The following paragraphs discuss these items. Description and operation of radio equipment is covered in Section 9 of this handbook.

AVIONICS COOLING FAN

An avionics cooling fan system is provided whenever a factory-installed Nav/Com radio is installed. The system is designed to provide internal cooling air from a small electric fan to the avionics units and thereby eliminate the possibility of moisture contamination using an external cooling air source.

Power to the electric fan is supplied directly from a "pull-off" type

circuit breaker labeled STROBE, AVN FAN, located on the left switch and control panel. Hence, power is supplied to the fan anytime the master switch is ON. This arrangement provides air circulation through the radios to remove a possible heat soak condition before the radios are turned on after engine start. It is recommended that the circuit breaker be left ON except during periods of lengthy maintenance with the master switch ON.

MICROPHONE-HEADSET INSTALLATIONS

Three types of microphone-headset installations are offered. The standard system provided with avionics equipment includes a hand-held microphone and separate headset. The keying switch for this microphone is on the microphone. Two optional microphone-headset installations are also available; these feature a single-unit microphone-headset combination which permits the pilot or front passenger to conduct radio communications without interrupting other control operations to handle a hand-held microphone. One microphone-headset combination is a lightweight type without a padded headset and the other version has a padded headset. The microphone-headset combinations utilize a remote keying switch located on the left grip of the pilot's control wheel and, if an optional intercom system is installed, a second switch on the right grip of the front passenger's control wheel. The microphone and headset jacks are located on the lower left and right sides of the instrument panel. Audio to all three headsets is controlled by the individual audio selector switches and adjusted for volume level by using the selected receiver volume controls.

NOTE

When transmitting, with the hand-held microphone, the pilot should key the microphone, place the microphone as close as possible to the lips and speak directly into it.

STATIC DISCHARGERS

If frequent IFR flights are planned, installation of wick-type static dischargers is recommended to improve radio communications during flight through dust or various forms of precipitation (rain, snow or ice crystals). Under these conditions, the build-up and discharge of static electricity from the trailing edges of the wings, rudder, elevator, propeller tips and radio antennas can result in loss of usable radio signals on all communications and navigation radio equipment. Usually the ADF is first to be affected and VHF communication equipment is the last to be affected.

Installation of static dischargers reduces interference from precipitation static, but it is possible to encounter severe precipitation static conditions which might cause the loss of radio signals, even with static

CESSNA
MODEL 172P

SECTION 7
AIRPLANE & SYSTEMS DESCRIPTIONS

dischargers installed. Whenever possible, avoid known severe precipitation areas to prevent loss of dependable radio signals. If avoidance is impractical, minimize airspeed and anticipate temporary loss of radio signals while in these areas.

12 May 1981

7-37/(7-38 blank)

SECTION 8

AIRPLANE HANDLING, SERVICE & MAINTENANCE

TABLE OF CONTENTS

	Page
Introduction	8-3
Identification Plate	8-3
Owner Notification System	8-3
Publications	8-3
Airplane File	8-4
Airplane Inspection Periods	8-5
FAA Required Inspections	8-5
Cessna Progressive Care	8-6
Cessna Customer Care Program	8-6
Pilot Conducted Preventive Maintenance	8-7
Alterations Or Repairs	8-7
Ground Handling	8-7
Towing	8-7
Parking	8-8
Tie-Down	8-8
Jacking	8-8
Leveling	8-9
Flyable Storage	8-9
Servicing	8-10
Engine Oil	8-10
Fuel	8-12
Landing Gear	8-15
Cleaning And Care	8-15
Windshield-Windows	8-15
Painted Surfaces	8-16
Stabilizer Abrasion Boot Care	8-17
Propeller Care	8-17
Engine Care	8-17
Interior Care	8-17
Bulb Replacement During Flight	8-19

INTRODUCTION

This section contains factory-recommended procedures for proper ground handling and routine care and servicing of your Cessna. It also identifies certain inspection and maintenance requirements which must be followed if your airplane is to retain that new-plane performance and dependability. It is wise to follow a planned schedule of lubrication and preventive maintenance based on climatic and flying conditions encountered in your locality.

Keep in touch with your Cessna Dealer and take advantage of his knowledge and experience. He knows your airplane and how to maintain it. He will remind you when lubrications and oil changes are necessary, and about other seasonal and periodic services.

IDENTIFICATION PLATE

All correspondence regarding your airplane should include the SERIAL NUMBER. The Serial Number, Model Number, Production Certificate Number (PC) and Type Certificate Number (TC) can be found on the Identification Plate, located on the lower part of the left forward doorpost. Located adjacent to the Identification Plate is a Finish and Trim Plate which contains a code describing the interior color scheme and exterior paint combination of the airplane. The code may be used in conjunction with an applicable Parts Catalog if finish and trim information is needed.

OWNER NOTIFICATION SYSTEM

As the owner of a Cessna, you will receive applicable Cessna Owner Advisories at no charge. These Owner Advisories will be mailed to the address that is provided to Cessna on the Warranty Registration Application Card which is included in your Customer Care Handbook. A subscription service for Service Information Letters is available directly from the Cessna Customer Services Department. Your Cessna Dealer will be glad to supply you with details concerning this subscription program, and stands ready, through his Service Department, to supply you with fast, efficient, low-cost service.

PUBLICATIONS

Various publications and flight operation aids are furnished in the

**SECTION 8
HANDLING, SERVICE
& MAINTENANCE**

**CESSNA
MODEL 172P**

airplane when delivered from the factory. These items are listed below.

- CUSTOMER CARE PROGRAM BOOK
- PILOT'S OPERATING HANDBOOK AND FAA APPROVED AIRPLANE FLIGHT MANUAL
- PILOT'S CHECKLISTS
- POWER COMPUTER
- WORLDWIDE CUSTOMER CARE DIRECTORY

The following additional publications, plus many other supplies that are applicable to your airplane, are available from your Cessna Dealer.

- INFORMATION MANUAL (Contains Pilot's Operating Handbook Information)
- SERVICE MANUALS AND PARTS CATALOGS FOR YOUR:
AIRPLANE
ENGINE AND ACCESSORIES
AVIONICS AND AUTOPILOT

Your Cessna Dealer has a Customer Care Supplies Catalog covering all available items, many of which he keeps on hand. He will be happy to place an order for any item which is not in stock.

NOTE

A Pilot's Operating Handbook and FAA Approved Airplane Flight Manual which is lost or destroyed may be replaced by contacting your Cessna Dealer or writing directly to the Customer Services Department, Cessna Aircraft Company, Wichita, Kansas. An affidavit containing the owner's name, airplane serial number and registration number must be included in replacement requests since the Pilot's Operating Handbook and FAA Approved Airplane Flight Manual is identified for specific airplanes only.

AIRPLANE FILE

There are miscellaneous data, information and licenses that are a part of the airplane file. The following is a checklist for that file. In addition, a periodic check should be made of the latest Federal Aviation Regulations to ensure that all data requirements are met.

- A. To be displayed in the airplane at all times:
 - 1. Aircraft Airworthiness Certificate (FAA Form 8100-2).
 - 2. Aircraft Registration Certificate (FAA Form 8050-3).
 - 3. Aircraft Radio Station License, if transmitter installed (FCC Form 556).
- B. To be carried in the airplane at all times:
 - 1. Pilot's Operating Handbook and FAA Approved Airplane Flight Manual.
 - 2. Weight and Balance, and associated papers (latest copy of the Repair and Alteration Form, FAA Form 337, if applicable).
 - 3. Equipment List.
- C. To be made available upon request:
 - 1. Airplane Log Book.
 - 2. Engine Log Book.

Most of the items listed are required by the United States Federal Aviation Regulations. Since the Regulations of other nations may require other documents and data, owners of airplanes not registered in the United States should check with their own aviation officials to determine their individual requirements.

Cessna recommends that these items, plus the Pilot's Checklists, Power Computer, Customer Care Program book and Customer Care Card, be carried in the airplane at all times.

AIRPLANE INSPECTION PERIODS

FAA REQUIRED INSPECTIONS

As required by Federal Aviation Regulations, all civil aircraft of U.S. registry must undergo a complete inspection (annual) each twelve calendar months. In addition to the required ANNUAL inspection, aircraft operated commercially (for hire) must have a complete inspection every 100 hours of operation.

The FAA may require other inspections by the issuance of airworthiness directives applicable to the airplane, engine, propeller and components. It is the responsibility of the owner/operator to ensure compliance with all applicable airworthiness directives and, when the inspections are repetitive, to take appropriate steps to prevent inadvertent noncompliance.

In lieu of the 100 HOUR and ANNUAL inspection requirements, an airplane may be inspected in accordance with a progressive inspection schedule, which allows the work load to be divided into smaller operations that can be accomplished in shorter time periods.

**SECTION 8
HANDLING, SERVICE
& MAINTENANCE**

**CESSNA
MODEL 172P**

The CESSNA PROGRESSIVE CARE PROGRAM has been developed to provide a modern progressive inspection schedule that satisfies the complete airplane inspection requirements of both the 100 HOUR and ANNUAL inspections as applicable to Cessna airplanes. The program assists the owner in his responsibility to comply with all FAA inspection requirements, while ensuring timely replacement of life-limited parts and adherence to factory-recommended inspection intervals and maintenance procedures.

CESSNA PROGRESSIVE CARE

The Cessna Progressive Care Program has been designed to help you realize maximum utilization of your airplane at a minimum cost and downtime. Under this program, the inspection and maintenance work load is divided into smaller operations that can be accomplished in shorter time periods. The operations are recorded in a specially provided Aircraft Inspection Log as each operation is conducted.

While Progressive Care may be used on any Cessna, its benefits depend primarily on the utilization (hours flown per year) and type of operation. The procedures for both the Progressive Care Program and the 100-hour/annual inspection program have been carefully worked out by the factory and are followed by the Cessna Dealer Organization. Your Cessna Dealer can assist you in selecting the inspection program most suitable for your type of aircraft and operation. The complete familiarity of Cessna Dealers with Cessna equipment and factory-approved procedures provides the highest level of service possible at lower cost to Cessna owners.

Regardless of the inspection method selected by the owner, he should keep in mind that FAR Part 43 and FAR Part 91 establishes the requirement that properly certified agencies or personnel accomplish all required FAA inspections and most of the manufacturer recommended inspections.

CESSNA CUSTOMER CARE PROGRAM

Specific benefits and provisions of the CESSNA WARRANTY plus other important benefits for you are contained in your CUSTOMER CARE PROGRAM book supplied with your airplane. You will want to thoroughly review your Customer Care Program book and keep it in your airplane at all times.

Coupons attached to the Program book entitle you to an initial inspection and either a Progressive Care Operation No. 1 or the first 100-hour inspection within the first 6 months of ownership at no charge to you. If you take delivery from your Dealer, the initial inspection will have been performed before delivery of the airplane to you. If you pick up your airplane at the factory, plan to take it to your Dealer reasonably soon after

you take delivery, so the initial inspection may be performed allowing the Dealer to make any minor adjustments which may be necessary.

You will also want to return to your Dealer either for your first Progressive Care Operation, or at 100 hours for your first 100-hour inspection depending on which program you choose to establish for your airplane. While these important inspections will be performed for you by any Cessna Dealer, in most cases you will prefer to have the Dealer from whom you purchased the airplane accomplish this work.

PILOT CONDUCTED PREVENTIVE MAINTENANCE

A certified pilot who owns or operates an airplane not used as an air carrier is authorized by FAR Part 43 to perform limited maintenance on his airplane. Refer to FAR Part 43 for a list of the specific maintenance operations which are allowed.

NOTE

Pilots operating airplanes of other than U.S. registry should refer to the regulations of the country of certification for information on preventive maintenance that may be performed by pilots.

A Service Manual should be obtained prior to performing any preventive maintenance to ensure that proper procedures are followed. Your Cessna Dealer should be contacted for further information or for required maintenance which must be accomplished by appropriately licensed personnel.

ALTERATIONS OR REPAIRS

It is essential that the FAA be contacted prior to any alterations on the airplane to ensure that airworthiness of the airplane is not violated. Alterations or repairs to the airplane must be accomplished by licensed personnel.

GROUND HANDLING

TOWING

The airplane is most easily and safely maneuvered by hand with the tow-bar attached to the nose wheel. When towing with a vehicle, do not exceed the nose gear turning angle of 30° either side of center, or damage to the gear will result. If the airplane is towed or pushed over a rough surface during hangaring, watch that the normal cushioning action of the nose strut does not cause excessive vertical movement of the tail and the

**SECTION 8
HANDLING, SERVICE
& MAINTENANCE**

**CESSNA
MODEL 172P**

resulting contact with low hangar doors or structure. A flat nose tire or deflated strut will also increase tail height.

PARKING

When parking the airplane, head into the wind and set the parking brakes. Do not set the parking brakes during cold weather when accumulated moisture may freeze the brakes, or when the brakes are overheated. Install the control wheel lock and chock the wheels. In severe weather and high wind conditions, tie the airplane down as outlined in the following paragraph.

TIE-DOWN

Proper tie-down procedure is the best precaution against damage to the parked airplane by gusty or strong winds. To tie-down the airplane securely, proceed as follows:

1. Set the parking brake and install the control wheel lock.
2. Install a surface control lock over the fin and rudder.
3. Tie sufficiently strong ropes or chains (700 pounds tensile strength) to the wing, tail, and nose tie-down fittings and secure each rope or chain to a ramp tie-down.
4. Install a pitot tube cover.

JACKING

When a requirement exists to jack the entire airplane off the ground, or when wing jack points are used in the jacking operation, refer to the Service Manual for specific procedures and equipment required.

Individual main gear may be jacked by using the jack pad which is incorporated in the main landing gear strut step bracket. When using the individual gear strut jack pad, flexibility of the gear strut will cause the main wheel to slide inboard as the wheel is raised, tilting the jack. The jack must then be lowered for a second jacking operation. **Do not** jack both main wheels simultaneously using the individual main gear jack pads.

If nose gear maintenance is required, the nose wheel may be raised off the ground by pressing down on a tailcone bulkhead, just forward of the horizontal stabilizer, and allowing the tail to rest on the tail tie-down ring.

NOTE

Do not apply pressure on the elevator or outboard stabilizer surfaces. When pushing on the tailcone, always apply pressure at a bulkhead to avoid buckling the skin.

To assist in raising and holding the nose wheel off the ground, weight

down the tail by placing sand-bags, or suitable weights, on each side of the horizontal stabilizer, next to the fuselage. If ground anchors are available, the tail should be securely tied down.

NOTE

Ensure that the nose will be held off the ground under all conditions by means of suitable stands or supports under weight supporting bulkheads near the nose of the airplane.

LEVELING

Longitudinal leveling of the airplane is accomplished by placing a level on leveling screws located on the left side of the tailcone. Deflate the nose tire and/or lower or raise the nose strut to properly center the bubble in the level. Corresponding points on both upper door sills may be used to level the airplane laterally.

FLYABLE STORAGE

Airplanes placed in non-operational storage for a maximum of 30 days or those which receive only intermittent operational use for the first 25 hours are considered in flyable storage status. Every seventh day during these periods, the propeller should be rotated by hand through five revolutions. This action "limbers" the oil and prevents any accumulation of corrosion on engine cylinder walls.

WARNING

For maximum safety, check that the ignition switch is OFF, the throttle is closed, the mixture control is in the idle cut-off position, and the airplane is secured before rotating the propeller by hand. Do not stand within the arc of the propeller blades while turning the propeller.

After 30 days, the airplane should be flown for 30 minutes or a ground runup should be made just long enough to produce an oil temperature within the lower green arc range. Excessive ground runup should be avoided.

Engine runup also helps to eliminate excessive accumulations of water in the fuel system and other air spaces in the engine. Keep fuel tanks full to minimize condensation in the tanks. Keep the battery fully charged to prevent the electrolyte from freezing in cold weather. If the airplane is to be stored temporarily, or indefinitely, refer to the Service Manual for proper storage procedures.

SERVICING

In addition to the PREFLIGHT INSPECTION covered in Section 4, COMPLETE servicing, inspection, and test requirements for your airplane are detailed in the Service Manual. The Service Manual outlines all items which require attention at specific intervals plus those items which require servicing, inspection, and/or testing at special intervals.

Since Cessna Dealers conduct all service, inspection, and test procedures in accordance with applicable Service Manuals, it is recommended that you contact your Cessna Dealer concerning these requirements and begin scheduling your airplane for service at the recommended intervals.

Cessna Progressive Care ensures that these requirements are accomplished at the required intervals to comply with the 100-hour or ANNUAL inspection as previously covered.

Depending on various flight operations, your local Government Aviation Agency may require additional service, inspections, or tests. For these regulatory requirements, owners should check with local aviation officials where the airplane is being operated.

For quick and ready reference, quantities, materials, and specifications for frequently used service items are as follows.

ENGINE OIL

GRADE AND VISCOSITY FOR TEMPERATURE RANGE --

The airplane was delivered from the factory with aviation grade straight mineral oil. This oil should be drained after the first 25 hours of operation, and the following oils used as specified for the average ambient air temperature in the operating area.

MIL-L-6082 Aviation Grade Straight Mineral Oil: Use to replenish supply during the first 25 hours and at the first 25-hour oil change. Continue to use until a total of 50 hours has accumulated or oil consumption has stabilized.

All temperatures, use SAE 20W-50 or
Above 16°C (60°F), use SAE 50
-1°C (30°F) to 32°C (90°F), use SAE 40
-18°C (0°F) to 21°C (70°F), use SAE 30
Below -12°C (10°F), use SAE 20

MIL-L-22851 Ashless Dispersant Oil: This oil **must be used** after the first 50 hours or oil consumption has stabilized.

All temperatures, use SAE 20W-50 or
Above 16°C (60°F), use SAE 40 or SAE 50

-1°C (30°F) to 32°C (90°F), use SAE 40
-18°C (0°F) to 21°C (70°F), use SAE 40 or SAE 30
Below -12°C (10°F), use SAE 30

CAPACITY OF ENGINE SUMP -- 7 Quarts.

Do not operate on less than 5 quarts. For extended flight, fill to 7 quarts. These quantities refer to oil dipstick level readings. During oil and oil filter changes, one additional quart is required.

OIL AND OIL FILTER CHANGE --

After the first 25 hours of operation, drain engine oil sump and replace filter. Refill sump with straight mineral oil and use until a total of 50 hours has accumulated or oil consumption has stabilized; then change to dispersant oil. Drain the engine oil sump and replace the filter each 50 hours thereafter. The oil change interval may be extended to 100-hour intervals, providing the oil filter is changed at 50-hour intervals. Change engine oil and replace the filter at least every 6 months even though less than the recommended hours have accumulated. Reduce intervals for prolonged operation in dusty areas, cold climates, or when short flights and long idle periods result in sludging conditions.

NOTE

During the first 25-hour oil and filter change, a general inspection of the overall engine compartment is required. Items which are not normally checked during a preflight inspection should be given special attention. Hoses, metal lines and fittings should be inspected for signs of oil and fuel leaks, and checked for abrasions, chafing, security, proper routing and support, and evidence of deterioration. Inspect the intake and exhaust systems for cracks, evidence of leakage, and security of attachment. Engine controls and linkages should be checked for freedom of movement through their full range, security of attachment and evidence of wear. Inspect wiring for security, chafing, burning, defective insulation, loose or broken terminals, heat deterioration, and corroded terminals. Check the alternator belt in accordance with Service Manual instructions, and retighten if necessary. A periodic check of these items during subsequent servicing operations is recommended.

**SECTION 8
HANDLING, SERVICING
& MAINTENANCE**

**CESSNA
MODEL 172P**

FUEL

APPROVED FUEL GRADES (AND COLORS) --
100LL Grade Aviation Fuel (Blue).
100 (Formerly 100/130) Grade Aviation Fuel (Green).

NOTE

Isopropyl alcohol or ethylene glycol monomethyl ether may be added to the fuel supply in quantities not to exceed 1% or .15% by volume, respectively, of the total. Refer to Fuel Additives in later paragraphs for additional information.

CAPACITY EACH STANDARD TANK -- 21.5 Gallons.
CAPACITY EACH LONG RANGE TANK -- 27 Gallons.
CAPACITY EACH INTEGRAL TANK -- 34 Gallons.

NOTE

To ensure maximum fuel capacity when refueling and minimize cross-feeding when parked on a sloping surface, place the fuel selector valve in either LEFT or RIGHT position.

NOTE

Service the fuel system after each flight, and keep fuel tanks full to minimize condensation in the tanks.

FUEL ADDITIVES --

Strict adherence to recommended preflight draining instructions as called for in Section 4 will eliminate any free water accumulations from the tank sumps. While small amounts of water may still remain in solution in the gasoline, it will normally be consumed and go unnoticed in the operation of the engine.

One exception to this can be encountered when operating under the combined effect of: (1) use of certain fuels, with (2) high humidity conditions on the ground (3) followed by flight at high altitude and low temperature. Under these unusual conditions, small amounts of water in solution can precipitate from the fuel stream and freeze in sufficient quantities to induce partial icing of the engine fuel system.

While these conditions are quite rare and will not normally pose a problem to owners and operators, they do exist in certain areas of the world and consequently must be dealt with, when encountered.

Therefore, to alleviate the possibility of fuel icing occurring under these unusual conditions, it is permissible to add isopropyl alcohol or ethylene glycol monomethyl ether (EGME) compound to the fuel supply.

The introduction of alcohol or EGME compound into the fuel provides two distinct effects: (1) it absorbs the dissolved water from the gasoline and (2) alcohol has a freezing temperature depressant effect.

Alcohol, if used, is to be blended with the fuel in a concentration of 1% by volume. Concentrations greater than 1% are not recommended since they can be detrimental to fuel tank materials.

The manner in which the alcohol is added to the fuel is significant because alcohol is most effective when it is completely dissolved in the fuel. To ensure proper mixing, the following is recommended:

1. For best results, the alcohol should be added during the fueling operation by pouring the alcohol directly on the fuel stream issuing from the fueling nozzle.
2. An alternate method that may be used is to premix the complete alcohol dosage with some fuel in a separate clean container (approximately 2-3 gallon capacity) and then transferring this mixture to the tank prior to the fuel operation.

Any high quality isopropyl alcohol may be used, such as Anti-Icing Fluid (MIL-F-5566) or Isopropyl Alcohol (Federal Specification TT-I-735a). Figure 8-1 provides alcohol-fuel mixing ratio information.

Ethylene glycol monomethyl ether (EGME) compound, in compliance with MIL-I-27686 or Phillips PFA-55MB, if used, must be carefully mixed with the fuel in concentrations not to exceed .15% by volume. Figure 8-1 provides EGME-fuel mixing ratio information.

CAUTION

Mixing of the EGME compound with the fuel is extremely important because a concentration in excess of that recommended (.15% by volume maximum) will result in detrimental effects to the fuel tanks, such as deterioration of protective primer and sealants and damage to O-rings and seals in the fuel system and engine components. Use only blending equipment that is recommended by the manufacturer to obtain proper proportioning.

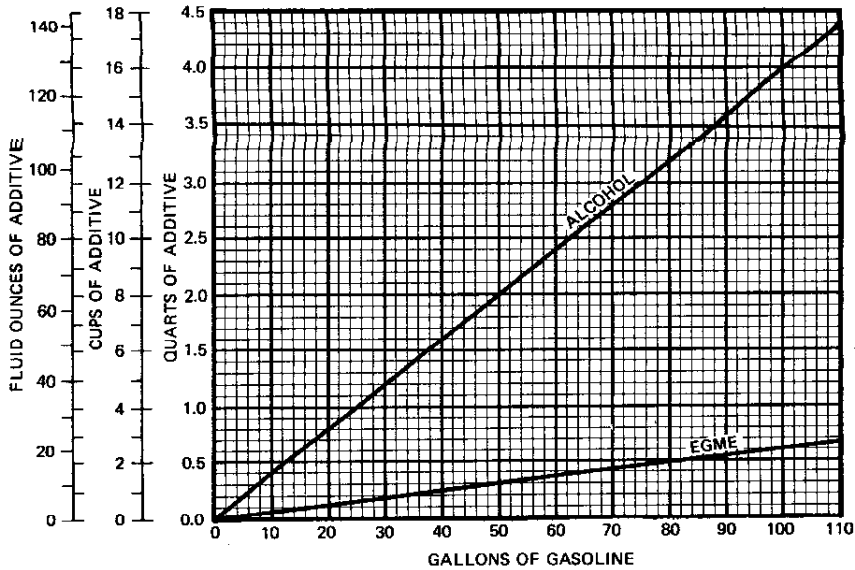

Figure 8-1. Additive Mixing Ratio

CAUTION

Do not allow the concentrated EGME compound to come in contact with the airplane finish or fuel cell as damage can result.

Prolonged storage of the airplane will result in a water buildup in the fuel which "leeches out" the additive. An indication of this is when an excessive amount of water accumulates in the fuel tank sumps. The concentration can be checked using a differential refractometer. It is imperative that the technical manual for the differential refractometer be followed explicitly when checking the additive concentration.

FUEL CONTAMINATION --

Fuel contamination is usually the result of foreign material present in the fuel system, and may consist of water, rust, sand, dirt, microbes or bacterial growth. In addition, additives that are not compatible with fuel or fuel system components can cause the fuel to become contaminated.

Before the first flight of the day and after each refueling, use a clear

sampler cup and drain a cupful of fuel from the fuel tank sump and fuel selector quick-drain valves to determine if contaminants are present, and that the airplane has been fueled with the proper grade of fuel. Also, the fuel strainer should be drained by pulling out the strainer knob for at least four seconds.

If contamination is detected, continue draining from all fuel drain points until all contamination has been removed. If the airplane has been serviced with the improper fuel grade, defuel completely and refuel with the correct grade. Do not fly the airplane with contaminated or unapproved fuel.

In addition, Owners/Operators who are not acquainted with a particular fixed base operator should be assured that the fuel supply has been checked for contamination and is properly filtered before allowing the airplane to be serviced. Also, fuel tanks should be kept full between flights, provided weight and balance considerations will permit, to reduce the possibility of water condensing on the walls of partially filled tanks.

To further reduce the possibility of contaminated fuel, routine maintenance of the fuel system should be performed in accordance with the airplane Service Manual. Only the proper fuel, as recommended in this handbook, should be used, and fuel additives should not be used unless approved by Cessna and the Federal Aviation Administration.

LANDING GEAR

NOSE WHEEL TIRE PRESSURE -- 34 PSI on 5.00-5, 6-Ply Rated Tire.

MAIN WHEEL TIRE PRESSURE -- 28 PSI on 6.00-6, 4-Ply Rated Tires.

NOSE GEAR SHOCK STRUT --

Keep filled with MIL-H-5606 hydraulic fluid per filling instructions placard, and with no load on the strut, inflate with air to 45 PSI. Do not over-inflate.

BRAKES -- Service as required with MIL-H-5606 hydraulic fluid.

CLEANING AND CARE

WINDSHIELD-WINDOWS

The plastic windshield and windows should be cleaned with an aircraft windshield cleaner. Apply the cleaner sparingly with soft cloths, and rub with moderate pressure until all dirt, oil scum and bug stains are removed. Allow the cleaner to dry, then wipe it off with soft flannel cloths.

If a windshield cleaner is not available, the plastic can be cleaned with

soft cloths moistened with Stoddard solvent to remove oil and grease.

NOTE

Never use gasoline, benzine, alcohol, acetone, fire extinguisher or anti-ice fluid, lacquer thinner or glass cleaner to clean the plastic. These materials will attack the plastic and may cause it to craze.

Follow by **carefully** washing with a mild detergent and plenty of water. Rinse thoroughly, then dry with a clean moist chamois. **Do not rub** the plastic with a dry cloth since this builds up an electrostatic charge which attracts dust. Waxing with a good commercial wax will finish the cleaning job. A thin, even coat of wax, polished out by hand with clean soft flannel cloths, will fill in minor scratches and help prevent further scratching.

Do not use a canvas cover on the windshield unless freezing rain or sleet is anticipated since the cover may scratch the plastic surface.

PAINTED SURFACES

The painted exterior surfaces of your new Cessna have a durable, long lasting finish and, under normal conditions, require no polishing or buffing. Approximately 10 days are required for the paint to cure completely; in most cases, the curing period will have been completed prior to delivery of the airplane. In the event that polishing or buffing is required within the curing period, it is recommended that the work be done by someone experienced in handling uncured paint. Any Cessna Dealer can accomplish this work.

Generally, the painted surfaces can be kept bright by washing with water and mild soap, followed by a rinse with water and drying with cloths or a chamois. Harsh or abrasive soaps or detergents which cause corrosion or scratches should never be used. Remove stubborn oil and grease with a cloth moistened with Stoddard solvent.

Waxing is unnecessary to keep the painted surfaces bright. However, if desired, the airplane may be waxed with a good automotive wax. A heavier coating of wax on the leading edges of the wings and tail and on the engine nose cap and propeller spinner will help reduce the abrasion encountered in these areas.

When the airplane is parked outside in cold climates and it is necessary to remove ice before flight, care should be taken to protect the painted surfaces during ice removal with chemical liquids. Isopropyl alcohol will satisfactorily remove ice accumulations without damaging the paint. However, keep the isopropyl alcohol from the windshield and cabin windows since it will attack the plastic and may cause it to craze.

STABILIZER ABRASION BOOT CARE

If the airplane is equipped with stabilizer abrasion boots, keep them clean and free from oil and grease which can swell the rubber. Wash them with mild soap and water, using Form Tech AC cleaner or naphtha to remove stubborn grease. Do not scrub the boots, and be sure to wipe off all solvent before it dries. Boots with loosened edges or small tears should be repaired. Your Cessna Dealer has the proper materials and know-how to do this correctly.

PROPELLER CARE

Preflight inspection of propeller blades for nicks, and wiping them occasionally with an oily cloth to clean off grass and bug stains will assure long, trouble-free service. Small nicks on the propeller, particularly near the tips and on the leading edges, should be dressed out as soon as possible since these nicks produce stress concentrations, and if ignored, may result in cracks. Never use an alkaline cleaner on the blades; remove grease and dirt with Stoddard solvent.

ENGINE CARE

The engine may be cleaned with Stoddard solvent, or equivalent, then dried thoroughly.

CAUTION

Particular care should be given to electrical equipment before cleaning. Cleaning fluids should not be allowed to enter magnetos, starter, alternator and the like. Protect these components before saturating the engine with solvents. All other openings should also be covered before cleaning the engine assembly. Caustic cleaning solutions should be used cautiously and should always be properly neutralized after their use.

INTERIOR CARE

To remove dust and loose dirt from the upholstery and carpet, clean the interior regularly with a vacuum cleaner.

Blot up any spilled liquid promptly with cleansing tissue or rags. Don't pat the spot; press the blotting material firmly and hold it for several seconds. Continue blotting until no more liquid is taken up. Scrape off sticky materials with a dull knife, then spot-clean the area.

Oily spots may be cleaned with household spot removers, used sparingly. Before using any solvent, read the instructions on the container

**SECTION 8
HANDLING, SERVICING
& MAINTENANCE**

**CESSNA
MODEL 172P**

and test it on an obscure place on the fabric to be cleaned. Never saturate the fabric with a volatile solvent; it may damage the padding and backing materials.

Soiled upholstery and carpet may be cleaned with foam-type detergent, used according to the manufacturer's instructions. To minimize wetting the fabric, keep the foam as dry as possible and remove it with a vacuum cleaner.

If your airplane is equipped with leather seating, cleaning of the seats is accomplished using a soft cloth or sponge dipped in mild soap suds. The soap suds, used sparingly, will remove traces of dirt and grease. The soap should be removed with a clean damp cloth.

The plastic trim, headliner, instrument panel and control knobs need only be wiped off with a damp cloth. Oil and grease on the control wheel and control knobs can be removed with a cloth moistened with Stoddard solvent. Volatile solvents, such as mentioned in paragraphs on care of the windshield, must never be used since they soften and craze the plastic.

BULB REPLACEMENT DURING FLIGHT

Figure 8-2 provides instructions to aid the pilot in the replacement of defective light bulbs during flight without tools. It is suggested that spare bulbs be stored in the map compartment. For a listing of other bulb requirements and specific tools needed, refer to the Service Manual for this airplane.

DOORPOST MOUNTED MAP LIGHT

Remove lens retainer by pulling straight out from housing. To remove either bulb, push forward and turn counterclockwise as far as possible, then pull bulb straight out of socket. Replace with S2243-1 clear, or S2243-2 red bulb as required. To install new bulb in socket, align pins on bulb with slots in socket, then push forward and rotate bulb clockwise as far as possible. Push lens retainer straight on housing until dimples on retainer seat into holes in housing.

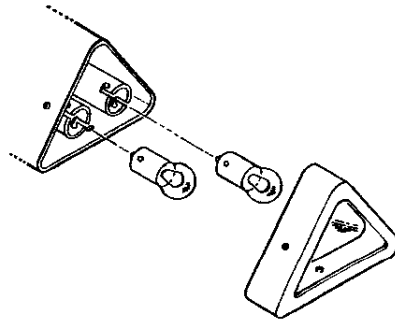

POST LIGHTS

Grasp lens cap and pull straight out from socket. Pull bulb from cap and replace with MS25237-327 bulb. Replace cap in socket and rotate cap to direct light in desired direction.

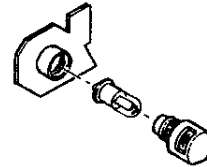

Figure 8-2. Bulb Replacement

SECTION 9 SUPPLEMENTS

(Optional Systems Description & Operating Procedures)

TABLE OF CONTENTS

Introduction

Major Configuration Variations:

1	Floatplane	(42 pages)
General:		
2	Air Conditioning System	(6 pages)
3	Carburetor Air Temperature Gage	(2 pages)
4	Circulation Fan System	(4 pages)
5	Digital Clock	(4 pages)
6	Ground Service Plug Receptacle	(4 pages)
7	Strobe Light System	(2 pages)
8	Winterization Kit	(2 pages)
Avionics:		
9	Audio Control Panels	(8 pages)
10	DME (Type 450C)	(4 pages)
11	Emergency Locator Transmitter (ELT)	(4 pages)
12	RNAV (Type ANS-351C)	(14 pages)
13	SSB HF Transceiver (Type ASB-125)	(4 pages)
14	200A Navomatic Autopilot (Type AF-295B)	(6 pages)
15	300 ADF (Type R-546E)	(6 pages)
16	300 Nav/Com (Type RT-385A)	(8 pages)
17	300 Transponder (Type RT-359A) And Optional Altitude Encoder (Blind)	(6 pages)
18	300 Transponder (Type RT-359A) And Optional Encoding Altimeter (Type EA-401A)	(6 pages)
19	300A Navomatic Autopilot (Type AF-395A)	(8 pages)
20	400 Glide Slope (Type R-443B)	(4 pages)
21	400 Marker Beacon (Type R-402A)	(6 pages)
22	400 Transponder (Type RT-459A) And Optional Altitude Encoder (Blind)	(6 pages)

TABLE OF CONTENTS (Continued)

**23 400 Transponder (Type RT-459A) And Optional
Encoding Altimeter (Type EA-401A) (6 pages)**

INTRODUCTION

This section consists of a series of supplements, each covering a single optional system which may be installed in the airplane. Each supplement contains a brief description, and when applicable, operating limitations, emergency and normal procedures, and performance. As listed in the Table of Contents, the supplements are classified under the headings of Major Configuration Variations, General and Avionics, and have been provided with reference numbers. Also, the supplements are arranged alphabetically and numerically to make it easier to locate a particular supplement. Other routinely installed items of optional equipment, whose function and operational procedures do not require detailed instructions, are discussed in Section 7.

Limitations contained in the following supplements are FAA approved. Observance of these operating limitations is required by Federal Aviation Regulations.

SUPPLEMENT

FLOATPLANE

SECTION 1

GENERAL

INTRODUCTION

This supplement, written especially for operators of the Cessna Skyhawk floatplane, provides information not found in the basic handbook. It contains procedures and data required for safe and efficient operation of the airplane equipped with Edo Model 89-2000 floats.

Information contained in the basic handbook for the Skyhawk, which is the same as that for the floatplane, is generally not repeated in this supplement.

PERFORMANCE - SPECIFICATIONS

SPEED:	
Maximum at Sea Level	96 KNOTS
Cruise, 75% Power at 4000 Ft	95 KNOTS
CRUISE: Recommended lean mixture with fuel allowance for engine start, taxi, takeoff, climb and 45 minutes reserve.	
75% Power at 4000 Ft	Range 360 NM
40 Gallons Usable Fuel	Time 3.8 HRS
75% Power at 4000 Ft	Range 475 NM
50 Gallons Usable Fuel	Time 5.0 HRS
Maximum Range at 10,000 Ft	Range 435 NM
40 Gallons Usable Fuel	Time 5.6 HRS
Maximum Range at 10,000 Ft	Range 565 NM
50 Gallons Usable Fuel	Time 7.3 HRS
RATE OF CLIMB AT SEA LEVEL	740 FPM
SERVICE CEILING	15,000 FT
TAKEOFF PERFORMANCE:	
Water Run	1400 FT
Total Distance Over 50-Ft Obstacle	2160 FT
LANDING PERFORMANCE:	
Water Run	590 FT
Total Distance Over 50-Ft Obstacle	1345 FT
STALL SPEED (KCAS):	
Flaps Up, Power Off	48 KNOTS
Flaps Down, Power Off	44 KNOTS
MAXIMUM WEIGHT:	
Ramp (Dock)	2227 LBS
Takeoff or Landing	2220 LBS
STANDARD EMPTY WEIGHT:	
Skyhawk Floatplane	1606 LBS
Skyhawk II Floatplane	1632 LBS
MAXIMUM USEFUL LOAD:	
Skyhawk Floatplane	621 LBS
Skyhawk II Floatplane	595 LBS
BAGGAGE ALLOWANCE	
WING LOADING: Pounds/Sq Ft	
POWER LOADING: Pounds/HP	
FUEL CAPACITY: Total	
Standard Tanks	43 GAL.
Long Range Tanks	54 GAL.
OIL CAPACITY	
ENGINE: Avco Lycoming	
160 BHP at 2700 RPM	
PROPELLER: Fixed Pitch, Diameter	
80 IN.	

The above performance figures are based on the indicated weights, standard atmospheric conditions, and no wind. They are calculated values derived from flight tests conducted by the Cessna Aircraft Company under carefully documented conditions and will vary with individual airplanes and numerous factors affecting flight performance.

DESCRIPTIVE DATA

PROPELLER

Propeller Manufacturer: McCauley Accessory Division.
Propeller Model Number: 1A175/ETM8042.
Number of Blades: 2.
Propeller Diameter, Maximum: 80 inches.
Minimum: 78.5 inches.
Propeller Type: Fixed Pitch.

MAXIMUM CERTIFICATED WEIGHTS

Ramp (Dock): 2227 lbs.
Takeoff: 2220 lbs.
Landing: 2220 lbs.
Weight in Baggage Compartment:
Baggage Area 1 (or passenger on child's seat) - Station 82 to 108: 120
lbs. See note below.
Baggage Area 2 - Station 108 to 142: 50 lbs. See note below.

NOTE

The maximum combined weight capacity for baggage
areas 1 and 2 is 120 lbs.

STANDARD AIRPLANE WEIGHTS

Standard Empty Weight, Skyhawk Floatplane: 1606 lbs.
Skyhawk II Floatplane: 1632 lbs.
Maximum Useful Load, Skyhawk Floatplane: 621 lbs.
Skyhawk II Floatplane: 595 lbs.

SPECIFIC LOADINGS

Wing Loading: 12.7 lbs./sq. ft.
Power Loading: 13.9 lbs./hp.

1
FLOATPLANE
MODEL 172P

PILOT'S OPERATING HANDBOOK
SUPPLEMENT

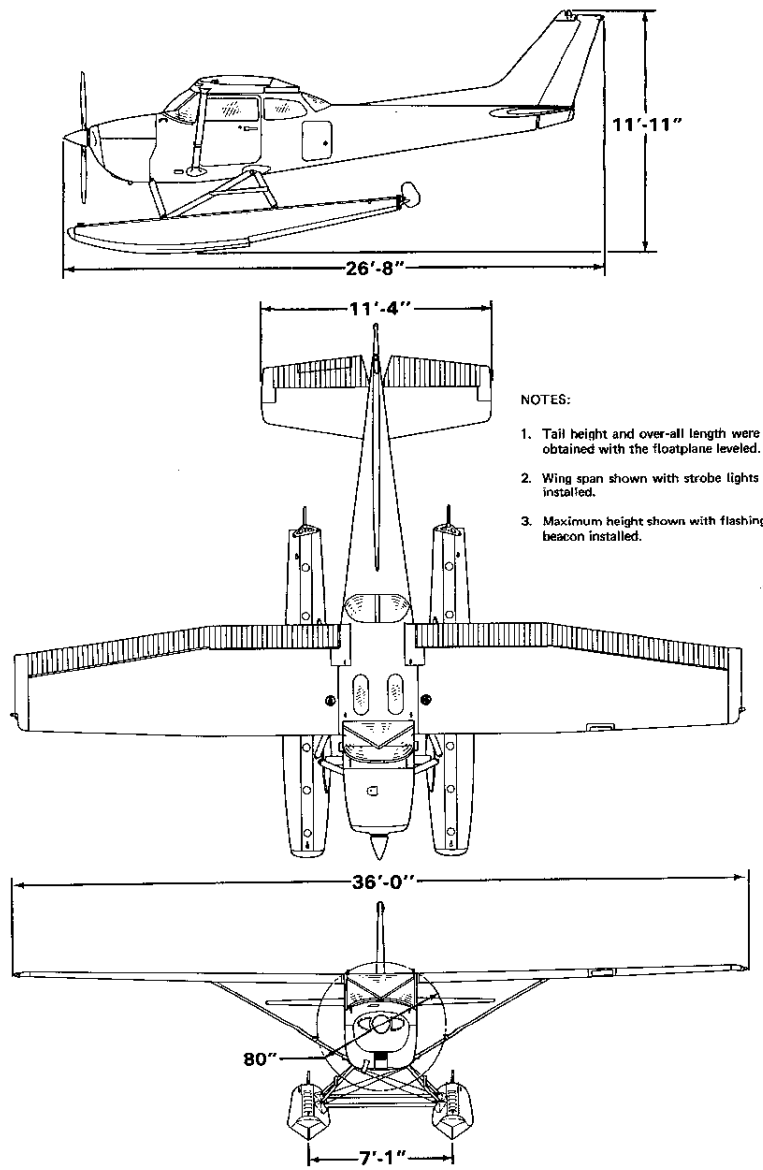

Figure 1. Three View

SECTION 2 LIMITATIONS

INTRODUCTION

Except as shown in this section, the floatplane operating limitations are the same as those for the Skyhawk landplane. The limitations in this section apply only to operations of the Model 172P equipped with Edo Model 89-2000 floats. The limitations included in this section have been approved by the Federal Aviation Administration. Observance of these operating limitations is required by Federal Aviation Regulations.

AIRSPPEED LIMITATIONS

Airspeed limitations and their operational significance are shown in figure 2.

	SPEED	KCAS	KIAS	REMARKS
V _{NE}	Never Exceed Speed	157	158	Do not exceed this speed in any operation.
V _{NO}	Maximum Structural Cruising Speed	126	127	Do not exceed this speed except in smooth air, and then only with caution.
V _A	Maneuvering Speed: 2220 Pounds 2020 Pounds 1820 Pounds	95 91 86	96 91 86	Do not make full or abrupt control movements above this speed.
V _{FE}	Maximum Flap Extended Speed 10° Flaps 10° - 30° Flaps	111 87	110 85	Do not exceed this speed with flaps down.

Figure 2. Airspeed Limitations

AIRSPPEED INDICATOR MARKINGS

Airspeed indicator markings are the same as those shown in the basic handbook. Due to minor differences in airspeed system calibration and stall speeds with floats installed, the indicated stall speeds as shown in Section 5 of this supplement are different than those reflected by the airspeed indicator markings.

POWER PLANT LIMITATIONS

Engine Operating Limits for Takeoff and Continuous Operations:
Maximum Engine Speed: 2700 RPM.

NOTE

The static RPM range at full throttle (carburetor heat off) is 2470 to 2570 RPM.

Propeller Manufacturer: McCauley Accessory Division.
Propeller Model Number: 1A175/ETM8042.
Propeller Diameter, Maximum: 80 inches.
Minimum: 78.5 inches.

WEIGHT LIMITS

Maximum Ramp (Dock) Weight: 2227 lbs.
Maximum Takeoff Weight: 2220 lbs.
Maximum Landing Weight: 2220 lbs.
Maximum Weight in Baggage Compartment:
Baggage Area 1 (or passenger on child's seat) - Station 82 to 108: 120 lbs. See note below.
Baggage Area 2 - Station 108 to 142: 50 lbs. See note below.

NOTE

The maximum combined weight capacity for baggage areas 1 and 2 is 120 lbs.

NOTE

When floats are installed, it is possible to exceed the maximum takeoff weight with all seats occupied and minimum fuel.

CENTER OF GRAVITY LIMITS

Center of Gravity Range:
Forward: 36.4 inches aft of datum at 1825 lbs. or less, with straight line variation to 39.8 inches aft of datum at 2220 lbs.
Aft 45.5 inches aft of datum at all weights.

Reference Datum: Lower portion of front face of firewall.

MANEUVER LIMITS

The floatplane is certificated in the normal category. The normal category is applicable to aircraft intended for non-aerobatic operations. These include any maneuvers incidental to normal flying, stalls (except whip stalls), lazy eights, chandelles, and steep turns in which the angle of bank is not more than 60°. Aerobatic maneuvers, including spins, are not approved.

FLIGHT LOAD FACTOR LIMITS

Flight Load Factors (Maximum Takeoff Weight - 2220 lbs.):

*Flaps Up	+3.8g, -1.52g
*Flaps Down	+3.0g

*The design load factors are 150% of the above, and in all cases, the structure meets or exceeds design loads.

OTHER LIMITATIONS

FLAP LIMITATIONS

Approved Takeoff Range: 0° to 10°.
Approved Landing Range: 0° to 30°.

WATER RUDDER LIMITATIONS

Water rudders must be retracted for all flight operations.

PLACARDS

The following information must be displayed in the form of composite or individual placards in addition to those specified in the basic handbook.

1. In full view of the pilot: (The "DAY-NIGHT-VFR-IFR" entry, shown on the example below, will vary as the airplane is equipped.)

The markings and placards installed in this airplane contain operating limitations which must be complied with when operating this airplane in the Normal Category. Other operating limitations which must be complied with when operating this airplane in this category are contained in the Pilot's Operating Handbook and FAA Approved Airplane Flight Manual.

No acrobatic maneuvers, including spins, approved.

Flight into known icing conditions prohibited.

This airplane is certified for the following flight operations as of date of original airworthiness certificate:

DAY-NIGHT-VFR-IFR

2. Near water rudder stowage hook:

WATER RUDDER ALWAYS UP
EXCEPT WATER TAXIING

3. In full view of the pilot:

WATER RUDDER MUST BE RETRACTED
FOR TAKEOFF, FLIGHT, AND LANDING.

4. Near the airspeed indicator:

MANEUVER SPEED - 96 KIAS.

Notes: _____

SECTION 3 EMERGENCY PROCEDURES

INTRODUCTION

Checklist and amplified procedures contained in the basic handbook generally should be followed. The additional or changed procedures specifically required for operation of the Model 172P equipped with Edo Model 89-2000 floats are presented in this section.

AIRSPEDS FOR EMERGENCY OPERATION

The speeds listed below should be substituted, as appropriate, for the speeds contained in Section 3 of the basic handbook.

Engine Failure After Takeoff:	
Wing Flaps Up	65 KIAS
Wing Flaps Down 10°	60 KIAS
Maneuvering Speed:	
2220 Lbs	96 KIAS
2020 Lbs	91 KIAS
1820 Lbs	86 KIAS
Maximum Glide	65 KIAS
Precautionary Landing With Engine Power, Flaps Down	60 KIAS
Landing Without Engine Power:	
Wing Flaps Up	65 KIAS
Wing Flaps Down	60 KIAS

OPERATIONAL CHECKLISTS

Procedures in the Operational Checklists portion of this section shown in **bold-faced** type are immediate-action items which should be committed to memory.

ENGINE FAILURE

ENGINE FAILURE DURING TAKEOFF RUN

1. **Throttle -- IDLE.**
2. **Control Wheel -- FULL AFT.**
3. Mixture -- IDLE CUT-OFF.
4. Ignition Switch -- OFF.
5. Master Switch -- OFF.

FORCED LANDINGS

EMERGENCY LANDING ON WATER WITHOUT ENGINE POWER

1. **Airspeed -- 65 KIAS (flaps UP).**
60 KIAS (flaps DOWN).
2. Mixture -- IDLE CUT-OFF.
3. Fuel Selector Valve -- OFF.
4. Ignition Switch -- OFF.
5. Water Rudders -- UP.
6. Wing Flaps -- AS REQUIRED.
7. Master Switch -- OFF.
8. Doors -- UNLATCH PRIOR TO APPROACH.
9. Touchdown -- SLIGHTLY TAIL LOW.
10. Control Wheel -- HOLD FULL AFT as floatplane decelerates.

EMERGENCY LANDING ON LAND WITHOUT ENGINE POWER

1. **Airspeed -- 65 KIAS (flaps UP).**
60 KIAS (flaps DOWN).
2. Mixture -- IDLE CUT-OFF.
3. Fuel Selector Valve -- OFF.
4. Ignition Switch -- OFF.
5. Water Rudders -- UP.
6. Wing Flaps -- AS REQUIRED (30° recommended).
7. Master Switch -- OFF.
8. Doors -- UNLATCH PRIOR TO APPROACH.
9. Touchdown -- LEVEL ATTITUDE.
10. Control Wheel -- FULL AFT (after contact).

AMPLIFIED PROCEDURES

MAXIMUM GLIDE

After an engine failure in flight, the best glide speed as shown in figure 3 should be established as quickly as possible. In the likely event the propeller should stop, maintain the speed shown.

*** PROPELLER WINDMILLING**

*** SPEED 65 KIAS**

*** ZERO WIND**

*** FLAPS UP**

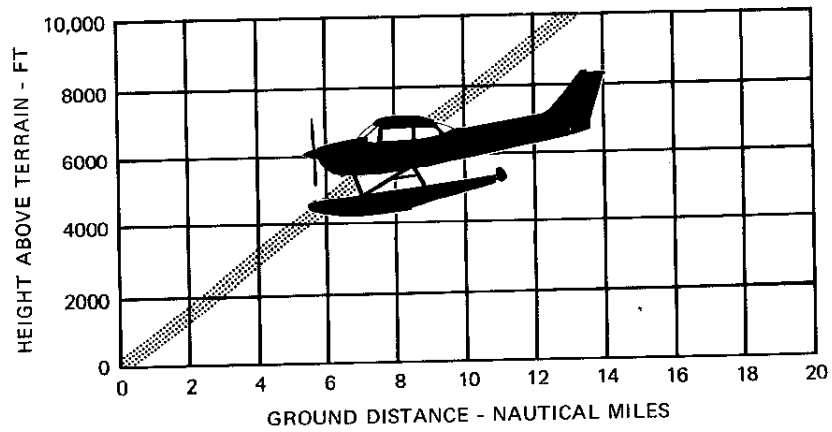

Figure 3. Maximum Glide

Notes: _____

SECTION 4 NORMAL PROCEDURES

INTRODUCTION

Checklist and amplified procedures contained in the basic handbook generally should be followed. The additional or changed procedures specifically required for operation of the Model 172P equipped with Edo Model 89-2000 floats are presented in this section.

SPEEDS FOR NORMAL OPERATION

Unless otherwise noted, the following speeds are based on a maximum weight of 2220 pounds and may be used for any lesser weight.

Takeoff:	
Normal Climb Out	65 KIAS
Maximum Performance, Flaps 10°, Speed at 50 Feet	53 KIAS
Enroute Climb, Flaps Up:	
Normal	60-70 KIAS
Best Rate of Climb, Sea Level	64 KIAS
Best Rate of Climb, 10,000 Feet	57 KIAS
Best Angle of Climb, Sea Level thru 10,000 Feet	53 KIAS
Landing Approach:	
Normal Approach, Flaps Up	60-70 KIAS
Normal Approach, Flaps 30°	55-65 KIAS
Maximum Performance Approach, Flaps 30°	53 KIAS
Balked Landing:	
Maximum Power, Flaps 20°	55 KIAS
Maximum Recommended Turbulent Air Penetration Speed:	
2220 Lbs	96 KIAS
2020 Lbs	91 KIAS
1820 Lbs	86 KIAS
Maximum Demonstrated Crosswind Velocity:	
Takeoff or Landing	10 KNOTS

CHECKLIST PROCEDURES

PREFLIGHT INSPECTION

1. Pilot's Operating Handbook and Floatplane Supplement -- AVAILABLE IN THE AIRPLANE.
2. Floats, Struts, and Float Fairings -- INSPECT for dents, cracks, scratches, etc.
3. Float Compartments -- INSPECT for water accumulation.

NOTE

Remove rubber balls which serve as stoppers on the standpipe in each float compartment and pump out any accumulation of water. Reinstall rubber balls with enough pressure for a snug fit.

3. Water Rudders -- CHECK freedom of movement and security.

BEFORE STARTING ENGINE

1. Water Rudder Operation -- CHECK VISUALLY.
2. Water Rudders -- DOWN for taxiing (retraction handle removed from stowage hook).

TAKEOFF

1. Water Rudders -- UP (retraction handle secured on stowage hook).
2. Wing Flaps -- 0° - 10° (10° preferred).
3. Carburetor Heat -- COLD.
4. Control Wheel -- HOLD FULL AFT.
5. Throttle -- FULL (advance slowly).
6. Mixture -- RICH (or LEAN to obtain maximum RPM above 3000 feet).
7. Control Wheel -- MOVE FORWARD when the nose stops rising to attain planing attitude (on the step).
8. Airspeed -- 45-50 KIAS.
9. Control Wheel -- APPLY LIGHT BACK PRESSURE to lift off.

NOTE

To reduce takeoff water run, the technique of raising one float out of the water may be used. This procedure is described in the amplified procedures in this section.

10. Climb Speed -- 55-65 KIAS (flaps 10°).
60-70 KIAS (flaps UP).
With obstacles ahead, climb at 53 KIAS (flaps 10°).
11. Wing Flaps -- UP after all obstacles are cleared.

ENROUTE CLIMB

NORMAL CLIMB

1. Airspeed -- 60-70 KIAS.

MAXIMUM PERFORMANCE CLIMB

1. Airspeed -- 64 KIAS (sea level) to 57 KIAS (10,000 feet).

BEFORE LANDING

1. Water Rudders -- UP.
2. Wing Flaps -- AS DESIRED.
3. Airspeed -- 60-70 KIAS (flaps UP).
55-65 KIAS (flaps DOWN).

LANDING

1. Touchdown -- SLIGHTLY TAIL LOW.
2. Control Wheel -- HOLD FULL AFT as floatplane decelerates to taxi speed.

NOTE

With forward loading, a slight nose-down pitch may occur if the elevator is not held full up as floatplane comes down off step.

AFTER LANDING

1. Water Rudders -- DOWN.

SECURING AIRPLANE

1. Fuel Selector Valve -- LEFT TANK or RIGHT TANK to minimize cross-feeding and ensure maximum fuel capacity when refueling.

AMPLIFIED PROCEDURES

TAXIING

Taxi with water rudders down. It is best to limit the engine speed to 800 RPM for normal taxi because water piles up in front of the float bow at higher engine speeds. Taxiing with higher engine RPM may result in engine overheating and will not appreciably increase the taxi speed. In addition, it may lead to water spray striking the propeller tips, causing propeller tip erosion.

During all low speed taxi operations, the elevator should be positioned to keep the float bows out of the water as far as possible. Normally this requires holding the control wheel full aft.

For minimum taxi speed in close quarters, use idle RPM with full carburetor heat and a single magneto. This procedure is recommended for short periods of time only.

Although taxiing is very simple with the water rudders, it is sometimes necessary to "sail" the floatplane under high wind conditions. In addition to the normal flight controls, the wing flaps and cabin doors will aid in "sailing". Water rudders should be retracted during "sailing".

To taxi great distances, it may be advisable to taxi on the step with the water rudders retracted. Turns on the step from an upwind heading may be made with safety providing they are not too sharp and if ailerons are used to counteract any overturning tendency.

TAKEOFF

Start the takeoff by applying full throttle smoothly while holding the control wheel full aft. When the nose stops rising, move the control wheel forward slowly to place the floatplane on the step. Slow control movement and light control pressures produce the best results. Attempts to force the floatplane into the planing attitude will generally result in loss of speed and delay in getting on the step. The floatplane will assume a planing attitude which permits acceleration to takeoff speed, at which time the floatplane will fly off smoothly.

The use of 10° wing flaps throughout the takeoff run is recommended. Upon reaching a safe altitude and airspeed, retract the wing flaps slowly, especially when flying over glassy water because a loss of altitude is not very apparent over such a surface.

If porpoising is encountered while on the step, apply additional control wheel back pressure to correct the excessively nose-low attitude. If this does not correct the porpoising, immediately reduce power to idle and allow the floatplane to slow to taxi speed, at which time the takeoff can again be initiated.

MAXIMUM PERFORMANCE TAKEOFF

To clear an obstacle after takeoff with 10° wing flaps, use an obstacle clearance speed of 53 KIAS for maximum performance. Takeoff distances are shown in Section 5 for this technique, and on water conditions that are smooth but non-glassy. Under some adverse combinations of takeoff weight, pressure altitude, and air temperature, operation on glassy water may require significantly longer takeoff distances to accelerate to the liftoff speed, and allowance should be made for this.

If liftoff is difficult due to high lake elevation or glassy water, the following procedure is recommended: With the floatplane in the planing attitude, apply full aileron to raise one float out of the water. When one float leaves the water, apply slight elevator back pressure to complete the takeoff. Care must be taken to stop the rising wing as soon as the float is clear of the water, and in crosswinds, raise only the downwind wing. With one float out of the water, the floatplane accelerates to takeoff speed almost instantaneously.

CROSSWIND TAKEOFF

For a crosswind takeoff, start the takeoff run with wing flaps up, ailerons deflected partially into the wind and water rudders extended for better directional control. Flaps should be extended to 10° and the water rudders retracted when the floatplane is on the step; the remainder of the takeoff is normal. If the floats are lifted from the water one at a time, the downwind float should be lifted first.

ENROUTE CLIMB

Recommended procedures for enroute climb are the same as for the landplane. For maximum rate of climb performance refer to figure 8 of this supplement.

CRUISE

Cruise power settings and corresponding fuel consumption are shown on the Cruise Performance chart, figure 9 in this supplement. Range and endurance information is shown in figures 10 and 11 in this supplement.

It should be noted that the tachometer stepped green arc markings representing 75% power at sea level, 5000 feet and 10,000 feet are based on the landplane. Refer to the cruise tables in Section 5 for percent power information applicable to the floatplane.

LANDING

Normal landings can be made power on or power off using approach speeds of 60-70 KIAS with flaps up and 55-65 KIAS with flaps down.

GLASSY WATER LANDING

With glassy water conditions, flaps should be extended to 20° and enough power used to maintain a low rate of descent (approximately 200 feet per minute). The floatplane should be flown onto the water at this sink rate with no flare attempted since height above glassy water is nearly impossible to judge. Power should be reduced to idle and control wheel back pressure increased upon contacting the surface. As the floatplane decelerates off the step, apply full back pressure on the control wheel. If this glassy water technique is used in conjunction with an obstacle clearance approach, allowance should be made for appreciably longer total distances than are shown in Section 5 to clear a 50-foot obstacle.

CROSSWIND LANDING

The wing-low slip method should be used with the upwind float contacting the surface first.

NOISE CHARACTERISTICS

The certificated noise level for the Model 172P Floatplane at 2220 pounds maximum weight is 72.2 dB(A). No determination has been made by the Federal Aviation Administration that the noise levels of this airplane are or should be acceptable or unacceptable for operation at, into, or out of, any landing area.

SECTION 5 PERFORMANCE

INTRODUCTION

The information presented in the Introduction, Use of Performance Charts, and Sample Problem paragraphs in Section 5 of the basic handbook is applicable to the floatplane. Using this information, and the performance charts in this supplement, complete flight planning may be accomplished.

DEMONSTRATED OPERATING TEMPERATURE

Satisfactory engine cooling has been demonstrated for this floatplane with an outside air temperature 23°C above standard. This is not to be considered as an operating limitation. Reference should be made to Section 2 for engine operating limitations.

AIRSPEED CALIBRATION NORMAL STATIC SOURCE

CONDITION:
Power required for level flight or maximum rated RPM dive.

FLAPS UP																
KIAS	40	50	60	70	80	90	100	110	120	130	140	150	160			
KCAS	47	54	62	71	80	90	99	109	119	129	139	149	159			
FLAPS 10°																
KIAS	40	50	60	70	80	90	100	110	---	---	---	---	---	---		
KCAS	46	53	62	72	82	91	101	111	---	---	---	---	---	---		
FLAPS 30°																
KIAS	40	50	60	70	80	85	---	---	---	---	---	---	---	---		
KCAS	45	52	62	72	82	87	---	---	---	---	---	---	---	---		

Figure 4. Airspeed Calibration

STALL SPEEDS

CONDITIONS:
 Power Off

NOTES:

1. Altitude loss during a stall recovery may be as much as 200 feet.
2. KIAS values are approximate.

MOST REARWARD CENTER OF GRAVITY

WEIGHT LBS	FLAP DEFLECTION	ANGLE OF BANK							
		0°		30°		45°		60°	
		KIAS	KCAS	KIAS	KCAS	KIAS	KCAS	KIAS	KCAS
2220	UP	38	48	41	52	46	57	55	68
	10°	35	46	38	49	42	55	50	65
	30°	36	44	39	47	44	52	53	62

MOST FORWARD CENTER OF GRAVITY

WEIGHT LBS	FLAP DEFLECTION	ANGLE OF BANK							
		0°		30°		45°		60°	
		KIAS	KCAS	KIAS	KCAS	KIAS	KCAS	KIAS	KCAS
2220	UP	41	50	44	54	49	59	58	71
	10°	37	47	40	51	45	56	54	66
	30°	36	44	39	47	44	52	53	62

Figure 5. Stall Speeds

TAKEOFF DISTANCE
MAXIMUM PERFORMANCE

CONDITIONS:
Flaps 10°
Full Throttle
Zero Wind

NOTE:
Decrease distances 10% for each 9 knots headwind.

WEIGHT LBS	TAKEOFF SPEED KIAS		PRESS ALT FT	0°C		10°C		20°C		30°C		40°C	
	LIFT OFF	AT 50 FT		WATER RUN	TO CLEAR 50 FT OBS	WATER RUN	TO CLEAR 50 FT OBS	WATER RUN	TO CLEAR 50 FT OBS	WATER RUN	TO CLEAR 50 FT OBS	WATER RUN	TO CLEAR 50 FT OBS
2220	47	53	S.L.	1185	1870	1325	2060	1480	2270	1660	2505	1870	2780
			1000	1380	1550	2365	1750	2625	1975	2920	2245	3265	
			2000	1625	1840	2750	2095	3075	2395	3455	2750	3905	
			3000	1945	2225	3245	2555	3665	2960	4165	3460	4770	
			4000	2365	3430	2735	3900	3195	4460	3775	4520	6015	

Figure 6. Takeoff Distance

MAXIMUM RATE OF CLIMB

CONDITIONS:
 Flaps Up
 Full Throttle

NOTE:
 Mixture leaned above 3000 feet for maximum RPM.

WEIGHT LBS	PRESS ALT FT	CLIMB SPEED KIAS	RATE OF CLIMB - FPM		
			0°C	20°C	40°C
2220	S.L.	64	790	725	655
	2000	62	690	625	560
	4000	61	590	530	465
	6000	60	495	435	375
	8000	59	395	340	---
	10,000	57	300	245	---

Figure 7. Maximum Rate of Climb

TIME, FUEL, AND DISTANCE TO CLIMB

MAXIMUM RATE OF CLIMB

CONDITIONS:
Flaps Up
Full Throttle
Standard Temperature

- NOTES:
1. Add 1.1 gallons of fuel for engine start, taxi and takeoff allowance.
 2. Mixture leaned above 3000 feet for maximum RPM.
 3. Increase time, fuel and distance by 10% for each 10°C above standard temperature.
 4. Distances shown are based on zero wind.

WEIGHT LBS	PRESSURE ALTITUDE FT	TEMP °C	CLIMB SPEED KIAS	RATE OF CLIMB FPM	FROM SEA LEVEL		
					TIME MIN	FUEL USED GALLONS	DISTANCE NM
2220	S.L.	15	64	740	0	0	0
	1000	13	63	695	1	0.3	2
	2000	11	62	655	3	0.7	3
	3000	9	62	610	4	1.0	5
	4000	7	61	570	6	1.4	7
	5000	5	61	525	8	1.7	9
	6000	3	60	485	10	2.1	11
	7000	1	59	440	12	2.5	14
	8000	-1	59	400	15	3.0	16
	9000	-3	58	355	17	3.4	20
	10,000	-5	57	315	20	3.9	23

Figure 8. Time, Fuel, and Distance to Climb

CRUISE PERFORMANCE

CONDITIONS:
 2220 Pounds
 Recommended Lean Mixture

PRESSURE ALTITUDE FT	RPM	20°C BELOW STANDARD TEMP			STANDARD TEMPERATURE			20°C ABOVE STANDARD TEMP		
		% BHP	KTAS	GPH	% BHP	KTAS	GPH	% BHP	KTAS	GPH
2000	2650	---	---	---	75	94	8.5	71	93	7.9
	2600	77	92	8.6	71	92	8.0	67	91	7.5
	2500	68	88	7.6	64	87	7.2	61	86	6.8
	2400	61	84	6.8	57	82	6.5	54	80	6.2
	2300	55	79	6.2	51	77	5.9	49	74	5.7
4000	2700	---	---	---	75	95	8.4	71	95	7.9
	2600	72	92	8.1	68	91	7.6	64	90	7.2
	2500	65	88	7.3	61	86	6.8	58	85	6.5
	2400	58	83	6.5	55	81	6.2	52	78	5.9
	2300	52	77	6.0	49	75	5.7	46	72	5.5
6000	2700	76	95	8.6	71	95	8.0	67	94	7.5
	2600	69	91	7.7	64	90	7.2	61	88	6.8
	2500	62	87	6.9	58	85	6.5	55	82	6.2
	2400	56	81	6.3	52	79	6.0	49	76	5.7
8000	2700	72	95	8.1	68	94	7.6	64	92	7.2
	2600	65	90	7.3	61	89	6.9	58	86	6.5
	2500	59	85	6.6	55	83	6.2	52	80	6.0
	2400	53	79	6.0	50	77	5.8	47	73	5.5
10,000	2700	69	94	7.7	64	92	7.2	61	90	6.8
	2600	62	89	6.9	58	87	6.5	55	84	6.2
	2500	56	83	6.3	53	81	6.0	49	77	5.8

Figure 9. Cruise Performance

RANGE PROFILE 45 MINUTES RESERVE 40 GALLONS USABLE FUEL

CONDITIONS:
2220 Pounds
Recommended Lean Mixture for Cruise
Standard Temperature
Zero Wind

NOTE:
This chart allows for the fuel used for engine start, taxi, takeoff and climb, and the distance during climb.

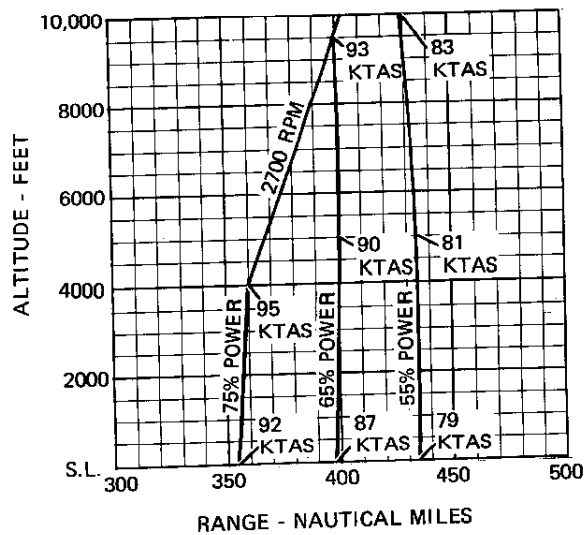

Figure 10. Range Profile (Sheet 1 of 2)

RANGE PROFILE 45 MINUTES RESERVE 50 GALLONS USABLE FUEL

CONDITIONS:
2220 Pounds
Recommended Lean Mixture for Cruise
Standard Temperature
Zero Wind

NOTE:
This chart allows for the fuel used for engine start, taxi, takeoff and climb, and the distance during climb.

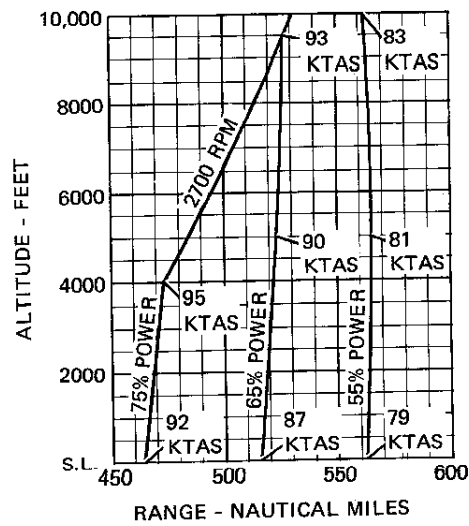

Figure 10. Range Profile (Sheet 2 of 2)

ENDURANCE PROFILE 45 MINUTES RESERVE 40 GALLONS USABLE FUEL

CONDITIONS:
2220 Pounds
Recommended Lean Mixture for Cruise
Standard Temperature

NOTE:
This chart allows for the fuel used for engine start, taxi, takeoff and climb, and the time during climb.

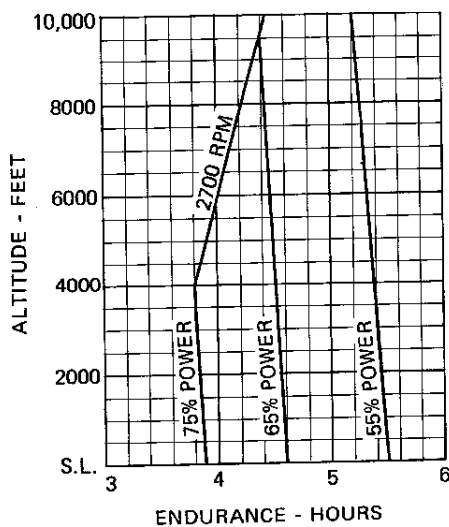

Figure 11. Endurance Profile (Sheet 1 of 2)

ENDURANCE PROFILE
45 MINUTES RESERVE
50 GALLONS USABLE FUEL

CONDITIONS:
2220 Pounds
Recommended Lean Mixture for Cruise
Standard Temperature

NOTE:
This chart allows for the fuel used for engine start, taxi, takeoff and climb, and the time during climb.

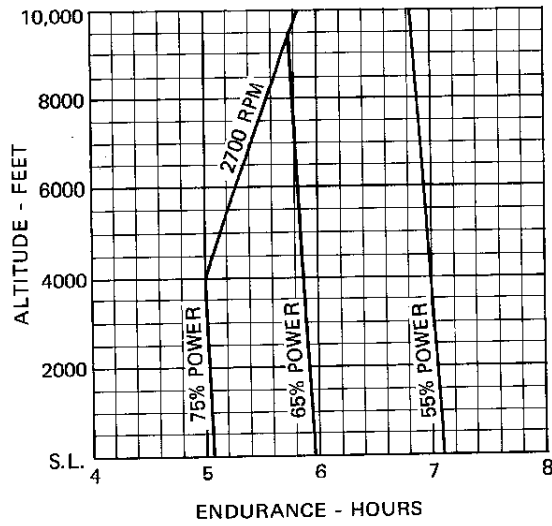

Figure 11. Endurance Profile (Sheet 2 of 2)

LANDING DISTANCE
MAXIMUM PERFORMANCE

CONDITIONS:
Flaps 30°
Power Off
Zero Wind

NOTES:

1. Refer to Section 4 for recommended technique if water surface is glassy.
2. Decrease distances 10% for each 9 knots headwind.
3. If a landing with flaps up is necessary, increase the approach speed by 6 KIAS and allow for 30% longer distances.

WEIGHT LBS	SPEED AT 50 FT KIAS	PRESS ALT FT	0°C		10°C		20°C		30°C		40°C	
			WATER RUN	TOTAL TO CLEAR 50 FT OBS	WATER RUN	TOTAL TO CLEAR 50 FT OBS	WATER RUN	TOTAL TO CLEAR 50 FT OBS	WATER RUN	TOTAL TO CLEAR 50 FT OBS	WATER RUN	TOTAL TO CLEAR 50 FT OBS
2220	53	S.L.	560	1300	580	1330	600	1360	620	1390	640	1420
		1000	580	1330	600	1360	620	1390	645	1425	665	1455
		2000	600	1360	625	1395	645	1430	670	1465	690	1495
		3000	625	1395	645	1430	670	1465	695	1500	715	1530
		4000	650	1435	670	1465	695	1500	720	740	1570	

Figure 12. Landing Distance

SECTION 6 WEIGHT & BALANCE

INTRODUCTION

Weight and balance information contained in the basic handbook generally should be used, and will enable you to operate the floatplane within the prescribed weight and center of gravity limitations. The changed information specifically required for operation of the Model 172P equipped with Edo Model 89-2000 floats is presented in this section.

NOTE

When floats are installed, it is possible to exceed the maximum takeoff weight with all seats occupied and minimum fuel.

It is the responsibility of the pilot to ensure that the floatplane is loaded properly.

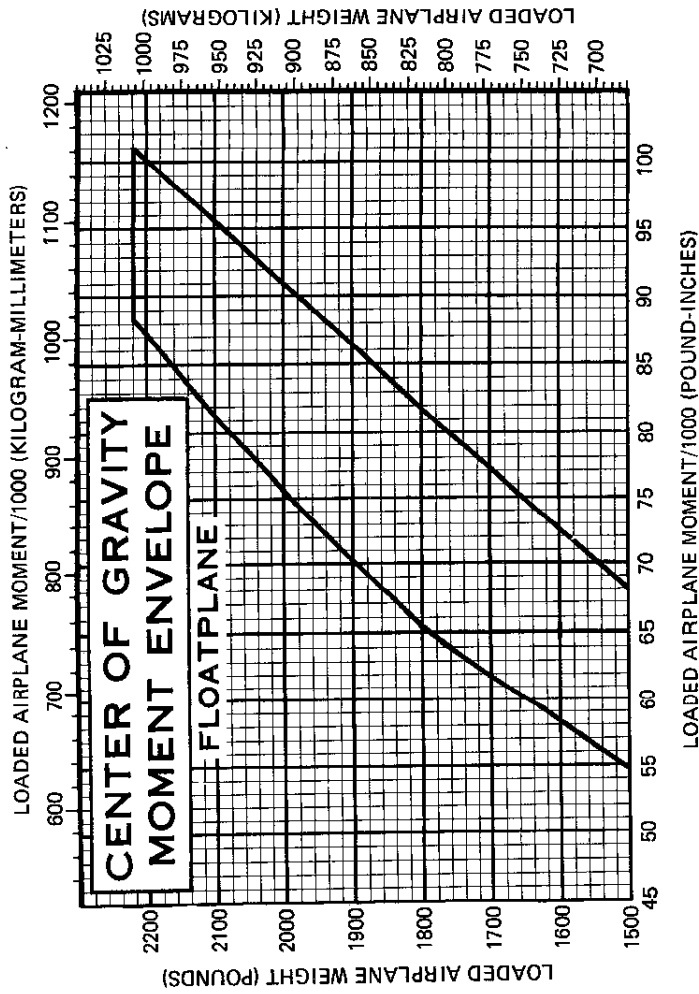

Figure 13. Center of Gravity Moment Envelope

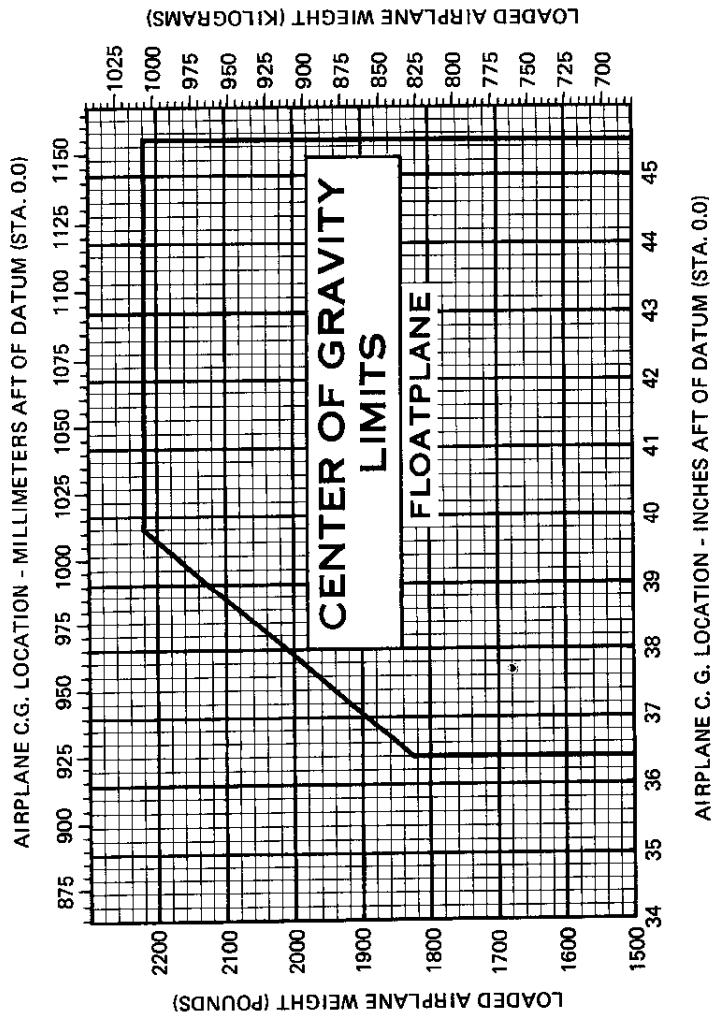

Figure 14. Center of Gravity Limits

SECTION 7 AIRPLANE & SYSTEMS DESCRIPTIONS

INTRODUCTION

This section contains a description of the modifications and equipment associated specifically with the installation of Edo Model 89-2000 floats on the Model 172P.

THE FLOATPLANE

The floatplane is identical to the landplane with the following exceptions:

1. Floats, incorporating a water rudder steering system, replace the landing gear. A water rudder retraction handle, connected to the dual water rudders by cables and springs, is located on the cabin floor.
2. Additional fuselage structure is added to support the float installation.
3. An additional structural "V" brace is installed between the top of the front door posts and the cowl deck.
4. The airplane has additional corrosion-proofing and stainless steel cables.
5. Interconnect springs are added between the rudder and aileron control systems.
6. The fuel strainer installation is modified for floatplane use.
7. The standard propeller is replaced with a propeller of larger diameter (80 inches) and flatter pitch.
8. A lower cowl with a larger cooling air exit for better engine cooling replaces the standard lower cowl.
9. Hoisting provisions are added to the top of the fuselage.
10. Fueling steps and assist handles are mounted on the forward fuselage, and steps are mounted on the wing struts to aid in refueling the airplane.
11. Floatplane placards are added.

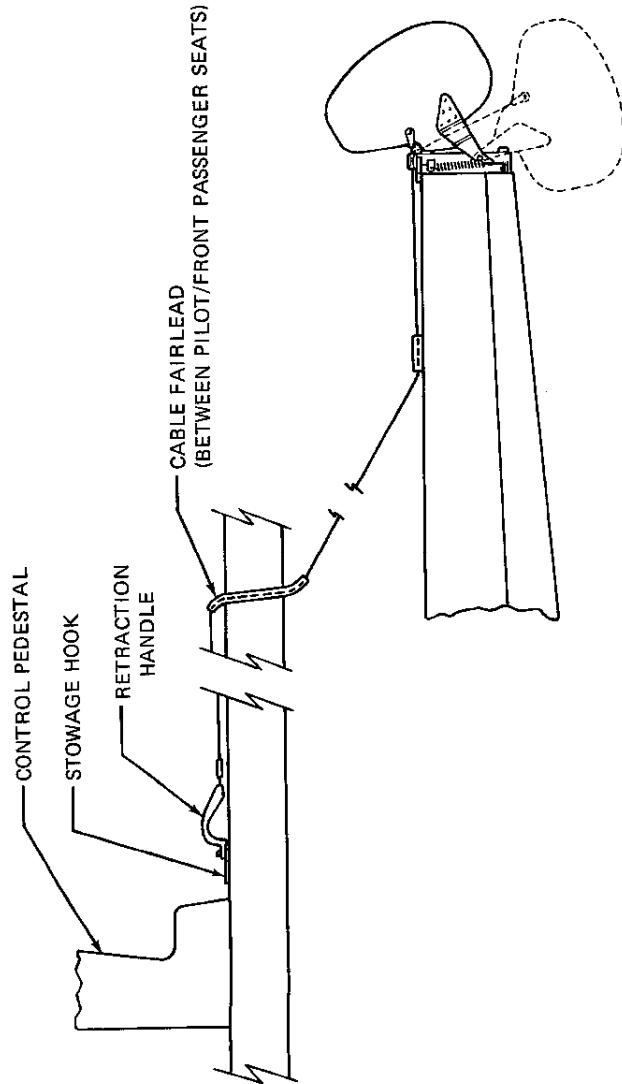

Figure 15. Water Rudder Retraction System

WATER RUDDER SYSTEM

Retractable water rudders (figure 15), mounted at the aft end of each float, are connected by a system of cables and springs to the rudder pedals. Normal rudder pedal operation moves the water rudders to provide steering control (figure 16) for taxiing.

The water rudders are equipped with centering cams (attached to each retraction hinge) which, when the water rudders are retracted, make contact with a plate on the stern of each float, locking the rudders in the centered position. Springs within the water rudder steering system permit normal airplane rudder action with the water rudders retracted and improve directional stability in flight.

A water rudder retraction handle, located on the cabin floor between the front seats, is used to manually raise and lower the water rudders. During takeoff, landing, and in flight, the handle should be secured on the stowage hook located on the cabin floor just aft of the control pedestal. With the handle in this position, the water rudders are up. When the handle is removed from the hook and allowed to move full aft, the water rudders extend to the full down position for taxiing.

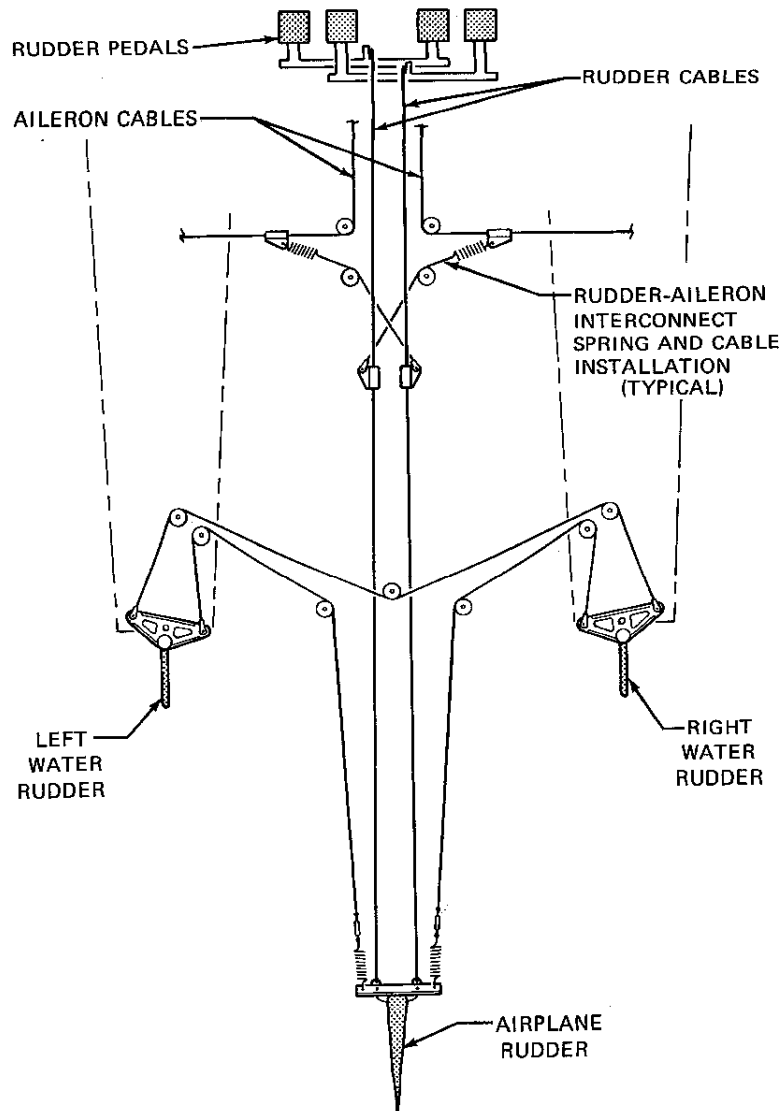

Figure 16. Water Rudder Steering System

SECTION 8

AIRPLANE HANDLING, SERVICE & MAINTENANCE

INTRODUCTION

Section 8 of the basic handbook applies, in general, to the floatplane. The following recommended procedures apply specifically to floatplane operation. (Cleaning and maintenance of the floats should be accomplished as suggested in the Edo Corporation Service and Maintenance Manual for Floats.)

MOORING

Proper securing of the floatplane can vary considerably, depending on the type of operation involved and the facilities available. Each operator should use the method most appropriate for his operation. Some of the most common mooring alternatives are as follows:

1. The floatplane can be moored to a buoy, using a yoke tied to the forward float cleats, so that it will freely weathervane into the wind.
2. The floatplane can be secured to a dock using the fore and aft cleats of one float, although this method is generally not recommended unless the water is calm and the floatplane is attended.
3. The floatplane may be removed from the water (by use of a special lift under the spreader bars) and secured by using the wing tie-down rings and float cleats. If conditions permit the floatplane to be beached, ensure that the shoreline is free of rocks or abrasive material that may damage the floats.

SUPPLEMENT

AIR CONDITIONING SYSTEM

SECTION 1 GENERAL

The air conditioning system provides a comfortable cabin temperature during ground and flight operations. System controls are located on the control pedestal and consist of two rotary type control knobs. Blower speed is controlled by the upper knob, labeled FAN. The control rotates clockwise from OFF through three positions labeled LOW, MED, and HI, and provides three blower speeds. Temperature is controlled by the lower knob, labeled AIR TEMP. Rotating the control clockwise from OFF to ON will start the compressor. Clockwise rotation from ON to MAX will control cabin temperature by cycling the compressor operation. System electrical protection is provided by a 10-amp circuit breaker, labeled AIR COND, on the left side of the switch and control panel. Cooling air is vented to the cabin through two ducts and four fully adjustable outlets above the cabin side windows.

System components (see figure 1) include a belt-driven compressor, two Schrader valves, high pressure switch, condenser, air scoop, receiver/drier, expansion valve, evaporator/blower unit and the necessary controls, plumbing and wiring. The belt-driven compressor is located at the front of the engine on the left side. Two freon lines are connected to the rear of the compressor and contain Schrader valves which are used to service the system. A pressure switch is attached to the Schrader valve in the high pressure line to the condenser and is electrically connected to the compressor and the thermostat-type AIR TEMP switch on the control pedestal. The two freon lines are routed from the engine compartment through a tunnel on the bottom of the fuselage to an airscoop which houses the condenser. One line is connected to the condenser and the other line is routed to the evaporator unit above the aft baggage area. A double-shaft electric motor and two squirrel-cage type blowers on the back of the evaporator unit provide airflow through the evaporator to the cabin outlets. A receiver/drier, which serves as a reservoir for liquid freon, is mounted under the aft baggage area floor. Two freon lines connect the receiver/drier to the condenser and the thermostatic expansion valve. A sight glass on the top of the receiver/drier is covered by a plug button in the aft baggage area floor.

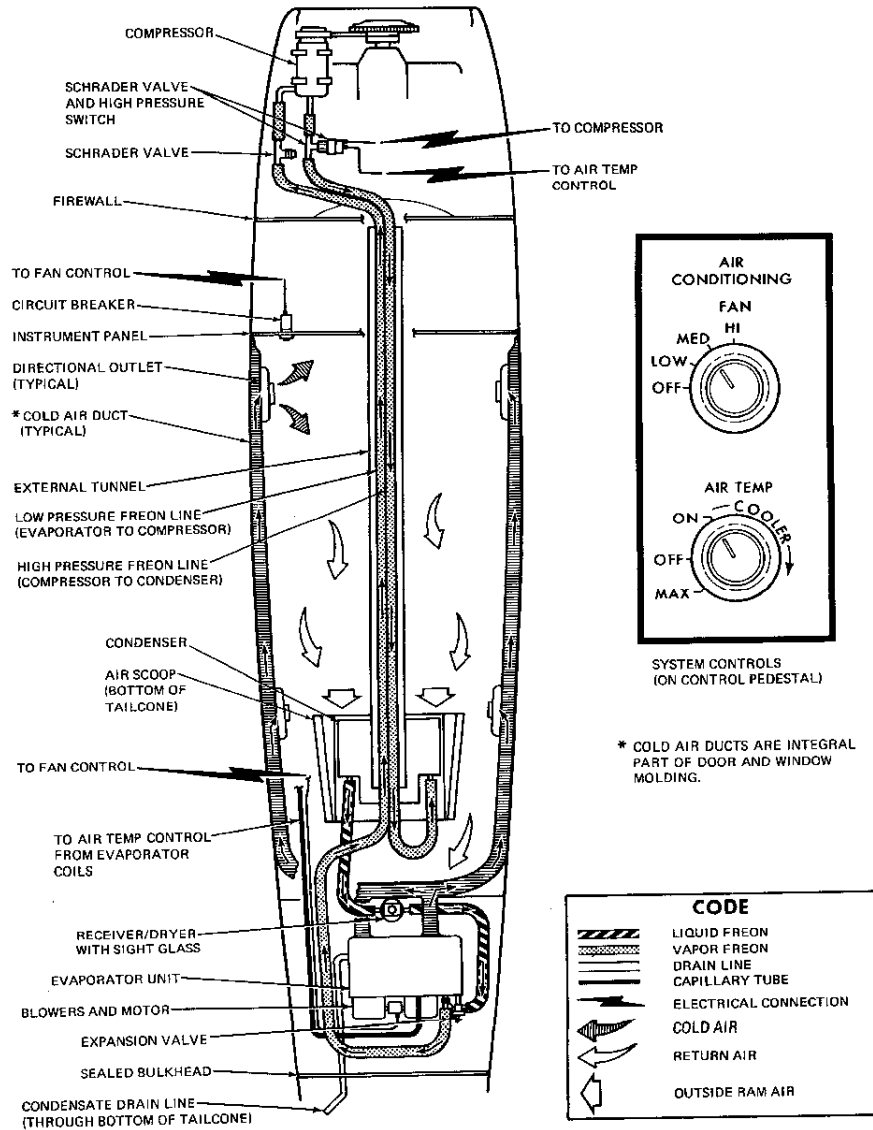

Figure 1. Air Conditioning System

In addition to air conditioner components, the airplane utilizes a special nose cap to provide room for the compressor.

SECTION 2 LIMITATIONS

The air conditioning system must not be operated during takeoff and landing.

The use of flaps for takeoff is not approved at maximum weights above 2300 pounds when the condenser fairing is not installed. With the condenser fairing installed, or at maximum weights of 2300 pounds or less, up to 10° flaps is approved.

The following information must be presented in the form of a placard, located near the engine instrument cluster.

TURN OFF AIR CONDITIONER FOR TAKEOFF AND LANDING

SECTION 3 EMERGENCY PROCEDURES

There is no change to the airplane emergency procedures when the air conditioning system is installed.

SECTION 4 NORMAL PROCEDURES

PREFLIGHT INSPECTION

During the preflight (walk-around) inspection, open both cabin doors to aid in cool-down of the cabin before flight. Air conditioning system components should be inspected as follows:

2

1. Check compressor drive belt for tightness, and compressor for condition.
2. Check tunnel from firewall to condenser air scoop for damage, looseness and evidence of line leakage.
3. Check condenser air scoop for blockage, condition, and evidence of system leakage.
4. Check that return air openings in top of aft baggage area are clean and not blocked by baggage. Also, check area for evidence of system leakage.
5. Check that condensate drain is not damaged or blocked.

If the inspection should reveal oil streaks or drops of oil in the aft baggage area or on the ground, do not operate the air conditioning system until it has been checked by service personnel.

OPERATION ON GROUND

After preflight inspection and engine start, use the following procedures for best utilization of the system prior to flight.

1. Cabin Doors and Windows -- CLOSED.
2. Cabin Air Control Knob -- PUSHED IN.
3. Wing Root Ventilators -- CLOSED.
4. AIR TEMP Control Knob -- MAX.
5. FAN Control Knob -- HI.
6. After Initial Cooldown -- REPOSITION AIR TEMP and FAN control knobs as required to maintain desired temperature.

NOTE

A high pressure switch in the air conditioning system disengages the compressor clutch and stops system operation in the event the system becomes overheated during periods of idling at low RPM. The system will cycle on and off under these circumstances and is not malfunctioning. If this occurs, head the airplane into the wind and increase engine RPM, if practical.

BEFORE TAKEOFF

1. AIR TEMP Control Knob -- OFF.
2. FAN Control Knob -- AS DESIRED.

TAKEOFF

Because of the effect of the air conditioning system on climb performance, flaps are not approved for takeoff whenever the airplane is

operated at weights above 2300 pounds and the condenser fairing is not installed. When operating with the condenser fairing installed or at maximum weights of 2300 pounds or less up to 10° of flap may be used.

At takeoff weights above 2300 pounds and without the condenser fairing installed, short field takeoffs should be conducted without flaps using a speed of 59 KIAS at the 50-foot obstacle. With the condenser fairing installed or at weights of 2300 pounds or less, the speeds on the Takeoff Distance chart in Section 5 of the basic handbook and a 10° flap setting may be used. All other speeds remain unchanged from those listed in Section 4 of the basic handbook.

OPERATION IN FLIGHT

The inflight operation of the air conditioning system is basically the same as for ground operation. If fast cool down is desired, check that all vents are closed, place the AIR TEMP control in the MAX position, and place the FAN control in the HI position. When cabin temperature has been reduced to the desired level, rotate the AIR TEMP control knob counter-clockwise as required to maintain that temperature and reposition the FAN control knob as desired.

During extended flight in extremely high temperature and humidity, the evaporator coils may frost over. The evaporator unit is equipped with an automatic defrost system which will normally prevent this. However, when the AIR TEMP control is placed in the MAX position, the automatic defrost system will not operate. This problem can be recognized by a continual rise in the temperature of the airflow from the outlets. To correct the problem, move the AIR TEMP control knob approximately one-third of the way toward the OFF position and check that the FAN control knob is in the HI position. This action should allow the automatic defrost system to remove the frost.

NOTE

If the temperature of the air coming from the outlets does not start to cool within a reasonable length of time (depending on the amount of frost), the system may be malfunctioning and should be turned off.

The blower portion of the system may be used any time air circulation (heated or fresh) is desired. This is accomplished by leaving the AIR TEMP control knob in the OFF position, and placing the FAN control knob in the LOW, MED, or HI position as desired.

BEFORE LANDING

1. AIR TEMP Control Knob -- OFF.

SUPPLEMENT

CARBURETOR AIR TEMPERATURE GAGE

SECTION 1 GENERAL

The carburetor air temperature gage provides a means of detecting carburetor icing conditions. The gage is located on the right side of the instrument panel. It is marked in 5° increments from -30°C to +30°C, and has a yellow arc between -15°C and +5°C which indicates the temperature range most conducive to carburetor icing.

SECTION 2 LIMITATIONS

There is no change to the airplane limitations when the carburetor air temperature gage is installed.

SECTION 3 EMERGENCY PROCEDURES

There is no change to the airplane emergency procedures when the carburetor air temperature gage is installed.

SECTION 4 NORMAL PROCEDURES

There is no change to the airplane normal procedures when the carburetor air temperature gage is installed. It is good practice to monitor the gage periodically and keep the needle out of the yellow arc during possible carburetor icing conditions. Refer to Section 4 of the basic handbook for procedures used when operating with carburetor heat applied.

SECTION 5

PERFORMANCE

There is no change to the airplane performance when the carburetor air temperature gage is installed. However, if it is necessary to operate with carburetor heat applied, a small performance loss may be expected at any given power setting due to the warmer induction air temperature.

SUPPLEMENT

CIRCULATION FAN SYSTEM

SECTION 1 GENERAL

The circulation fan system provides cabin ventilation during ground operations, and a better distribution of cabin air to the passengers during flight operations. The system control is located on the control pedestal, and consists of a rotary control knob, labeled CIRCULATION FAN. The control knob rotates clockwise from OFF through three positions labeled LOW, MED, and HI, providing three blower speeds. System electrical protection is provided by a 5-amp circuit breaker, labeled CIR FAN, on the left side of the switch and control panel.

Additional system components (see figure 1) include a circulation fan and motor located above the extended baggage compartment, system ducting, and four fully adjustable outlets above the cabin side windows. The circulation fan and motor includes an electric motor, equipped with an output shaft on each end, attached to squirrel-cage type blowers within blower housings which provide airflow through the ducts to the cabin outlets.

The volume of airflow through the cabin outlets is controlled by the rotary knob on the control pedestal; adjustable louvers on each outlet control the direction of airflow.

SECTION 2 LIMITATIONS

There is no change to the airplane limitations when the circulation fan system is installed.

4
CIRCULATION FAN
SYSTEM
MODEL 172P

PILOT'S OPERATING HANDBOOK
SUPPLEMENT

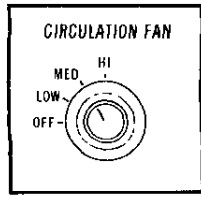

CIRCULATION FAN CONTROL
 (ON CONTROL PEDESTAL)

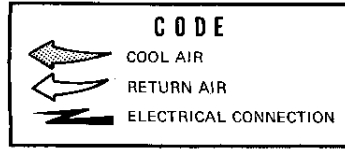

* THESE AIR DUCTS ARE INTEGRAL
 PART OF DOOR AND WINDOW
 MOLDING

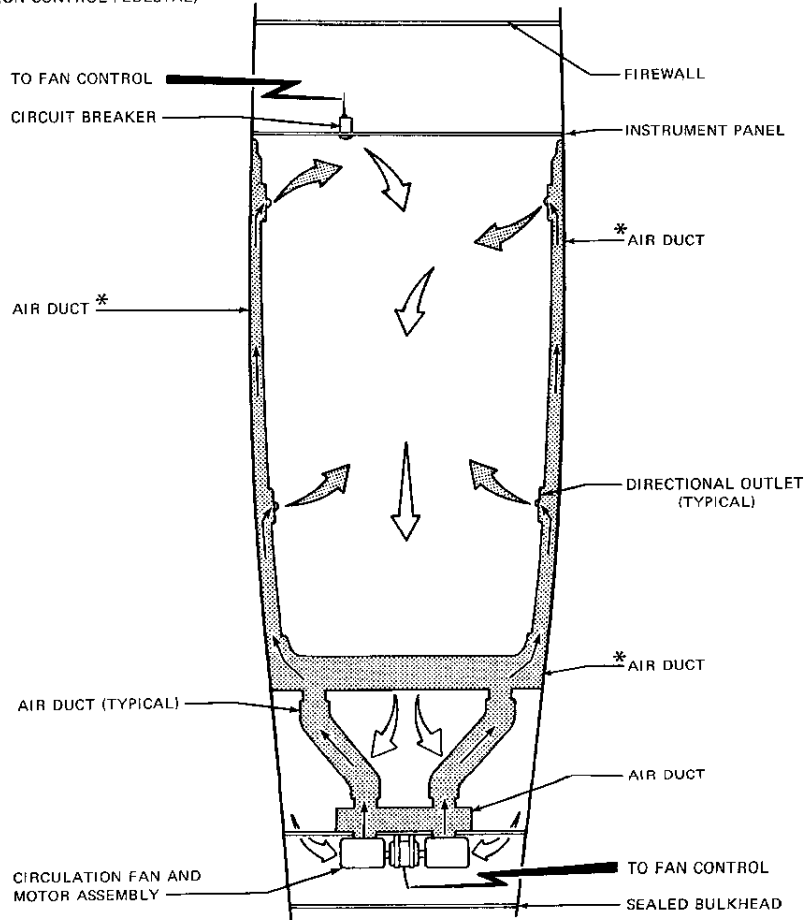

Figure 1. Circulation Fan System

SECTION 3 EMERGENCY PROCEDURES

There is no change to the airplane emergency procedures when the circulation fan system is installed.

SECTION 4 NORMAL PROCEDURES

PREFLIGHT INSPECTION

In hot weather during the preflight (walk-around) inspection, open both cabin doors to aid in cool-down of the cabin before flight.

OPERATION ON GROUND

After preflight inspection and engine start, use the following procedures for best utilization of the system prior to flight.

1. Cabin Window(s) -- OPEN.
2. Cabin Air Control Knob -- PULL OUT.
3. Wing Root Ventilators -- OPEN.
4. CIRCULATION FAN Control Knob -- HI.

BEFORE TAKEOFF

1. Cabin Window(s) -- CLOSED AND LOCKED.

OPERATION IN FLIGHT

The inflight operation of the circulation fan system is basically the same as for ground operation. The cabin air control knob, wing root ventilators, and the circulation fan control knob may be adjusted, as required to provide the desired cabin ventilation.

After landing, the cabin window(s) may be opened while taxiing to the tie-down area or ramp to help ventilate the cabin.

4
**CIRCULATION FAN
SYSTEM
MODEL 172P**

**PILOT'S OPERATING HANDBOOK
SUPPLEMENT**

SECTION 5 PERFORMANCE

There is no change to the airplane performance when the circulation fan system is installed.

SUPPLEMENT

DIGITAL CLOCK

SECTION 1

GENERAL

The Astro Tech LC-2 Quartz Chronometer (see figure 1) is a precision, solid state time keeping device which will display to the pilot the time-of-day, the calendar date, and the elapsed time interval between a series of selected events, such as in-flight check points or legs of a cross-country flight, etc. These three modes of operation function independently and can be alternately selected for viewing on the four digit liquid crystal display (LCD) on the front face of the instrument. Three push button type switches directly below the display control all time keeping functions. These control functions are summarized in figures 2 and 3.

The digital display features an internal light (back light) to ensure good visibility under low cabin lighting conditions or at night. The intensity of the back light is controlled by the RADIO LT rheostat. In addition, the display incorporates a test function (see figure 1) which allows checking that all elements of the display are operating. To activate the test function, press the LH and RH buttons at the same time.

SECTION 2

LIMITATIONS

There is no change to the airplane limitations when the digital clock is installed.

SECTION 3

EMERGENCY PROCEDURES

There is no change to the airplane emergency procedures when the digital clock is installed.

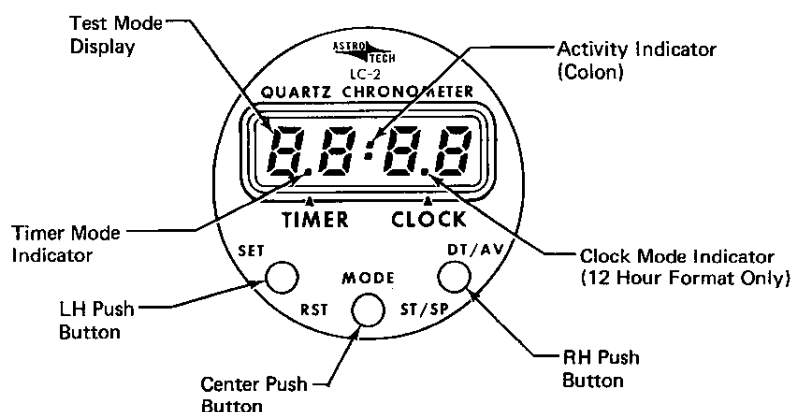

Figure 1. Digital Clock

SECTION 4 NORMAL PROCEDURES

CLOCK AND DATE OPERATION

When operating in the clock mode (see figure 2), the display shows the time of day in hours and minutes while the activity indicator (colon) will blink off for one second each ten seconds to indicate proper functioning. If the RH push button is pressed momentarily, while in the clock mode, the calendar date appears numerically on the display with month of year to the left of the colon and day of the month shown to the right of the colon. The display automatically returns to the clock mode after approximately 1.5 seconds. However, if the RH button is pressed continuously longer than approximately two seconds, the display will return from the date to the clock mode with the activity indicator (colon) blinking altered to show continuously or be blanked completely from the display. Should this occur, simply press the RH button again for two seconds or longer, and correct colon blinking will be restored.

NOTE

The clock mode is set at the factory to operate in the 24-hour format. However, 12-hour format operation may be

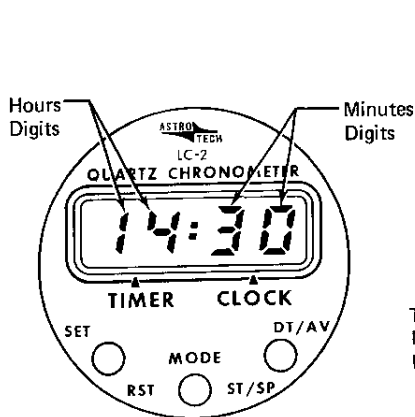

LH Button: Sets date and time of day (when used with RH button).

Center Button: Alternately displays clock or timer status

RH Button: Shows calendar date momentarily; display returns to clock mode after 1.5 seconds.

Figure 2. Clock Mode

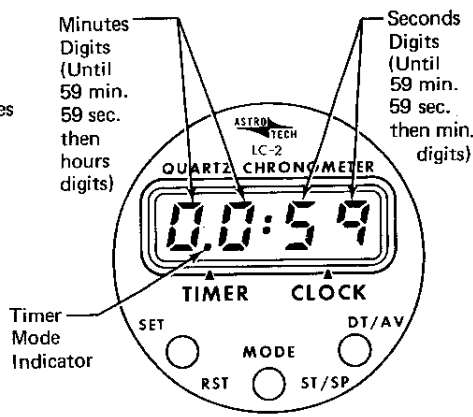

LH Button: Resets timer to "zero".

Center Button: Alternately displays clock or timer status

RH Button: Alternately starts and stops timer; timer starts from any previously accumulated total.

Figure 3. Timer Mode

selected by changing the position of an internal slide switch accessible through a small hole on the bottom of the instrument case. Notice that in the 24-hour format, the clock mode indicator does not appear.

SETTING CORRECT DATE AND TIME

The correct date and time are set while in the clock mode using the LH and RH push buttons as follows: press the LH button once to cause the date to appear with the month flashing. Press the RH button to cause the month to advance at one per second (holding button), or one per push until the correct month appears. Push the LH button again to cause the day of month to appear flashing, then advance as before using RH button until correct day of month appears.

5

DIGITAL CLOCK
MODEL 172P

PILOT'S OPERATING HANDBOOK
SUPPLEMENT

Once set correctly, the date advances automatically at midnight each day. February 29 of each leap year is not programmed into the calendar mode, and the date will advance to March 1. This may be corrected the following day by resetting the mode back to March 1.

Pressing the LH button two additional times will cause the time to appear with the hours digits flashing. Using the RH button as before, advance the hour digits to the correct hour as referenced to a known time standard. Another push of the LH button will now cause the minutes digits to flash. Advance the minutes digits to the next whole minute to be reached by the time standard and "hold" the display by pressing the LH button once more. At the exact instant the time standard reaches the value "held" by the display, press the RH button to restart normal clock timing, which will now be synchronized to the time standard.

In some instances, however, it may not be necessary to advance the minutes digits of the clock; for example when changing time zones. In such a case, do not advance the minutes digits while they are flashing. Instead, press the LH button again, and the clock returns to the normal time keeping mode without altering the minutes timing.

TIMER OPERATION

The completely independent 24-hour elapsed timer (see figure 3) is operated as follows: press the center (MODE) push button until the timer mode indicator appears. Reset the display to "zero" by pressing the LH button. Begin timing an event by pressing the RH button. The timer will begin counting in minutes and seconds and the colon (activity indicator) will blink off for 1/10 second each second. When 59 minutes 59 seconds have accumulated, the timer changes to count in hours and minutes up to a maximum of 23 hours, 59 minutes. During the count in hours and minutes, the colon blinks off for one second each ten seconds. To stop timing the event, press the RH button once again and the time shown by the display is "frozen". Successive pushes of the RH button will alternately restart the count from the "held" total or stop the count at a new total. The hold status of the timer can be recognized by lack of colon activity, either continuously on or continuously off. The timer can be reset to "zero" at anytime using the LH button.

SECTION 5 PERFORMANCE

There is no change to the airplane performance when the digital clock is installed.

SUPPLEMENT

GROUND SERVICE PLUG RECEPTACLE

SECTION 1 GENERAL

The ground service plug receptacle permits the use of an external power source for cold weather starting and during lengthy maintenance work on electrical and avionics equipment. The receptacle is located behind a door adjacent to the firewall on the left side of the lower cowl.

NOTE

If no avionics equipment is to be used or worked on, the avionics power switch should be turned off. If maintenance is required on the avionics equipment, it is advisable to utilize a battery cart external power source to prevent damage to the avionics equipment by transient voltage. Do not crank or start the engine with the avionics power switch turned on.

A special fused circuit is included with the ground service plug receptacle which will close the battery contactor when external power is applied with the master switch turned on. This circuit is intended as a servicing aid when battery power is too low to close the contactor, and should not be used to avoid performing proper maintenance procedures on a low battery.

NOTE

Use of the ground service plug receptacle for starting an airplane with a "dead" battery or charging a "dead" battery in the airplane is not recommended. The battery should be removed from the airplane and serviced in accordance with Service Manual procedures. Failure to observe this precaution could result in loss of electrical power during flight.

SECTION 2

LIMITATIONS

The following information must be presented in the form of a placard located on the inside of the ground service plug access door:

<p>CAUTION 24 VOLTS D.C. This aircraft is equipped with alternator and a negative ground system. OBSERVE PROPER POLARITY Reverse polarity will damage electrical components.</p>

SECTION 3

EMERGENCY PROCEDURES

There is no change to the airplane emergency procedures when the ground service plug receptacle is installed.

SECTION 4

NORMAL PROCEDURES

Just before connecting an external power source (generator type or battery cart), the avionics power switch should be turned off, and the master switch on.

WARNING

When turning on the master switch, using an external power source, or pulling the propeller through by hand, treat the propeller as if the ignition switch were ON. Do not stand, nor allow anyone else to stand, within the arc of the propeller, since a loose or broken wire or a component malfunction could cause the propeller to rotate.

The ground service plug receptacle circuit incorporates a polarity reversal protection. Power from the external power source will flow only if the ground service plug is correctly connected to the airplane. If the plug is accidentally connected backwards, no power will flow to the electrical system, thereby preventing any damage to electrical equipment.

The following check should be made after engine start and removal of the external power source, if there is any question as to the condition of the battery.

1. Master Switch -- OFF.
2. Taxi and Landing Light Switches -- ON.
3. Engine RPM -- REDUCE to idle.
4. Master Switch -- ON (with taxi and landing lights turned on),
5. Engine RPM -- INCREASE to approximately 1500 RPM.
6. Ammeter and Low-Voltage Warning Light -- CHECK.

NOTE

If the ammeter does not show a charge or the low-voltage warning light does not go out, the battery should be removed from the airplane and properly serviced prior to flight.

SECTION 5 PERFORMANCE

There is no change to the airplane performance when the ground service plug receptacle is installed.

SUPPLEMENT

STROBE LIGHT SYSTEM

SECTION 1 GENERAL

The high intensity strobe light system enhances anti-collision protection for the airplane. The system consists of two wing tip-mounted strobe lights (with integral power supplies), a two-position rocker switch labeled STROBE LT on the left switch and control panel, and a 5-amp "pull-off" type circuit breaker, labeled STROBE/AVN FAN, also located on the left switch and control panel.

SECTION 2 LIMITATIONS

Strobe lights must be turned off when taxiing in the vicinity of other airplanes, or during night flight through clouds, fog or haze.

SECTION 3 EMERGENCY PROCEDURES

There is no change to the airplane emergency procedures when strobe lights are installed.

SECTION 4 NORMAL PROCEDURES

To operate the strobe light system, proceed as follows:

1. Master Switch -- ON.
2. Strobe Light Switch -- ON.

7

**STROBE LIGHT SYSTEM
MODEL 172P**

**PILOT'S OPERATING HANDBOOK
SUPPLEMENT**

SECTION 5 PERFORMANCE

The installation of strobe lights will result in a minor reduction in cruise performance.

SUPPLEMENT

WINTERIZATION KIT

SECTION 1 GENERAL

The winterization kit consists of two cover plates (with placards) which attach to the air intakes in the cowling nose cap, a restrictive cover plate for the aft side of the oil cooler, insulation for the engine crankcase breather line, and a placard to be installed on the instrument panel. This equipment should be installed for operations in temperatures consistently below 20°F (-7°C). Once installed, the crankcase breather insulation is approved for permanent use, regardless of temperature.

SECTION 2 LIMITATIONS

The following information must be presented in the form of placards when the airplane is equipped with a winterization kit.

1. On each nose cap cover plate:

REMOVE WHEN
OAT EXCEEDS 20°F

2. On right hand nose cap cover plate:

REMOVE OIL COOLER COVER PLATE
FROM AFT SIDE OF OIL COOLER
WHEN OAT EXCEEDS 20°F

3. On right side of instrument panel:

WINTERIZATION KIT (RIGHT AND LEFT NOSE
CAP COVER AND OIL COOLER COVER PLATE)
MUST BE REMOVED WHEN OUTSIDE AIR
TEMPERATURE IS ABOVE 20°F.

SECTION 3 EMERGENCY PROCEDURES

There is no change to the airplane emergency procedures when the winterization kit is installed.

SECTION 4 NORMAL PROCEDURES

There is no change to the airplane normal procedures when the winterization kit is installed.

SECTION 5 PERFORMANCE

There is no change to the airplane performance when the winterization kit is installed.

SUPPLEMENT

AUDIO CONTROL PANELS

SECTION 1

GENERAL

Two types of audio control panels (see figure 1) are available for this airplane, depending upon how many transmitters are included. The operational features of both audio control panels are similar and are discussed in the following paragraphs.

TRANSMITTER SELECTOR SWITCH

When the avionics package includes a maximum of two transmitters, a two-position toggle-type switch, labeled XMTR, is provided to switch the microphone to the transmitter the pilot desires to use. If the airplane avionics package includes a third transmitter, the transmitter selector switch is a three-position rotary-type switch, labeled XMTR SEL. To select a transmitter, place the transmitter selector switch in the position number corresponding to the desired transmitter.

The action of selecting a particular transmitter using the transmitter selector switch simultaneously selects the audio amplifier associated with that transmitter to provide speaker audio. For example, if the number one transmitter is selected, the audio amplifier in the number one NAV/COM is also selected and is used for ALL speaker audio. Headset audio is not affected by audio amplifier operation.

AUDIO SELECTOR SWITCHES

Both audio control panels (see figure 1) incorporate three-position toggle-type audio selector switches for individual control of the audio systems installed in the airplane. These switches allow receiver audio to be directed to the airplane speaker or to a headset, and heard singly or in combination with other receivers. To hear a particular receiver on the airplane speaker, place that receiver's audio selector switch in the up (SPEAKER) position. To listen to a receiver over a headset, place that receiver's audio selector switch in the down (PHONE) position. The center (OFF) position turns off all audio from the associated receiver.

NOTE

Volume level is adjusted using the individual receiver volume controls on each radio.

A special feature of the audio control panel used when one or two transmitters are installed is separate control of NAV and COM audio from the NAV/COM radios. With this installation, the audio selector switches labeled NAV, 1 and 2 select audio only from the navigation receivers of the NAV/COM radios. Communication receiver audio is selected by the switches labeled COM, AUTO and BOTH. Description and operation of these switches is described in figure 1.

When the audio control panel for three transmitters is installed, audio from both NAV and COM frequencies is combined, and is selected by the audio selector switches labeled NAV/COM, 1, 2 and 3.

COM AUTO AUDIO SELECTOR SWITCH

The audio control panel used with either one or two transmitters incorporates a three-position toggle switch, labeled COM AUTO, which is provided to automatically match the audio of the appropriate NAV/COM communications receiver to the radio selected by the transmitter selector switch.

COM BOTH AUDIO SELECTOR SWITCH

The audio control panel used with either one or two transmitters incorporates a three-position toggle switch, labeled COM BOTH, which is provided to allow both COM receivers to be monitored at the same time.

AUTO AUDIO SELECTOR SWITCH

The audio control panel used with three transmitters incorporates a three-position toggle switch, labeled AUTO, which is provided to automatically match the audio of the appropriate NAV/COM receiver to the selected transmitter.

ANNUNCIATOR LIGHTS BRIGHTNESS AND TEST SWITCH

The audio control panel used with either one or two transmitters incorporates a three-position toggle switch with NITE (up) and DAY (middle) positions to control the brightness level of the marker beacon indicator lights, and the BC and RN Nav indicator lights (when installed). In the TEST (down) position, all annunciator lights (Mkr Bcn, BC and RN) will illuminate full bright to verify lighting test.

NOTE

A potentiometer is installed inside the audio control panel to provide further minimum light dimming capabilities. Refer to the appropriate Avionics Service/Parts manual for adjustment procedures.

SIDETONE OPERATION

Cessna radios are equipped with sidetone capability (monitoring of the operator's own voice transmission). While adjusting speaker sidetone, be aware that if the sidetone volume level is set too high, audio feedback (squeal) may result when transmitting.

When the airplane has one or two transmitters, sidetone is provided in either the speaker or headset anytime the COM AUTO selector switch is utilized. Placing the COM AUTO selector switch in the OFF position will eliminate sidetone. Sidetone internal adjustments are available to the pilot through the front of the audio control panel (see figure 1).

When the airplane has three transmitters, sidetone will be heard on either the speaker or a headset as selected with the AUTO selector switch. Sidetone may be eliminated by placing the AUTO selector switch in the OFF position, and utilizing the individual audio selector switches. Adjustment of speaker and headset sidetone volume can only be accomplished by adjusting the sidetone potentiometers located inside the audio control panel.

NOTE

Sidetone is not available on HF Transceiver (Type ASB-125), when installed.

OPTIONAL INTERCOM SYSTEM

The optional intercom system is a pilot and copilot intercom phone system which is only offered with the one and two transmitter type audio control panel. The system incorporates its own audio amplifier with a volume control (labeled INT) and a "hot mike" feature. The intercom system is used with the headphones only.

The "hot mike" feature allows the pilot and copilot to communicate at anytime through their microphone/headsets without having to key the mike. However, they must key the mike button on their control wheel to transmit over the aircraft's transceiver. Sidetone is present on the intercom system when the COM AUTO switch is in the PHONE position.

NOTE

Any ambient noise attenuating type padded headset and boom mike combination may not be compatible with this system.

The intercom audio volume is controlled by the INT knob located on the front of the audio control panel. Clockwise rotation of the knob increases the volume of the intercom audio and counterclockwise rotation decreases it. The INT knob controls the audio volume for the intercom system only. Receiver audio volume is adjusted using the individual receiver volume controls. When the intercom system is not being used, the INT volume control should be turned full counterclockwise to eliminate any noise over the headphones.

NOTE

When the intercom volume is turned up and an auxiliary mike is plugged in, there will be a loud squeal over the speaker if the COM BOTH and COM AUTO switches are inadvertently placed in the opposite positions (one in the SPEAKER position and the other in the PHONE position). To eliminate this squeal turn the volume down or place both switches in the same position.

When the optional intercom system is not installed, a plug button will be installed in place of the INT volume control knob.

USED WITH ONE OR TWO TRANSMITTERS

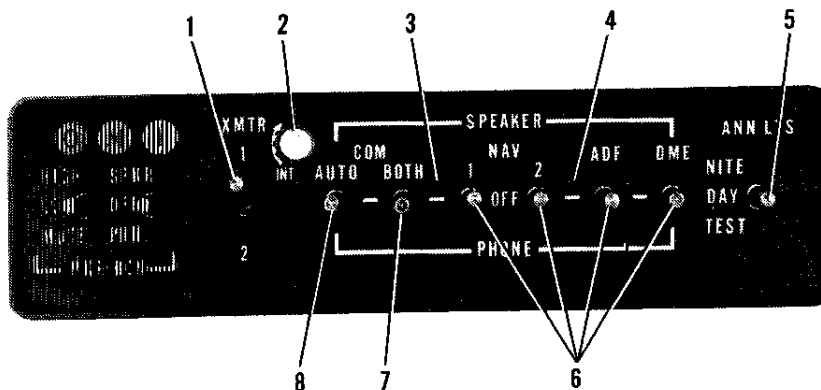

USED WITH THREE TRANSMITTERS OR DUAL ADF'S

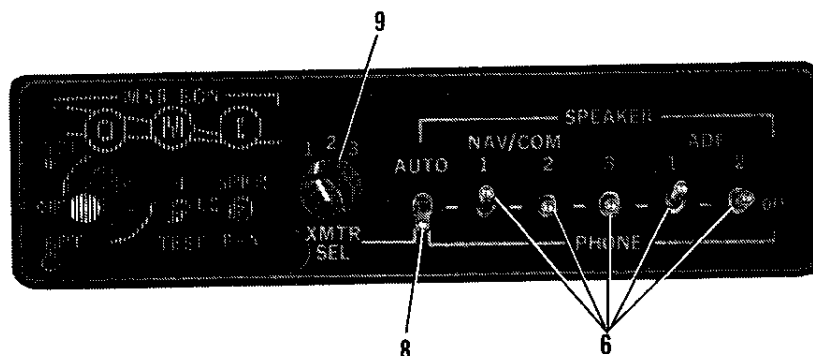

1. TRANSMITTER SELECTOR SWITCH (XMTR) - A two-position toggle switch used to activate the audio amplifier and switch the microphone to the desired transmitter. The number 1 (up position) and 2 (down position) corresponds to the first and second (from top to bottom) transmitters, respectively.

Figure 1. Audio Control Panel Operating Controls
(Sheet 1 of 2)

2. INTERCOM VOLUME CONTROL (INT) - Controls the intercom audio volume. Clockwise rotation of the knob increases the intercom audio volume and counterclockwise rotation decreases it.
3. HEADSET SIDETONE INTERNAL ADJUSTMENT ACCESS - To adjust headset sidetone, remove the plug button, place COM AUTO selector switch in the PHONE position, insert a small screwdriver into the adjustment potentiometer and rotate it clockwise to increase the sidetone volume or counterclockwise to decrease sidetone.
4. SPEAKER SIDETONE INTERNAL ADJUSTMENT ACCESS - To adjust speaker sidetone, remove the plug button, place COM AUTO selector switch in the SPEAKER position, insert a small screwdriver into the adjustment potentiometer and rotate it clockwise to increase the sidetone volume or counterclockwise to decrease sidetone. While adjusting sidetone, be aware that if the sidetone volume level is set too high, audio feedback (squeal) may result when transmitting.
5. ANNUNCIATOR LIGHTS BRIGHTNESS SELECTOR AND TEST SWITCH (ANN LTS-NITE/DAY/TEST) - Three-position toggle switch; in the up (NITE) position, annunciator lights (Mkr Bcn, BC and RN) will show at a reduced light level for typical night operations. In the center (DAY) position, annunciator lights (Mkr Bcn, BC and RN) will show full bright to verify lamp operation. In the NITE position, annunciator light (Mkr Bcn, BC and RN) level can be further adjusted down to a preset minimum using the RADIO LT dimming rheostat knob.
6. AUDIO SELECTOR SWITCHES - Three-position selector switches used to select either SPEAKER or PHONE operation for audio outputs. Enables the operator to select any one or more, audio signals on either SPEAKER or PHONE at the same time or to silence audio when placed in the OFF position.
7. COM BOTH AUDIO SELECTOR SWITCH (COM BOTH) - A three-position toggle switch used to allow both COM receivers to be monitored at the same time. Placing the COM BOTH switch in the up (SPEAKER) position will enable the pilot to monitor both the number 1 and number 2 COM receivers over the SPEAKER at the same time. Placing the switch in the down (PHONE) position allows the pilot to monitor both the number 1 and number 2 COM receivers through the headset at the same time. Center (OFF) position, removes the non-selected COM receiver (or both COM receivers if COM AUTO switch is OFF) from the audio system.
8. COM AUTO AUDIO SELECTOR SWITCH (COM AUTO OR AUTO) - A three-position toggle switch provided to automatically match the audio of the appropriate NAV/COM communications receiver to the transmitter selected by the transmitter selector switch. In the up (SPEAKER) position, audio from the selected receiver will be heard on the airplane speaker. In the down (PHONE) position, audio from the selected receiver will be heard through the headset. Center (OFF) position, removes the automatic SPEAKER/PHONE selection feature and will also disable the sidetone feature.
9. TRANSMITTER SELECTOR SWITCH (XMTR SEL) - A three-position rotary switch used to activate the audio amplifier and switch the microphone to the desired transmitter. The numbers 1, 2 and 3 positions correspond to the first, second and third (from top to bottom) transmitters, respectively.

Figure 1. Audio Control Panel Operating Controls
(Sheet 2 of 2)

SECTION 2 LIMITATIONS

There is no change to the airplane limitations when either of these audio control panels is installed.

SECTION 3 EMERGENCY PROCEDURES

In the event the audio amplifier in use fails, as evidenced by loss of all speaker audio, selecting an alternate transmitter will reestablish speaker audio using the alternate transmitter audio amplifier.

SECTION 4 NORMAL PROCEDURES

AUDIO CONTROL PANEL OPERATIONS:

1. Transmitter Selector (XMTR or XMTR SEL) Switch -- SELECT desired transmitter for transceiver operation.
2. COM AUTO or AUTO Selector Switch -- SELECT SPEAKER or PHONE position to automatically select SPEAKER or PHONE audio.

NOTE

If the NAV/COM audio selector switch corresponding to the selected transmitter is in the PHONE position with the AUTO selector switch in the SPEAKER position, all audio selector switches placed in the PHONE position will automatically be connected to both the airplane speaker and any headsets in use.

3. COM BOTH Selector Switch -- SELECT the same SPEAKER or PHONE position which was set on the COM AUTO selector switch to allow both COM receivers to be monitored at the same time.

NOTE

The combination of placing the COM AUTO switch in the SPEAKER position and the COM BOTH switch in the PHONE position (or vice versa) is not normally recommended as it will cause audio from both communications receivers (and any other navigation receiver with its audio selector switch in the PHONE position) to be heard on both the airplane speaker and the headset simultaneously.

4. Audio SPEAKER/PHONE Selector Switches -- SELECT desired SPEAKER or PHONE audio position only if COM AUTO switch is not used.
5. INT Control Knob -- ROTATE as desired to increase or decrease intercom audio volume.
6. ANN LTS Switch:
 - a. TEST Position -- SELECT to verify operation of marker beacon, BC and RN annunciator lights (when installed).
 - b. DAY Position -- SELECT for typical daytime lighting.
 - c. NITE Position -- SELECT for typical night lighting.

NOTE

In the NITE position, further lighting adjustment for the Mkr Bcn, BC and RN (when installed) annunciator lights can be obtained using the RADIO LT dimming rheostat knob.

SECTION 5 PERFORMANCE

There is no change to the airplane performance when either of these audio control panels is installed.

SUPPLEMENT

DME

(TYPE 450C WITH IND-450C INDICATOR)

SECTION 1

GENERAL

The DME-450C system consists of a panel-mounted IND-450C Indicator, a remotely-mounted TCR-451 Transceiver and an externally-mounted antenna.

Except for selection of the operating channel, which is selected by the VHF navigation receiver frequency selector switches, the DME-450C system is capable of independent operation. The DME-450C transmits interrogating pulse pairs on 200 channels between 1041 MHz and 1150 MHz; it receives associated ground-to-air replies between 978 MHz and 1213 MHz. The IND-450C digitally displays distances to or from the selected station up to 200 nautical miles, aircraft ground speed from 30 to 399 knots, or time-to-station with a maximum time of 120 minutes. A Nav mode selector switch provides selection of ON/OFF, Nav 1, Nav 2, Hold and RNAV operation. A DME display selector switch provides selection of distance to or from station (NM), aircraft ground speed (KTS) or time-to-station (MIN). An ambient light sensor automatically controls brightness of digital display and annunciators.

SECTION 2

LIMITATIONS

There is no change to the airplane limitations when this avionics equipment is installed.

SECTION 3

EMERGENCY PROCEDURES

There is no change to the airplane emergency procedures when this avionics equipment is installed.

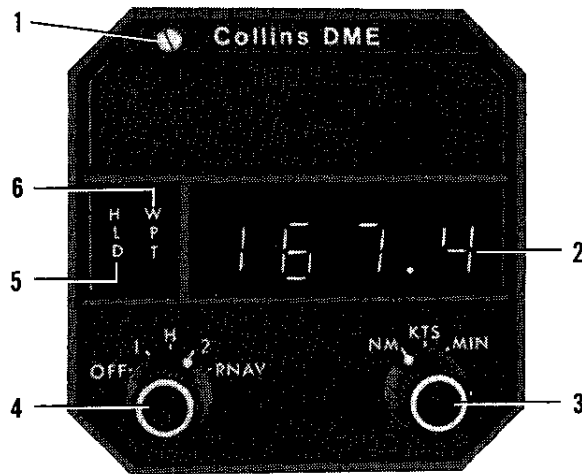

1. AMBIENT LIGHT SENSOR - Senses ambient cockpit light and controls brightness of digital display and WPT and HLD annunciators.
2. DIGITAL DISPLAY - Displays distance to or from station (NM), aircraft ground speed (KTS), or time-to-station (MIN), depending on the position of the display selector (3).

NOTE

Dashes will be observed on the display until station lock-on occurs in the NM mode or until a velocity of at least 30 knots is established with lock-on in the KTS or MIN mode.

NOTE

In all DME modes except RNAV, aircraft ground speed and time-to-station are meaningful only when the aircraft track is directly to or from the ground station. The KTS and MIN indications require approximately 1.5 minutes after station acquisition for final accuracy.

3. DME DISPLAY SELECTOR SWITCH - Selects desired mode readouts as follows:
NM Position: Displays distance to or from the selected station in nautical miles up to 199.9 nmi.
KTS Position: Displays aircraft ground speed up to 399 knots.
MIN Position: Displays time-to-station with a maximum time of 120 minutes.

Brightness of this switch is controlled by the radio light dimming rheostat.

Figure 1. IND-450C Indicator
(Sheet 1 of 2)

4. NAV MODE SELECTOR SWITCH - Applies power to the DME and selects DME operating modes as follows:
- OFF: Turns the DME OFF.
 - NAV 1: Selects DME operation with No. 1 VHF navigation set; enables channel selection by Nav 1 frequency selector switches.
 - HOLD: Selects DME memory circuit; DME remains channeled to station to which it was last channeled when HOLD was selected and will continue to display information relative to this channel. Allows both the Nav 1 and Nav 2 navigation receivers to be set to new operational frequencies without affecting the previously selected DME operation.

CAUTION

In the Hold mode there is no annunciation of the VOR/DME station frequency. However, an annunciator labeled "HLD" will illuminate on the DME to flag the pilot that the DME is in the Hold mode.

NAV 2: Selects DME operation with No. 2 VHF navigation set; enables channel selection by Nav 2 frequency selector switches.
RNAV: Selects area navigation operation.

Brightness of this switch is controlled by the radio light dimming rheostat.

5. HOLD ANNUNCIATOR (HLD) - Illuminates amber to indicate HOLD mode is selected.
6. WAYPOINT ANNUNCIATOR (WPT) - Illuminates amber to indicate RNAV mode is selected. (Annunciator will not illuminate when DME is installed without RNAV.)

Figure 1. IND-450C Indicator
(Sheet 2 of 2)

SECTION 4

NORMAL PROCEDURES

DME OPERATION

1. NAV 1 and NAV 2 VHF Navigation Receivers -- ON; SET frequency selector switches to VOR/DME station frequencies as required.
2. NAV Mode Selector Switch -- SET to NAV 1 or NAV 2.

NOTE

When the VOR frequency is selected, the appropriate DME frequency is automatically channeled.

3. DME SPEAKER/PHONE Selector Switch (on audio control panel) -- SET to desired mode to identify station ident tone.
4. DME Display Selector Switch -- SELECT desired readout.

DME HOLD FUNCTION:

The HOLD position is selected when the currently controlling Nav receiver (1 or 2) frequency is about to be changed but the pilot wishes the DME to remain operating on the current frequency after the navigation frequency has been changed.

1. NAV Mode Selector Switch -- SELECT HOLD.

CAUTION

Inadvertent switching to any other DME Nav Mode position other than HOLD must be avoided, since this could cause the DME to display erroneous information.

2. NAV 1 or NAV 2 Receiver -- SELECT new operating frequency.

SECTION 5

PERFORMANCE

There is no change to the airplane performance when this avionic equipment is installed. However, the installation of an externally-mounted antenna or several related external antennas, will result in a minor reduction in cruise performance.

SUPPLEMENT

EMERGENCY LOCATOR TRANSMITTER (ELT)

SECTION 1 GENERAL

The ELT consists of a self-contained dual-frequency radio transmitter and battery power supply, and is activated by an impact of 5g or more as may be experienced in a crash landing. The ELT emits an omni-directional signal on the international distress frequencies of 121.5 and 243.0 MHz. (Some ELT units in export aircraft transmit only on 121.5 MHz.) General aviation and commercial aircraft, the FAA, and CAP monitor 121.5 MHz, and 243.0 MHz is monitored by the military. Following a crash landing, the ELT will provide line-of-sight transmission up to 100 miles at 10,000 feet. The ELT supplied in domestic aircraft transmits on both distress frequencies simultaneously at 75 mw rated power output for 50 continuous hours in the temperature range of -4°F to +131°F (-20°C to +55°C). The ELT unit in export aircraft transmits on 121.5 MHz at 25 mw rated power output for 50 continuous hours in the temperature range of -4°F to +131°F (-20°C to +55°C).

The ELT is readily identified as a bright orange unit mounted on the right hand side of the baggage compartment wall in the tailcone. To gain access to the unit, remove the cover. The ELT is operated by a control panel at the forward facing end of the unit (see figure 1).

SECTION 2 LIMITATIONS

The following information must be presented in the form of a placard located on the baggage compartment wall.

EMERGENCY LOCATOR TRANSMITTER
INSTALLED BEHIND THIS COVER.
MUST BE SERVICED IN ACCORDANCE
WITH FAR 91.52

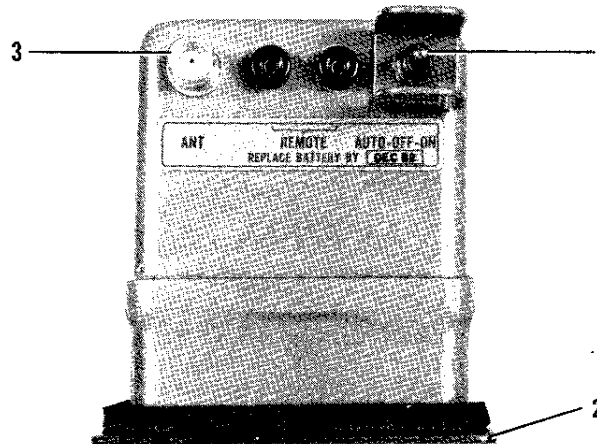

1. FUNCTION SELECTOR SWITCH (3-position toggle switch):
 - ON - Activates transmitter instantly. Used for test purposes and if "g" switch is inoperative.
 - OFF - Deactivates transmitter. Used during shipping, storage and following rescue.
 - AUTO - Activates transmitter only when "g" switch receives 5g or more impact.
2. COVER - Removable for access to battery pack.
3. ANTENNA RECEPTACLE - Connects to antenna mounted on top of tailcone.

Figure 1. ELT Control Panel

SECTION 3 EMERGENCY PROCEDURES

Immediately after a forced landing where emergency assistance is required, the ELT should be utilized as follows.

1. ENSURE ELT ACTIVATION --Turn a radio transceiver ON and select 121.5 MHz. If the ELT can be heard transmitting, it was activated by the "g" switch and is functioning properly. If no emergency tone is audible, gain access to the ELT and place the function selector switch in the ON position.

2. PRIOR TO SIGHTING RESCUE AIRCRAFT -- Conserve airplane battery. Do not activate radio transceiver.
3. AFTER SIGHTING RESCUE AIRCRAFT -- Place ELT function selector switch in the OFF position, preventing radio interference. Attempt contact with rescue aircraft with the radio transceiver set to a frequency of 121.5 MHz. If no contact is established, return the function selector switch to ON immediately.
4. FOLLOWING RESCUE -- Place ELT function selector switch in the OFF position, terminating emergency transmissions.

SECTION 4 NORMAL PROCEDURES

As long as the function selector switch remains in the AUTO position, the ELT automatically activates following an impact of 5g or more over a short period of time.

Following a lightning strike, or an exceptionally hard landing, the ELT may activate although no emergency exists. To check your ELT for inadvertent activation, select 121.5 MHz on your radio transceiver and listen for an emergency tone transmission. If the ELT can be heard transmitting, place the function selector switch in the OFF position and the tone should cease. Immediately place the function selector switch in the AUTO position to re-set the ELT for normal operation.

SECTION 5 PERFORMANCE

There is no change to the airplane performance data when this equipment is installed.

SUPPLEMENT

AREA NAVIGATION SYSTEM

(TYPE ANS-351C)

SECTION 1

GENERAL

The Area Navigation System (Type ANS-351C) consists of an ANS-351C Area Navigation Computer, a compatible Cessna 300 or 400 Series VHF navigation receiver with a course deviation indicator, and a DME-450C System with an IND-450C Indicator.

There are two types of Course Deviation Indicators which may be used with this Area Navigation System. Either a type IN-442AR Indicator with VOR/LOC capabilities, or a type IN-443AR Indicator with VOR/LOC/ILS capabilities may be coupled with the No. 2 navigation receiver. These 400 Series Indicators are not equipped with a course datum synchro to provide course datum information to the autopilot.

NOTE

This is the only installation in which a 400 Series Radio and 400 Series Indicator, coupled with a slaved gyro system, are installed without Course Datum.

The ANS-351C Area Navigation Computer contains concentric rotary switches for waypoint definition entry, an eight-waypoint number selector, an enroute/approach sensitivity control, use and return pushbuttons for waypoint management, a check pushbutton, electronic displays for data readout, and an ambient light sensor to control brightness of digital displays and annunciators. Primary power is applied to the ANS-351C by the Number 2 VHF Navigation Receiver to which it is coupled.

The ANS-351C Area Navigation Computer calculates the following parameters when activated: Crosstrack deviation of the aircraft from the selected course and to/from information displayed on the associated CDI, and (as selected on the DME) ground speed displayed in knots, time-to-waypoint displayed in minutes, or distance-to-waypoint displayed in nautical miles.

The ANS-351C Area Navigation Computer has a built-in flag circuit which causes the waypoint display number to blink anytime a non-active waypoint is displayed. Another built-in flag circuit is built into the RNAV Computer to alert the pilot that the system is not operating in the RNAV mode and that the RNAV has electrically been eliminated from the system, *making the computer transparent to all incoming data. When the DME has been switched to NAV 1, HOLD or NAV 2, the RADIAL readout will be flagged with either the word "Vor" or "Loc" to alert the pilot that RNAV mode is inactive.* An additional flag circuit is provided in the CDI which causes a red OFF flag to appear anytime a non-usable VOR/DME signal is being received.

CAUTION

If RNAV set is removed from the airplane or becomes inoperative, the associated VHF navigation indicator will be inoperative.

The DME-450C system used in conjunction with this RNAV system consists of a panel-mounted IND-450C Indicator, a remotely-mounted TCR-451 Transceiver and an externally-mounted antenna.

Except for selection of the operating channel, which is selected by the VHF navigation receiver frequency selector switches, the DME-450C system is capable of independent operation. However, only the RNAV mode is to be used with this RNAV system. The DME-450C transmits interrogating pulse pairs on 200 channels between 1041 MHz and 1150 MHz; it receives associated ground-to-air replies between 978 MHz and 1213 MHz. The IND-450C digitally displays distances to or from the selected station up to 200 nautical miles, aircraft ground speed from 30 to 399 knots, or time-to-station with a maximum time of 120 minutes. A Nav mode selector switch provides selection of ON/OFF, Nav 1, Nav 2, Hold and RNAV operation. A DME display selector switch provides selection of distance to or from station (NM), aircraft ground speed (KTS) or time-to-station (MIN). An ambient light sensor automatically controls display intensity.

All operating controls and displays which are part of the ANS-351C Area Navigation Computer, IND-450C Indicator and Course Deviation Indicators IN-442AR and IN-443AR are shown and described in Figure 1. Other controls required for operation of the ANS-351C RNAV system with DME-450C are included on the VHF Nav 2 receiver and are shown and described in the 300 and 400 Nav/Com (Types RT-385A and RT-485A) Supplements in this section.

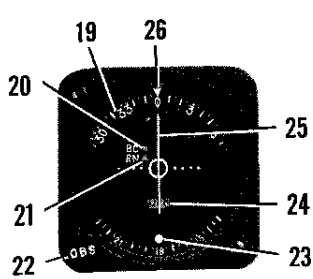
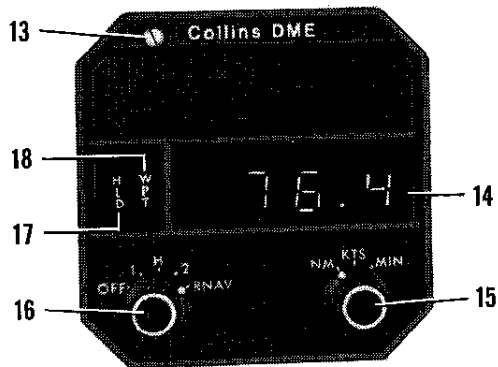
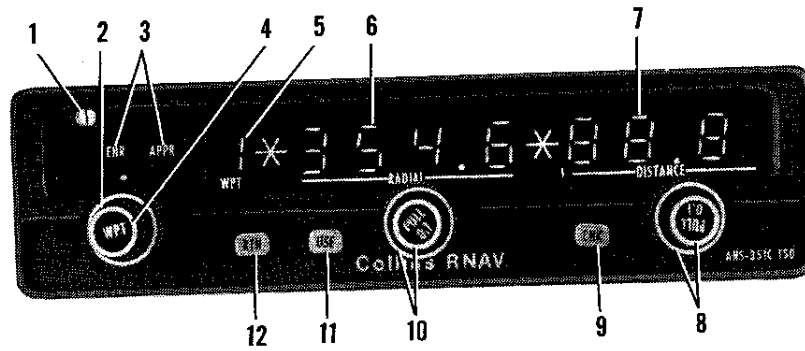

IN-442AR STANDARD VOR/LOC CDI

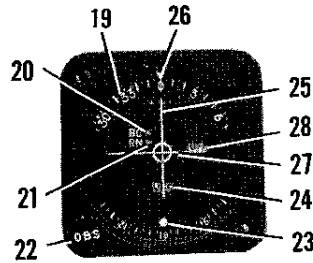

IN-443AR OPTIONAL VOR/LOC/ILS CDI

Figure 1. ANS-351C Computer, IND-450C Indicator
and Associated CDI Controls (Sheet 1 of 5)

12

RNAV
(TYPE ANS-351C)

PILOT'S OPERATING HANDBOOK SUPPLEMENT

1. AMBIENT LIGHT SENSOR - Senses ambient cockpit light and controls brightness of digital displays (5, 6, 7) and ENR/ APPR annunciators (3).
2. MODE CONTROL KNOB - Selects ENR (enroute) or APPR (approach) modes of operation. In the enroute mode, CDI deviation is 1 nmi/dot, 5 nmi full scale. In approach, deviation is 0.25 nmi/dot, 1 1/4 nmi full scale deflection out to 40 nmi from the waypoint.
3. ENROUTE AND APPROACH MODE ANNUNCIATOR LIGHTS (ENR/ APPR) - When the annunciator light illuminates amber under either ENR or APPR modes, it indicates selection of ENR (enroute) sensitivity (1 nmi/dot) or APPR (approach) sensitivity (0.25 nmi/dot).
4. WAYPOINT SELECTOR KNOB (WPT) - Selects the desired display waypoints, from 1 through 8.
5. WAYPOINT NUMBER DISPLAY (WPT 1 thru 8) - Digitally displays (from 1 thru 8) the selected waypoint defined by the displayed data. A blinking number indicates a non-active waypoint; continuously ON number indicates the active waypoint.
6. RADIAL DISPLAY READOUT (RADIAL) - When DME is set to RNAV mode, the computer will digitally display the VOR RADIAL from the reference station on which the waypoint is located. When the DME is set to Nav 1, Hold, or Nav 2, the computer display will spell out "Vor" when a VOR frequency is selected on the Nav receiver, or "Loc" will be spelled out if a localizer frequency is selected on the Nav receiver.

NOTE

Four zeros will be displayed until desired radial data is dialed in.

7. DISTANCE DISPLAY READOUT (DISTANCE) - Digitally displays DISTANCE in nautical miles from the reference station to the waypoint.

NOTE

Three zeros will be displayed until desired distance data is dialed in.

8. DISTANCE SELECTOR KNOBS - Sets distance information in nautical miles into the display. Two concentric knobs control information as follows:

Large outer knob: Changes display in 10 nmi increments.

Small inner knob : Pushed in, changes display in 1 nmi increments.

Pulled out, changes display in 0.1 nmi increments when less than 100 nmi.

Beyond 100 nmi, changes display in 1 nmi increments.

Figure 1. ANS-351C Computer, IND-450C Indicator
and Associated CDI Controls (Sheet 2 of 5)

9. CHECK BUTTON (CHK) - When the CHK pushbutton is pressed and held, and the DME display selector switch is in the NM position, the DME indicator will display distance from the selected DME facility rather than the waypoint. As a signal that raw data is being displayed on the DME, the waypoint annunciator on the DME will be extinguished. Exercising the check feature does not disturb the RNAV calculation, RNAV course deviation display on the CDI, to/from flag or RNAV autopilot coupling. The CHK pushbutton is spring-loaded to ensure return to the RNAV position when released. Brightness of this button is controlled by the radio light dimming rheostat.
10. RADIAL SELECTOR KNOBS - Sets information into the display. Two concentric knobs control information as follows:
 - Large outer knob: Changes display in 10° increments.
 - Small inner knob: Pushed in, changes display in 1° increments.
 - Pulled out, changes display in 0.1° increments.
11. USE PUSHBUTTON - Pressing the USE pushbutton converts the displayed preview waypoint (indicated by a blinking WPT number) into the active waypoint. Brightness of this button is controlled by the radio light dimming rheostat.
12. RETURN PUSHBUTTON (RTN) - Pressing the RTN pushbutton returns the display to the previously selected active waypoint when a non-active waypoint is currently being displayed. Brightness of this button is controlled by the radio light dimming rheostat.
13. AMBIENT LIGHT SENSOR - Senses ambient cockpit light and controls brightness of digital display and WPT and HLD annunciators.
14. DIGITAL DISPLAY - Displays distance to or from station or waypoint (NM), aircraft ground speed (KTS), or time-to-station or waypoint (MIN), depending on the position of the display selector (15).

NOTE

Dashes will be observed on the display until station lock-on occurs in the NM mode or until a velocity of at least 30 knots is established with lock-on in the KTS or MIN mode.

NOTE

In all DME modes including RNAV, aircraft ground speed and time-to-station are meaningful only when the aircraft track is directly to or from the ground station or waypoint. The KTS and MIN indications require approximately 10-12 minutes in RNAV ENR mode or 4-5 minutes in the RNAV APPR mode to attain 90-95 percent final (stabilized) calculated value.

Figure 1. ANS-351C Computer, IND-450C Indicator
and Associated CDI Controls (Sheet 3 of 5)

15. DME DISPLAY SELECTOR SWITCH - Selects desired mode readouts as follows:
 NM Position: Displays distance to or from the selected station or waypoint in nautical miles up to 199.9 nmi.
 KTS Position: Displays aircraft ground speed up to 399 knots.
 MIN Position: Displays time-to-station or waypoint with a maximum time of 120 minutes.

Brightness of this switch is controlled by the radio light dimming rheostat.

16. NAV MODE SELECTOR SWITCH - Applies power to the DME and selects DME operating modes as follows:
 OFF: Turns the DME OFF.
 NAV 1: Selects DME operation with No. 1 VHF navigation set; enables channel selection by Nav 1 frequency selector switches.
 HOLD: Selects DME memory circuit; DME remains channeled to station to which it was last channeled when HOLD was selected and will continue to display information relative to this channel. Allows both the Nav 1 and Nav 2 navigation receivers to be set to new operational frequencies without affecting the previously selected DME operation.

CAUTION

In the Hold mode there is no annunciation of the VOR/DME station frequency. However, an annunciator labeled "HLD" will illuminate on the DME to flag the pilot that the DME is in the Hold mode.

NAV 2: Selects DME operation with No. 2 VHF navigation set; enables channel selection by Nav 2 frequency selector switches.
 RNAV: Selects area navigation operation with the No. 2 VHF navigation set.

Brightness of this switch is controlled by the radio light dimming rheostat.

17. HOLD ANNUNCIATOR (HLD) - Illuminates amber to indicate HOLD mode is selected.
18. WAYPOINT ANNUNCIATOR (WPT) - Illuminates amber to indicate RNAV mode is selected.
19. COURSE CARD - Indicates selected VOR or RNAV course under course index.
20. BACK-COURSE LAMP (BC) - Amber light illuminates when an autopilot's back-course function is engaged and receiver is tuned to a localizer frequency; indicates course deviation pointer is reversed. Light dimming is only available when installed with an audio control panel incorporating the annunciator lights DAY/NITE selector switch.
21. AREA NAV LAMP (RN) - When green light is illuminated, indicates that RNAV operation is selected. Light dimming is only available when installed with an audio control panel incorporating the annunciator lights DAY/NITE selector switch.

Figure 1. ANS-351C Computer, IND-450C Indicator
and Associated CDI Controls (Sheet 4 of 5)

22. OMNI BEARING SELECTOR (OBS) - Rotates course card (19) to select desired bearing to or from a VOR station or to or from a selected RNAV waypoint.
23. RECIPROCAL COURSE INDEX - Indicates reciprocal of selected VOR or RNAV course.
24. OFF/TO-FROM INDICATOR - Operates only with VOR, localizer or RNAV signal. OFF position (red flag) indicates unusable signal. With usable VOR signal, when OFF position disappears, indicates whether selected course is TO or FROM station or waypoint. With usable localizer signal, white TO flag is in view.
25. COURSE DEVIATION POINTER - Indicates course deviation from selected VOR or RNAV course or localizer centerline.
26. COURSE INDEX - Indicates selected VOR or RNAV course (bearing).
27. GLIDE SLOPE DEVIATION POINTER - Indicates deviation from ILS glide slope.
28. GLIDE SLOPE "OFF" FLAG - When visible, red OFF flag indicates unreliable glide slope signal or improperly operating equipment. Flag disappears when a reliable glide slope signal is being received.

Figure 1. ANS-351C Computer, IND-450C Indicator
and Associated CDI Controls (Sheet 5 of 5)

SECTION 2

LIMITATIONS

The following RNAV IFR approach limitation must be adhered to during airplane operation.

1. IFR Approaches -- Follow approved published RNAV instrument approach procedures.

SECTION 3

EMERGENCY PROCEDURES

There is no change to the airplane emergency procedures when this avionics equipment is installed.

SECTION 4

NORMAL OPERATION

300 & 400 NAV/COM VOR NAVIGATION CIRCUITS VERIFICATION TEST:

1. Since the TEST position on the 300 and 400 Nav/Com radios is inoperative when the Nav/Coms are coupled to this Area Navigation System, the "VOR SELF TEST OPERATION" as outlined in the 300 and 400 Nav/Com (Types RT-385A and RT-485A) Supplements cannot be used. To check out the complete system, follow the "GROUND CHECK PROCEDURES" as outlined later in this Supplement.

VOR/LOC NAVIGATION:

As a convenience to the pilot, a separate supplement (Avionic Operation Guide) is supplied to explain the various procedures for using the VHF Navigation Set for VOR and localizer navigation. Refer to the Avionic Operation Guide for flight procedures.

AREA NAVIGATION OPERATION NOTES

1. Proper RNAV operation requires valid VOR and DME inputs to the RNAV system. In certain areas, the ground station antenna patterns and transmitter power may be inadequate to provide valid signals to the RNAV. For this reason, intermittent RNAV signal loss may be experienced enroute. Prolonged loss of RNAV signal shall require the pilot to revert to other navigational procedures.
2. As the flight progresses, sequence through waypoints in order, always keep within range of VORTAC being used by maintaining proper altitude and distance from the facility. If usable range is exceeded, the OFF flag will appear on the CDI. Normally, switching waypoints should be done long before flag appearances to ensure the accurate distance, ground speed, time-to-waypoint and minimum crosstrack deviation that will result if closest and strongest signal is used.
3. Selection of the Nav 1, Hold, or Nav 2 positions on the DME Nav mode selector switch electrically eliminates the ANS-351C from the RNAV system, making the computer non-receptive to all incoming data. When operating in these conventional VOR/DME modes, the ANS-351C RADIAL display will spell out "Vor" or "Loc" to prevent being misled into believing that an RNAV waypoint is being flown. Rotating the waypoint selector knob allows preview and set up of waypoints even though operating in the conventional DME modes. Attempting to activate a waypoint in the conventional DME modes by pressing the USE pushbutton will yield no results and the WPT number display will remain blinking, indicating a preview waypoint. Pressing the RTN button will restore the "Vor" or "Loc" annunciation on the RADIAL display and the previously preset waypoints will remain in memory.

NOTE

The ILS mode selection takes precedence over all other mode selection and is automatic whenever an ILS frequency is selected on the No. 2 navigation receiver.

4. If at anytime an ILS frequency is selected on the No. 2 set, with the ANS-351C operating in the RNAV mode, operation will be restored on the same waypoint when a VOR frequency is again selected. This feature allows channeling through ILS frequencies without changing the selected waypoint number.

5. Ground speed, time-to-waypoint, and distance-to-waypoint functions require stabilization time after initial function selection has been made. Allowing 10 minutes for stabilization when operating in the ENR mode will provide a display that is 90 percent of the final calculated value; 12 minutes after initial selection, a display that is 95 percent of the final calculated value will be provided. Stabilization time can be greatly reduced if the APPR mode is selected just prior to, or immediately after, the time that any one of the subject functions is selected. The APPR mode switches in a speed-up circuit that reduces the time for 90 percent of final value display to 4 minutes, and the time for 95 percent of final value display to 5 minutes. After stabilization is achieved, the ENR/APPR control may be switched back to ENR for normal enroute operation.
6. Course changes in excess of 45 degrees will result in temporary display changes for ground speed, time-to-waypoint, or distance-to-waypoint. Initially, ground speed will decrease and both time-to-waypoint and distance-to-waypoint will increase after the course change is made. After the new course has been established for several minutes, all functions will again stabilize and display final calculated values. Course changes exceeding 120 degrees require stabilization time greater than 12 minutes in ENR mode or 5 minutes in APPR mode.
7. For accurate CDI sensitivity, approach mode is restricted to 50 nautical miles or less from the waypoint in use. Enroute mode is restricted to distances no greater than 200 nautical miles from the waypoint in use.
8. VOR/DME facilities must be co-located.
9. The display of time-to-station/waypoint on the DME display, when in RNAV mode, is only valid if aircraft track is "TO" the waypoint.

GROUND CHECK PROCEDURES:

Before each flight in which RNAV is to be used for primary guidance, the following procedures should be used, when possible, to verify RNAV system performance.

1. Taxi the aircraft to position free and clear of metal structures and within good reception distance of a local VOR/DME facility.

2. SPEAKER/PHONE Selector Switches (on audio control panel) -- SET NAV 2 to desired mode.
3. COM OFF/VOL Control --TURN ON; adjust NAV VOL control to desired audio level.
4. NAV Frequency Selection (on No. 2 Nav Receiver) -- SELECT the local VOR/DME frequency.
5. DME NAV Mode Selector Switch -- SELECT RNAV mode.
6. DME DISPLAY Selector Switch -- SET to NM.
7. RNAV Mode Control Knob -- SELECT APPR (approach) mode.
8. RADIAL and DISTANCE Selector Knobs -- SELECT all zeros.
9. NAV 2 Indicator OBS Knob -- ROTATE to center the course deviation pointer.
10. DME DIGITAL DISPLAY -- NOTE DME distance display readout (after the CDI and Distance displays have stabilized).
11. RNAV CHK Button -- PRESS to display raw VOR/DME data. The DME distance-to-VOR readout should agree with the previous (step 10) RNAV DME distance-to-waypoint readout within 0.5NM.
12. DME NAV MODE Selector Switch -- SELECT NAV 2 and observe that the CDI remains within 2 dots of center and check that the DME distance-to VOR display remains within 0.5 NM of the distance displayed in step 10.

PREVIEWING AND MODIFYING WAYPOINTS:

NOTES

Modifications to the active waypoint should not be made while the RNAV system is coupled to the autopilot.

Any of the waypoints may be previewed at anytime in any mode.

1. WPT Selector Knob -- ROTATE until the desired waypoint number is displayed.
2. WPT Number Display -- OBSERVE that number is blinking, indicating that the waypoint is a preview waypoint and not the active waypoint.
3. RADIAL and DISTANCE Selector Knobs -- SET as desired if preview waypoint is to be modified.

NOTE

Only the displayed waypoint, whether it is the active waypoint or a preview waypoint, will be affected by the data (Radial and Distance) selector switches.

4. RTN Pushbutton -- PRESS to return the display to the active waypoint number or operating mode (VOR or LOC).

NOTE

In the RNAV mode of operation, the waypoint selector may also be manually rotated until the active waypoint number is again displayed in lieu of using the RTN pushbutton.

5. WAYPOINT Number -- OBSERVE that number is continuously on, indicating that active waypoint is now displayed.

NOTE

Previewing waypoints, whether in the conventional VOR/DME modes or RNAV mode, will not affect system operation in any way.

WAYPOINT PROGRAMMING ON THE GROUND:

1. Using a VFR sectional, enroute instrument chart, instrument approach plate, or enroute RNAV chart -- DETERMINE distance and radial for desired waypoints from appropriate VOR/DME stations.

NOTE

Start engine prior to turning ON avionics equipment.

2. VHF NAV 2 Receiver -- ON to apply power to Nav receiver and RNAV set.
3. DME Nav Mode Selector Switch -- RNAV.
4. WPT Selector Knob -- 1.

NOTE

When power is first applied to the RNAV set, waypoint number 1 will be displayed above the WPT legend as the active waypoint with zero RADIAL and DISTANCE displayed.

5. RADIAL and DISTANCE Selector Knobs -- ROTATE until the desired data is displayed. The displayed data will be automatically transferred into the number 1 waypoint memory.

6. REPEAT Steps 4 and 5 to program remaining waypoints.

NOTE

The displayed waypoint data in the RADIAL and DISTANCE displays before modification is never retained after new waypoint data has been entered. If the active waypoint is revised, the new data will immediately be used in the RNAV computation. Similarly, previewed waypoints, once modified, retain the new data until the waypoint definition is again modified, or the system is turned off.

7. RTN (Return) Pushbutton -- PRESS to display active waypoint.

CHANGING WAYPOINTS IN FLIGHT:

1. WPT Selector Knob -- ROTATE until the desired waypoint number and coordinates are displayed.
2. VHF Nav 2 Receiver -- SELECT the desired reference frequency and identify station by listening to ident tone.
3. Nav Indicator OBS Knob -- SET to desired course.
4. USE Pushbutton -- PRESS and observe that the waypoint identification number stops blinking.
5. DME Display Selector Switch -- SELECT desired display readout. (Distance-to-waypoint will be displayed when NM position is selected.)

NOTE

In the KTS and MIN modes, allow 10-12 minutes to attain a 90-95 percent final (stabilized) calculated value in the ENR mode or 4-5 minutes to attain a 90-95 percent final (stabilized) calculated value in the APPR mode. The NM display is accurate immediately after "lock on".

CHECK FUNCTION:

The distance of the aircraft from the selected VOR/DME station may be checked at anytime while operating in the RNAV mode whenever the DME display selector switch is in the NM position.

1. CHK Pushbutton -- PRESS and HOLD.
2. DME Digital Display -- OBSERVE distance from VOR/DME station displayed.
3. DME WAYPOINT (WPT) Annunciator -- OBSERVE WPT annunciator EXTINGUISHED as a signal that raw DME data is being displayed on the DME.
4. CHK Pushbutton -- RELEASE.

SECTION 5
PERFORMANCE

There is no change to the airplane performance when this avionic equipment is installed. However, the installation of an externally mounted antenna or several related external antennas, will result in a minor reduction in cruise performance.

SUPPLEMENT

SSB HF TRANSCEIVER

(TYPE ASB-125)

SECTION 1

GENERAL

The ASB-125 HF transceiver is an airborne, 10-channel, single sideband (SSB) radio with a compatible amplitude modulated (AM) transmitting-receiving system for long range voice communications in the 2 to 18 MHz frequency range. The system consists of a panel mounted receiver/exciter, a remote mounted power amplifier/power supply, an antenna coupler and an externally mounted, fixed wire, medium/high frequency antenna.

A channel selector knob determines the operating frequency of the transceiver which has predetermined crystals installed to provide the desired operating frequencies. A mode selector control is provided to supply the type of emission required for the channel, either sideband, AM or telephone for public correspondence. An audio knob, clarifier knob and squelch knob are provided to assist in audio operation during receive. In addition to the aforementioned controls, which are all located on the receiver/exciter, a meter is incorporated to provide antenna loading readouts.

The system utilizes the airplane microphone, headphone and speaker. Operation and description of the audio control panels used in conjunction with this radio are shown and described in another supplement in this section.

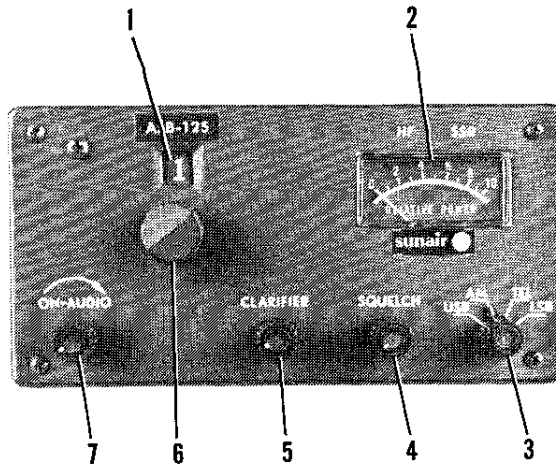

1. CHANNEL WINDOW - Displays selected channel.
2. RELATIVE POWER METER - Indicates relative radiated power of the power amplifier/antenna system.
3. MODE SELECTOR CONTROL - Selects one of the desired operating modes:
 - USB - Selects upper sideband operation for long range voice communications.
 - AM - Selects compatible AM operation and full AM reception.
 - TEL - Selects upper sideband with reduced carrier, used for public correspondence telephone and ship-to-shore.
 - LSB - (Optional) Selects lower sideband operation (not legal in U.S., Canada and most other countries).
4. SQUELCH CONTROL - Used to adjust signal threshold necessary to activate receiver audio. Clockwise rotation increases background noise (decreases squelch action); counterclockwise rotation decreases background noise.
5. CLARIFIER CONTROL - Used to "clarify" single sideband speech during receive while in USB mode only.
6. CHANNEL SELECTOR CONTROL - Selects desired channel. Also selects AM mode if channel frequency is 2003 kHz, 2182 kHz or 2638 kHz.
7. ON - AUDIO CONTROL - Turns set ON and controls receiver audio gain.

Figure 1. SSB HF Transceiver Operating Controls

SECTION 2 LIMITATIONS

There is no change to the airplane limitations when this avionic equipment is installed.

SECTION 3 EMERGENCY PROCEDURES

There is no change to the airplane emergency procedures when this avionic equipment is installed.

SECTION 4 NORMAL PROCEDURES

COMMUNICATIONS TRANSCEIVER OPERATION:

NOTE

The pilot should be aware of the two following radio operational restrictions:

- a. For sideband operation in the United States, Canada and various other countries, only the upper sideband may be used. Use of lower sideband is prohibited.
- b. Only AM transmissions are permitted on frequencies 2003 kHz, 2182 kHz and 2638 kHz. The selection of these channels will automatically select the AM mode of transmission.

1. XMTR SEL Switch (on audio control panel) -- SELECT transceiver.
2. SPEAKER/PHONE Selector Switches (on audio control panel) -- SELECT desired mode.
3. ON-AUDIO Control -- ON (allow equipment to warm up for 5 minutes for sideband or one minute for AM operation and adjust audio to comfortable listening level).
4. Channel Selector Control -- SELECT desired frequency.
5. Mode Selector Control -- SELECT operating mode.

6. SQUELCH Control -- ADJUST clockwise for normal background noise output, then slowly adjust counterclockwise until the receiver is silent.
7. CLARIFIER Control -- ADJUST when upper single sideband RF signal is being received for maximum clarity.
8. Mike Button:
 - a. To Transmit -- DEPRESS and SPEAK into microphone.

NOTE

Sidetone and interphone intercom are not available on this radio.

- b. To Receive -- RELEASE mike button.

NOTE

Voice communications are not available in the LSB mode.

NOTE

Lower sideband (LSB) mode is not legal in the U.S., Canada, and most other countries.

SECTION 5 PERFORMANCE

There is no change to the airplane performance when this avionic equipment is installed. However, the installation of an externally mounted antenna or several related external antennas, will result in a minor reduction in cruise performance.

SUPPLEMENT

CESSNA NAVOMATIC 200A AUTOPILOT (Type AF-295B)

SECTION 1 GENERAL

The Cessna 200A Navomatic is an all electric, single-axis (aileron control) autopilot system that provides added lateral and directional stability. Components are a computer-amplifier, a turn coordinator, an aileron actuator, and a course deviation indicator(s) incorporating a localizer reversed (BC) indicator light

Roll and yaw motions of the airplane are sensed by the turn coordinator gyro. The computer-amplifier electronically computes the necessary correction and signals the actuator to move the ailerons to maintain the airplane in the commanded lateral attitude.

The actuator includes a thermostatic switch which monitors the operating temperature of the motor. If the temperature becomes abnormal, the thermostatic switch opens and disengages the autopilot to remove power from the actuator. After approximately 10 minutes, the switch will automatically close to reapply power to the actuator and autopilot system.

The 200A Navomatic will also capture and track a VOR or localizer course using signals from a VHF navigation receiver.

The operating controls for the Cessna 200A Navomatic are located on the front panel of the computer-amplifier, shown in Figure 1. The primary function pushbuttons (DIR HOLD, NAV CAPT, and NAV TRK), are interlocked so that only one function can be selected at a time. The HI SENS and BACK CRS pushbuttons are not interlocked so that either or both of these functions can be selected at any time.

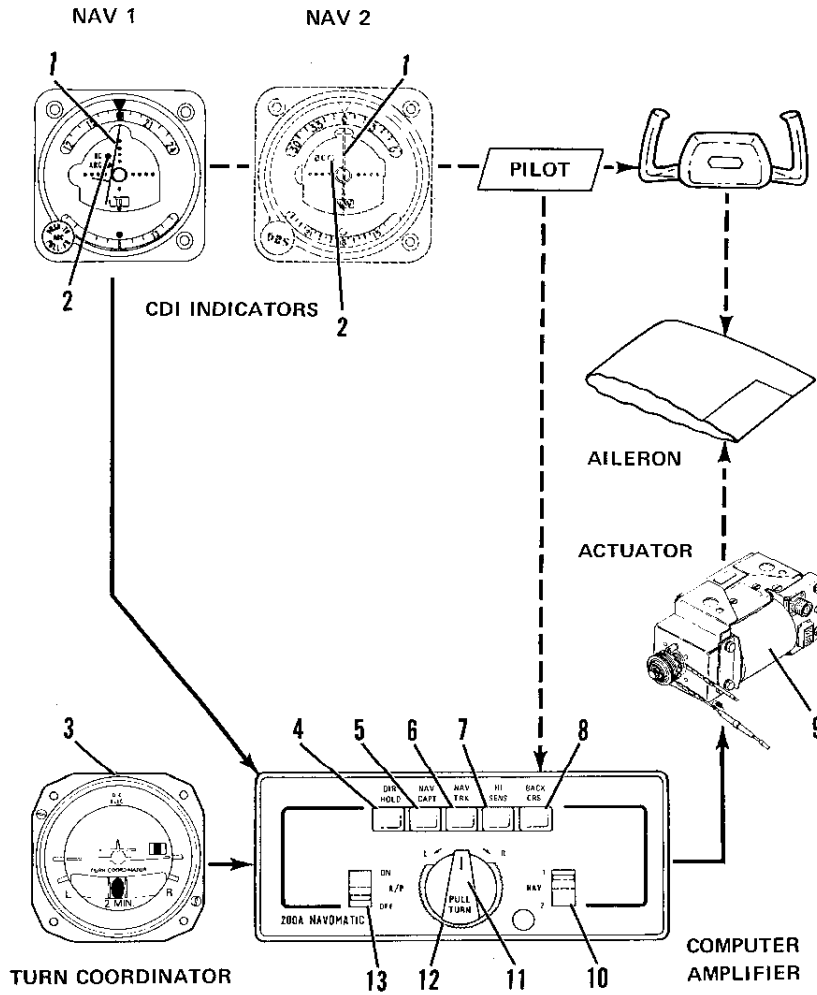

Figure 1. Cessna 200A Autopilot, Operating Controls and Indicators
 (Sheet 1 of 2)

1. COURSE DEVIATION INDICATOR - Provides VOR/LOC navigation inputs to autopilot for intercept and tracking modes.
2. LOCALIZER REVERSED INDICATOR LIGHT - Amber light, labeled BC, illuminates when BACK CRS button is pushed in (engaged) and LOC frequency selected. BC light indicates course indicator needle is reversed on selected receiver (when turned to a localizer frequency). This light is located within the CDI indicator.
3. TURN COORDINATOR - Senses roll and yaw for wings leveling and command turn functions.
4. DIR HOLD PUSHBUTTON - Selects direction hold mode. Airplane holds direction it is flying at time button is pushed.
5. NAV CAPT PUSHBUTTON - Selects NAV capture mode. When parallel to desired course, the airplane will turn to a pre-described intercept angle and capture selected VOR or LOC course.
6. NAV TRK PUSHBUTTON - Selects NAV track mode. Airplane tracks selected VOR or LOC course.
7. HI SENS PUSHBUTTON - During NAV CAPT or NAV TRK operation, this high sensitivity setting increases autopilot response to NAV signal to provide more precise operation during localizer approach. In low sensitivity position (pushbutton out), response to NAV signal is dampened for smoother tracking of enroute VOR radials; it also smooths out effect of course scalloping during NAV operation.
8. BACK CRS PUSHBUTTON - Used with LOC operation only. With A/P switch OFF or ON, and when navigation receiver selected by NAV switch is set to a localizer frequency, it reverses normal localizer needle indication (CDI) and causes localizer reversed (BC) light to illuminate. With A/P switch ON, reverses localizer signal to autopilot.
9. ACTUATOR - The torque motor in the actuator causes the ailerons to move in the commanded direction.
10. NAV SWITCH - Selects NAV 1 or NAV 2 navigation receiver.
11. PULL TURN KNOB - When pulled out and centered in detent, airplane will fly wings-level; when turned to the right (R), the airplane will execute a right, standard rate turn; when turned to the left (L), the airplane will execute a left, standard rate turn. When centered in detent and pushed in, the operating mode selected by a pushbutton is engaged.
12. TRIM - Used to trim autopilot to compensate for minor variations in aircraft trim or weight distribution. (For proper operation, the aircraft's rudder trim, if so equipped, must be manually trimmed before the autopilot is engaged.)
13. A/P SWITCH - Turns autopilot ON or OFF.

Figure 1. Cessna 200A Autopilot, Operating Controls and Indicators
(Sheet 2 of 2)

SECTION 2 LIMITATIONS

The following autopilot limitation must be adhered to:

BEFORE TAKE-OFF AND LANDING:

1. A/P ON-OFF Switch -- OFF.

SECTION 3 EMERGENCY PROCEDURES

TO OVERRIDE THE AUTOPILOT:

1. Airplane Control Wheel -- ROTATE as required to override autopilot.

NOTE

The servo may be overpowered at anytime without damage.

TO TURN OFF AUTOPILOT:

1. A/P ON-OFF Switch -- OFF.

SECTION 4 NORMAL PROCEDURES

BEFORE TAKE-OFF AND LANDING:

1. A/P ON-OFF Switch -- OFF.
2. BACK CRS Button -- OFF (see Caution note under Nav Capture).

NOTE

Periodically verify operation of amber warning light(s), labeled BC on CDI(s), by engaging BACK CRS button with a LOC frequency selected, or use TEST function on the audio control panel to verify BC light operation.

INFLIGHT WINGS LEVELING:

1. Airplane Rudder Trim -- ADJUST for zero slip ("Ball" centered on Turn Coordinator).
2. PULL-TURN Knob -- PULL out and CENTER.
3. A/P ON-OFF Switch -- ON.
4. Autopilot TRIM Control -- ADJUST for zero turn rate (wings level indication on Turn Coordinator).

NOTE

For optimum performance in airplanes equipped as float-planes, use autopilot only in cruise flight or in approach configuration with flaps down no more than 10° and airspeed no lower than 75 KIAS on 172 and R172 Series Models, 90 KIAS on 180, 185 Models and 95 KIAS on U206 and TU206 Series Models.

COMMAND TURNS:

1. PULL-TURN Knob -- PULL out and ROTATE.

DIRECTION HOLD:

1. PULL-TURN Knob -- PULL out and CENTER.
2. Autopilot TRIM Control -- ADJUST for zero turn rate.
3. Airplane Rudder Trim -- ADJUST for zero slip ("Ball" centered).
4. DIR HOLD Button -- PUSH.
5. PULL-TURN Knob -- PUSH in detent position when airplane is on desired heading.
6. Autopilot TRIM Control -- READJUST for zero turn rate.

NAV CAPTURE (VOR/LOC):

1. PULL-TURN Knob -- PULL out and CENTER.
2. NAV 1-2 Selector Switch -- SELECT desired VOR receiver.
3. Nav Receiver OBS or ARC Knob -- SET desired VOR course (if tracking omni).

NOTE

Optional ARC knob should be in center position and ARC amber warning light should be off.

4. NAV CAPT Button -- PUSH.
5. HI SENS Button -- PUSH for localizer and "close-in" omni intercepts.

6. BACK CRS Button -- PUSH only if intercepting localizer front course outbound or back course inbound.

CAUTION

With BACK CRS button pushed in and localizer frequency selected, the CDI on selected nav radio will be reversed even when the autopilot switch is OFF.

7. PULL-TURN Knob -- Turn airplane parallel to desired course.

NOTE

Airplane must be turned until heading is within $\pm 5^\circ$ of desired course.

8. PULL TURN Knob -- CENTER and PUSH in. The airplane should then turn toward desired course at $45^\circ \pm 10^\circ$ intercept angle (if the CDI needle is in full deflection).

NOTE

If more than 15 miles from the station or more than 3 minutes from intercept, use a manual intercept procedure.

NAV TRACKING (VOR/LOC):

1. NAV TRK Button -- PUSH when CDI centers and airplane is within $\pm 5^\circ$ of course heading.
2. HI SENS BUTTON -- DISENGAGE for enroute omni tracking (leave ENGAGED for localizer).
3. Autopilot TRIM Control -- READJUST as required to maintain track.

NOTE

Optional ARC function, if installed, should not be used for autopilot operation. If airplane should deviate off course, pull out PULL TURN knob and readjust airplane rudder trim for straight flight on the turn coordinator. Push in PULL TURN knob to reintercept course. If deviation persists, progressively make slight adjustments of autopilot TRIM control or heading bug on the directional gyro, towards the course as required to maintain track.

SECTION 5 PERFORMANCE

There is no change to the airplane performance when this avionic equipment is installed.

SUPPLEMENT

CESSNA 300 ADF

(Type R-546E)

SECTION 1

GENERAL

The Cessna 300 ADF is a panel-mounted, digitally tuned automatic direction finder. It is designed to provide continuous 1 kHz digital tuning in the frequency range of 200 kHz to 1,699 kHz and eliminates the need for mechanical band switching. The system is comprised of a receiver, a bearing indicator, a loop antenna, and a sense antenna. Operating controls and displays for the Cessna 300 ADF are shown and described in Figure 1. The audio systems used in conjunction with this radio for speaker-phone selection are shown and described in another supplement in this section.

The Cessna 300 ADF can be used for position plotting and homing procedures, and for aural reception of amplitude-modulated (AM) signals.

With the function selector knob at ADF, the Cessna 300 ADF provides a visual indication, on the bearing indicator, of the bearing to the transmitting station relative to the nose of the airplane. This is done by combining signals from the sense antenna with signals from the loop antenna.

With the function selector knob at REC, the Cessna 300 ADF uses only the sense antenna and operates as a conventional low-frequency receiver.

The Cessna 300 ADF is designed to receive transmission from the following radio facilities: commercial AM broadcast stations, low-frequency range stations, non-directional radio beacons, ILS compass locators.

SECTION 2

LIMITATIONS

There is no change to the airplane limitations when this avionic equipment is installed.

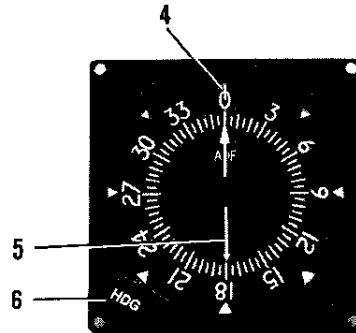
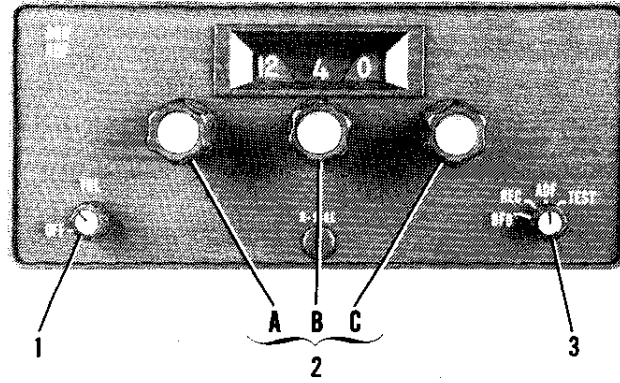

1. OFF/VOL CONTROL - Controls primary power and audio output level. Clockwise rotation from OFF position applies primary power to receiver; further clockwise rotation increases audio level.
2. FREQUENCY SELECTORS - Knob (A) selects 100-kHz increments of receiver frequency, knob (B) selects 10-kHz increments, and knob (C) selects 1 kHz increments.

Figure 1. Cessna 300 ADF Operating Controls and Indicators (Sheet 1 of 2)

3. FUNCTION SWITCH:

BFO: Selects operation as communication receiver using only sense antenna and activates 1000-Hz tone beat frequency oscillator to permit coded identifier of stations transmitting keyed CW signals (Morse Code) to be heard.

REC: Selects operation as standard communication receiver using only sense antenna.

ADF: Set operates as automatic direction finder using loop and sense antennas.

TEST: Momentary-on position used during ADF operation to test bearing reliability. When held in TEST position, slews indicator pointer clockwise; when released, if bearing is reliable, pointer returns to original bearing position.

4. INDEX (ROTATABLE CARD) - Indicates relative, magnetic, or true heading of aircraft, as selected by HDG control.
5. POINTER - Indicates station bearing in degrees of azimuth, relative to the nose of the aircraft. When heading control is adjusted, indicates relative, magnetic, or true bearing of radio signal.
6. HEADING CARD CONTROL (HDG) - Rotates card to set in relative, magnetic, or true bearing information.

Figure 1. Cessna 300 ADF Operating Controls and Indicators (Sheet 2 of 2)

SECTION 3

EMERGENCY PROCEDURES

There is no change to the airplane emergency procedures when this avionic equipment is installed.

SECTION 4

NORMAL PROCEDURES

TO OPERATE AS A COMMUNICATIONS RECEIVER ONLY:

1. OFF/VOL Control -- ON.
2. Function Selector Knob -- REC.
3. Frequency Selector Knobs -- SELECT operating frequency.
4. ADF SPEAKER/PHONE Selector Switch (on audio control panel) -- SELECT speaker or phone position as desired.
5. VOL Control -- ADJUST to desired listening level.

TO OPERATE AS AN AUTOMATIC DIRECTION FINDER:

1. OFF/VOL Control -- ON.
2. Frequency Selector Knobs -- SELECT operating frequency.
3. ADF SPEAKER/PHONE Selector Switch (on audio control panel) -- SELECT AS DESIRED.
4. Function Selector Knob -- ADF position and note relative bearing on indicator.

TO TEST RELIABILITY OF AUTOMATIC DIRECTION FINDER:

1. Function Selector Knob -- ADF position and note relative bearing on indicator.
2. Function Selector Knob -- TEST position and observe that pointer moves away from relative bearing at least 10 to 20 degrees.
3. Function Selector Knob -- ADF position and observe that pointer returns to same relative bearing as in step (1).

TO OPERATE BFO:

1. OFF/VOL Control -- ON.
2. Function Selector Knob -- BFO.
3. Frequency Selector Knobs -- SELECT operating frequency.
4. ADF SPEAKER/PHONE Selector Switch (on audio control panel) -- SELECT speaker or phone position as desired.

5. VOL Control -- ADJUST to desired listening level.

NOTE

A 1000-Hz tone is heard in the audio output when a CW signal (Morse Code) is tuned in properly.

SECTION 5 PERFORMANCE

There is no change to the airplane performance when this avionic equipment is installed. However, the installation of an externally mounted antenna or related external antennas, will result in a minor reduction in cruise performance.

Notes: _____

SUPPLEMENT

CESSNA 300 NAV/COM (720-Channel - Type RT-385A)

SECTION 1 GENERAL

The Cessna 300 Nav/Com (Type RT-385A), shown in figure 1, consists of a panel-mounted receiver-transmitter and a single or dual-pointer remote course deviation indicator.

The set includes a 720-channel VHF communications receiver-transmitter and a 200-channel VHF navigation receiver, both of which may be operated simultaneously. The communications receiver-transmitter receives and transmits signals between 118.000 and 135.975 MHz in 25-kHz steps. The navigation receiver receives omni and localizer signals between 108.00 and 117.95 MHz in 50-kHz steps. The circuits required to interpret the omni and localizer signals are located in the course deviation indicator. Both the communications and navigation operating frequencies are digitally displayed by incandescent readouts on the front panel of the Nav/Com.

A DME receiver-transmitter or a glide slope receiver, or both, may be interconnected with the Nav/Com set for automatic selection of the associated DME or glide slope frequency. When a VOR frequency is selected on the Nav/Com, associated VORTAC or VOR-DME station frequency will also be selected automatically; likewise, if a localizer frequency is selected, the associated glide slope will be selected automatically.

The course deviation indicator includes either a single-pointer and related NAV flag for VOR/LOC indication only, or dual pointers and related NAV and GS flags for both VOR/LOC and glide slope indications. Both types of course deviation indicators incorporate a back-course lamp (BC) which lights when optional back course (reversed sense) operation is selected. Both types may be provided with Automatic Radial Centering which, depending on how it is selected, will automatically indicate the bearing TO or FROM the VOR station.

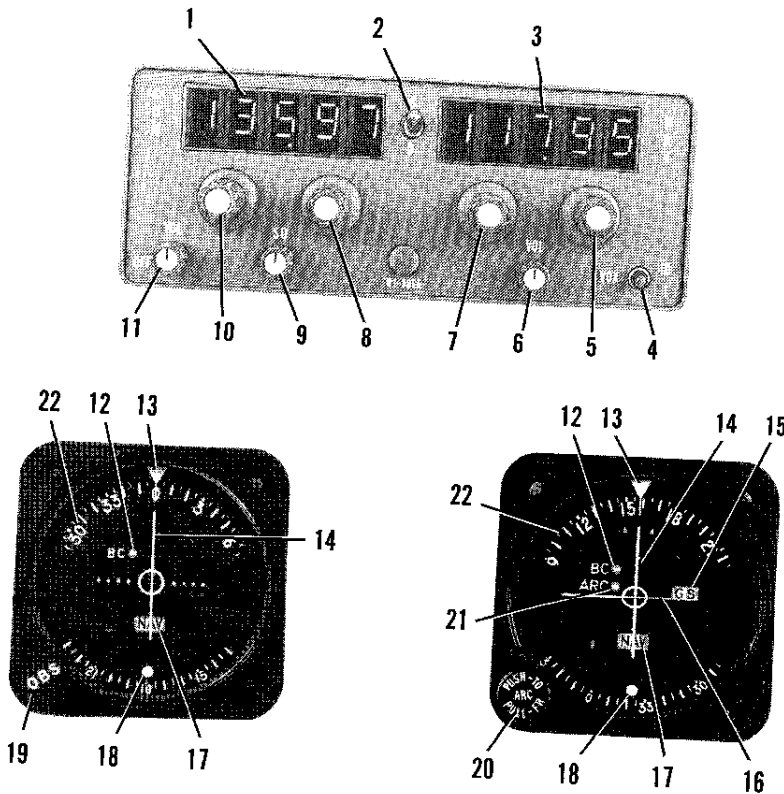

1. COMMUNICATION OPERATING FREQUENCY READOUT (Third-decimal-place is shown by the position of the "5-0" switch).
2. 5-0 SWITCH - Part of Com Receiver-Transmitter Fractional MHz Frequency Selector. In "5" position, enables Com frequency readout to display and Com Fractional MHz Selector to select frequency in .05-MHz steps between .025 and .975 MHz. In "0" position, enables COM frequency readout to display and Com Fractional MHz Selector to select frequency in .05-MHz steps between .000 and .950 MHz.

NOTE

The "5" or "0" may be read as the third decimal digit, which is not displayed in the Com fractional frequency display.

Figure 1. Cessna 300 Nav/Com (Type RT-385A), Operating Controls and Indicators (Sheet 1 of 3)

3. NAVIGATION OPERATING FREQUENCY READOUT.
4. ID-VOX-T SWITCH - With VOR or LOC station selected, in ID position, station identifier signal is audible; in VOX (Voice) position, identifier signal is suppressed; in T (Momentary On) position, the VOR navigational self-test function is selected.
5. NAVIGATION RECEIVER FRACTIONAL MEGAHERTZ SELECTOR - Selects Nav frequency in .05-MHz steps between .00 and .95 MHz; simultaneously selects paired glide slope frequency and DME channel.
6. NAV VOL CONTROL - Adjusts volume of navigation receiver audio.
7. NAVIGATION RECEIVER MEGAHERTZ SELECTOR - Selects NAV frequency in 1-MHz steps between 108 and 117 MHz; simultaneously selects paired glide slope frequency and DME channel.
8. COMMUNICATION RECEIVER-TRANSMITTER FRACTIONAL MEGAHERTZ SELECTOR - Depending on position of 5-0 switch, selects COM frequency in .05-MHz steps between .000 and .975 MHz. The 5-0 switch identifies the last digit as either 5 or 0.
9. SQUELCH CONTROL - Used to adjust signal threshold necessary to activate COM receiver audio. Clockwise rotation increases background noise (decreases squelch action); counterclockwise rotation decreases background noise.
10. COMMUNICATION RECEIVER-TRANSMITTER MEGAHERTZ SELECTOR - Selects COM frequency in 1-MHz steps between 118 and 135 MHz.
11. COM OFF-VOL CONTROL - Combination on/off switch and volume control; turns on NAV/COM set and controls volume of communications receiver audio.
12. BC LAMP - Amber light illuminates when an autopilot's back-course (reverse sense) function is engaged; indicates course deviation pointer is reversed on selected receiver when tuned to a localizer frequency. Light dimming is only available when installed with an audio control panel incorporating the annunciator lights DAY/NITE selector switch.
13. COURSE INDEX - Indicates selected VOR course.
14. COURSE DEVIATION POINTER - Indicates course deviation from selected omni course or localizer centerline.
15. GLIDE SLOPE "GS" FLAG - When visible, red GS flag indicates unreliable glide slope signal or improperly operating equipment. Flag disappears when a reliable glide slope signal is being received.
16. GLIDE SLOPE DEVIATION POINTER - Indicates deviation from ILS glide slope.

Figure 1. Cessna 300 Nav/Com (Type RT-385A), Operating Controls and Indicators (Sheet 2 of 3)

16

CESSNA 300 NAV/COM
(TYPE RT-385A)

PILOT'S OPERATING HANDBOOK
SUPPLEMENT

17. NAV/TO-FROM INDICATOR - Operates only with a VOR or localizer signal. Red NAV position (Flag) indicates unusable signal. With usable VOR signal, indicates whether selected course is TO or FROM station. With usable localizer signal, shows TO.
18. RECIPROCAL COURSE INDEX - Indicates reciprocal of selected VOR course.
19. OMNI BEARING SELECTOR (OBS) - Rotates OBS course card to select desired course.
20. AUTOMATIC RADIAL CENTERING (ARC-PUSH-TO/PULL-FR) SELECTOR - In center detent, functions as conventional OBS. Pushed to inner (Momentary On) position, turns OBS course card to center course deviation pointer with a TO flag, then returns to conventional OBS selection. Pulled to outer detent, continuously drives OBS course card to indicate bearing from VOR station, keeping course deviation pointer centered, with a FROM flag. ARC function will not operate on localizer frequencies.
21. AUTOMATIC RADIAL CENTERING (ARC) LAMP - Amber light illuminates when Automatic Radial Centering is in use. Light dimming is only available when installed with an audio control panel incorporating the annunciator lights DAY/NITE selector switch.
22. OBS COURSE CARD - Indicates selected VOR course under course index.

Figure 1. Cessna 300 Nav/Com (Type RT-385A), Operating Controls and Indicators (Sheet 3 of 3)

The Cessna 300 Nav/Com incorporates a variable threshold automatic squelch. With this squelch system, you set the threshold level for automatic operation - the further clockwise the lower the threshold - or the more sensitive the set. When the signal is above this level, it is heard even if the noise is very close to the signal. Below this level, the squelch is fully automatic so when the background noise is very low, very weak signals (that are above the noise) are let through. For normal operation of the squelch circuit, just turn the squelch clockwise until noise is heard - then back off slightly until it is quiet, and you will have automatic squelch with the lowest practical threshold. This adjustment should be rechecked periodically during each flight to assure optimum reception.

All controls for the Nav/Com, except the standard omni bearing selector (OBS) knob or the optional automatic radial centering (ARC) knob located on the course deviation indicator, are mounted on the front panel of the receiver-transmitter. Operation and description of the audio control panels used in conjunction with this radio are shown and described in another supplement in this section.

SECTION 2 LIMITATIONS

There is no change to the airplane limitations when this avionic equipment is installed.

SECTION 3 EMERGENCY PROCEDURES

There is no change to the airplane emergency procedures when this avionic equipment is installed. However, if the frequency readouts fail, the radio will remain operational on the last frequency selected. The frequency control should not be moved due to the difficulty of obtaining a known frequency under this condition.

SECTION 4

NORMAL PROCEDURES

COMMUNICATION RECEIVER-TRANSMITTER OPERATION:

1. COM OFF/VOL Control -- TURN ON; adjust to desired audio level.
2. XMTR SEL Switch (on audio control panel) -- SET to desired Nav/Com Radio.
3. SPEAKER/PHONE Selector Switches (on audio control panel) -- SET to desired mode.
4. 5-0 Fractional MHz Selector Switch -- SELECT desired operating frequency (does not affect navigation frequencies).
5. COM Frequency Selector Switch -- SELECT desired operating frequency.
6. SQ Control -- ROTATE counterclockwise to just eliminate background noise. Adjustment should be checked periodically to assure optimum reception.
7. Mike Button:
 - a. To Transmit -- DEPRESS and SPEAK into microphone.

NOTE

Sidetone may be selected by placing the AUTO selector switch (on audio control panel) in either the SPEAKER or PHONE position. Sidetone may be eliminated by placing the AUTO selector switch in the OFF position. Adjustment of sidetone on audio control panels supplied with three transmitters cannot be accomplished externally. However, audio control panels supplied with one or two transmitters have sidetone adjustment pots that are accessible through the front of the audio control panel with a small screwdriver.

- b. To Receive -- RELEASE mike button.

NAVIGATION OPERATION:

NOTE

The pilot should be aware that on Cessna airplanes equipped with the vertical fin mounted combination glide slope and omni antenna, pilots should avoid use of 2700 \pm 100 RPM on airplanes equipped with a two-bladed propeller or 1800 \pm 100 RPM on airplanes equipped with a three-bladed propeller during ILS approaches to avoid oscillations of the glide slope deviation pointer caused by propeller interference.

1. COM OFF/VOL Control -- TURN ON.
2. *SPEAKER/PHONE Selector Switches (on audio control panel)* -- SET to desired mode.
3. NAV Frequency Selector Knobs -- SELECT desired operating frequency.
4. NAV VOL -- ADJUST to desired audio level.
5. ID-VOX-T Switch:
 - a. To Identify Station -- SET to ID to hear navigation station identifier signal.
 - b. To Filter Out Station Identifier Signal -- SET to VOX to include filter in audio circuit.
6. ARC PUSH-TO/PULL-FROM Knob (If Applicable):
 - a. To Use As Conventional OBS -- PLACE in center detent and select desired course.
 - b. To Obtain Bearing TO VOR Station -- PUSH (ARC/PUSH-TO) knob to inner (momentary on) position.

NOTE

ARC lamp will illuminate amber while the OBS course card is moving to center with the course deviation pointer. After alignment has been achieved to reflect bearing to VOR, automatic radial centering will automatically shut down, causing the ARC lamp to go out.

- c. To Obtain Continuous Bearing FROM VOR Station -- PULL (ARC/PULL-FR) knob to outer detent.

NOTE

ARC lamp will illuminate amber, OBS course card will turn to center the course deviation pointer with a FROM flag to indicate bearing from VOR station.

7. OBS Knob (If Applicable) -- SELECT desired course.

VOR SELF-TEST OPERATION:

1. COM OFF/VOL Control -- TURN ON.
2. NAV Frequency Selector Switches -- SELECT usable VOR station signal.
3. OBS Knob -- SET for 0° course at course index; course deviation pointer centers or deflects left or right, depending on bearing of signal; NAV/TO-FROM indicator shows TO or FROM.
4. ID/VOX/T Switch -- PRESS to T and HOLD at T; course deviation pointer centers and NAV/TO-FROM indicator shows FROM.
5. OBS Knob -- TURN to displace course approximately 10° to either side of 0° (while holding ID/VOX/T to T). Course deviation pointer deflects full scale in direction corresponding to course displacement. NAV/TO-FROM indicator shows FROM.

NOTE

When the 300 NAV/COM is coupled to the ANS-351C RNAV system the TEST operation is non-functional. Refer to the "Ground Check Procedures" in the Area Navigation System (Type ANS-351C) Supplement in this section to verify VOR operation of the CDI.

6. ID/VOX/T Switch -- RELEASE for normal operation.

NOTE

This test does not fulfill the requirements of FAR 91.25.

SECTION 5 PERFORMANCE

There is no change to the airplane performance when this avionic equipment is installed. However, the installation of an externally mounted antenna or several related external antennas, will result in a minor reduction in cruise performance.

SUPPLEMENT
CESSNA 300 TRANSPONDER
(Type RT-359A)
AND
OPTIONAL ALTITUDE ENCODER (BLIND)

SECTION 1
GENERAL

The Cessna 300 Transponder (Type RT-359A), shown in Figure 1, is the airborne component of an Air Traffic Control Radar Beacon System (ATCRBS). The transponder enables the ATC ground controller to "see" and identify the aircraft, while in flight, on the control center's radarscope more readily.

The Cessna 300 Transponder system consists of a panel-mounted unit and an externally-mounted antenna. The transponder receives interrogating pulse signals on 1030 MHz and transmits pulse-train reply signals on 1090 MHz. The transponder is capable of replying to Mode A (aircraft identification) and also to Mode C (altitude reporting) when coupled to an optional altitude encoder system. The transponder is capable of replying on both modes of interrogation on a selective reply basis on any of 4096 information code selections. The optional altitude encoder system (not part of a standard 300 Transponder system) required for Mode C (altitude reporting) operation consists of a completely independent remote-mounted digitizer that is connected to the static system and supplies encoded altitude information to the transponder. When the altitude encoder system is coupled to the 300 Transponder system, altitude reporting information is available in 100-foot increments.

All Cessna 300 Transponder operating controls are located on the front panel of the unit. Functions of the operating controls are described in Figure 1.

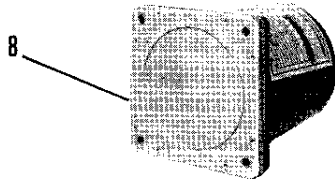
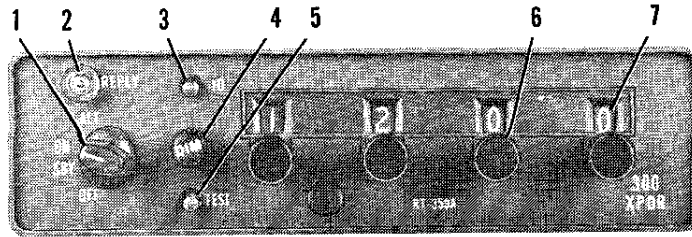

1. FUNCTION SELECTOR SWITCH - Controls application of power and selects transponder operating mode as follows:
 - OFF - Turns set off.
 - SBY - Turns set on for equipment warm-up or standby power.
 - ON - Turns set on and enables transponder to transmit Mode A (aircraft identification) reply pulses.
 - ALT - Turns set on and enables transponder to transmit either Mode A (aircraft identification) reply pulses or Mode C (altitude reporting) pulses selected automatically by the interrogating signal.
2. REPLY LAMP - Lamp flashes to indicate transmission of reply pulses; glows steadily to indicate transmission of IDENT pulse or satisfactory self-test operation. (Reply lamp will also glow steadily during initial warm-up period.)

Figure 1. Cessna 300 Transponder and Altitude Encoder (Blind)
(Sheet 1 of 2)

3. IDENT (ID) SWITCH - When depressed, selects special pulse identifier to be transmitted with transponder reply to effect immediate identification of aircraft on ground controller's display. (Reply lamp will glow steadily during duration of IDENT pulse transmission.)
4. DIMMER (DIM) CONTROL - Allows pilot to control brilliance of reply lamp.
5. SELF-TEST (TST) SWITCH - When depressed, causes transponder to generate a self-interrogating signal to provide a check of transponder operation. (Reply lamp will glow steadily to verify self-test operation.)
6. REPLY-CODE SELECTOR KNOBS (4) - Select assigned Mode A reply code.
7. REPLY-CODE INDICATORS (4) - Display selected Mode A reply code.
8. REMOTE-MOUNTED DIGITIZER - Provides an altitude reporting code range of -1000 feet up to the airplane's maximum service ceiling.

Figure 1. Cessna 300 Transponder and Altitude Encoder (Blind)
(Sheet 2 of 2)

SECTION 2 LIMITATIONS

There is no change to the airplane limitations when this avionic equipment is installed. However, the following information must be displayed in the form of a placard located near the altimeter.

ALTITUDE ENCODER EQUIPPED

SECTION 3 EMERGENCY PROCEDURES

TO TRANSMIT AN EMERGENCY SIGNAL:

1. Function Selector Switch -- ON.
2. Reply-Code Selector Knobs -- SELECT 7700 operating code.

TO TRANSMIT A SIGNAL REPRESENTING LOSS OF ALL COMMUNICATIONS (WHEN IN A CONTROLLED ENVIRONMENT):

1. Function Selector Switch -- ON.
2. Reply-Code Selector Knobs -- SELECT 7700 operating code for 1 minute; then SELECT 7600 operating code for 15 minutes and then REPEAT this procedure at same intervals for remainder of flight.

SECTION 4 NORMAL PROCEDURES

BEFORE TAKEOFF:

1. Function Selector Switch -- SBY.

TO TRANSMIT MODE A (AIRCRAFT IDENTIFICATION) CODES IN FLIGHT:

1. Reply-Code Selector Knobs -- SELECT assigned code.

2. Function Selector Switch -- ON.
3. DIM Control -- ADJUST light brilliance of reply lamp.

NOTE

During normal operation with function selector switch in ON position, reply lamp flashes indicating transponder replies to interrogations.

4. ID Button -- DEPRESS momentarily when instructed by ground controller to "squawk IDENT" (reply lamp will glow steadily, indicating IDENT operation).

TO TRANSMIT MODE C (ALTITUDE REPORTING) CODES IN FLIGHT:

1. Reply-Code Selector Knobs -- SELECT assigned code.
2. Function Selector Switch -- ALT.

NOTE

When directed by ground controller to "stop altitude squawk", turn Function Selector Switch to ON for Mode A operation only.

NOTE

Pressure altitude is transmitted by the transponder for altitude squawk and conversion to indicated altitude is done in ATC computers. Altitude squawked will only agree with indicated altitude when the local altimeter setting in use by the ground controller is set in the aircraft altimeter.

3. DIM Control -- ADJUST light brilliance of reply lamp.

TO SELF-TEST TRANSPONDER OPERATION:

1. Function Selector Switch -- SBY and wait 30 seconds for equipment to warm-up.
2. Function Selector Switch -- ON or ALT.
3. TST Button -- DEPRESS (reply lamp should light brightly regardless of DIM control setting).
4. TST Button -- RELEASE for normal operation.

SECTION 5 PERFORMANCE

There is no change to the airplane performance when this avionic equipment is installed. However, the installation of an externally mounted antenna or several related external antennas, will result in a minor reduction in cruise performance.

SUPPLEMENT

CESSNA 300 TRANSPONDER (Type RT-359A) AND OPTIONAL ENCODING ALTIMETER (Type EA-401A)

SECTION 1 GENERAL

The Cessna 300 Transponder (Type RT-359A), shown in Figure 1, is the airborne component of an Air Traffic Control Radar Beacon System (ATCRBS). The transponder enables the ATC ground controller to "see" and identify the aircraft, while in flight, on the control center's radarscope more readily.

The Cessna 300 Transponder system consists of a panel-mounted unit and an externally-mounted antenna. The transponder receives interrogating pulse signals on 1030 MHz and transmits coded pulse-train reply signals on 1090 MHz. It is capable of replying to Mode A (aircraft identification) and Mode C (altitude reporting) interrogations on a selective reply basis on any of 4096 information code selections. When an optional panel-mounted EA-401A Encoding Altimeter (not part of a standard 300 Transponder system) is included in the avionic configuration, altitude reporting information is available in 100 foot increments.

All Cessna 300 Transponder operating controls, with the exception of the optional altitude encoder's altimeter setting knob, are located on the front panel of the unit. The altimeter setting knob is located on the encoding altimeter. Functions of the operating controls are described in Figure 1.

18

CESSNA 300 TRANSPONDER AND ENCODING ALTIMETER

PILOT'S OPERATING HANDBOOK SUPPLEMENT

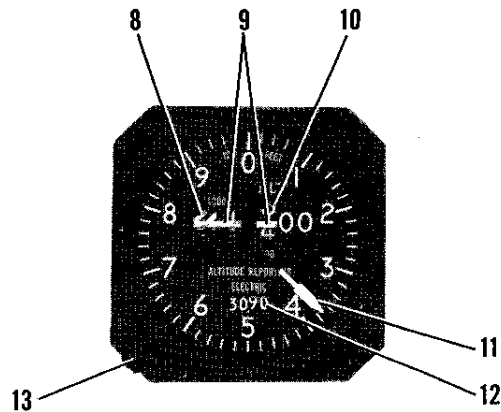
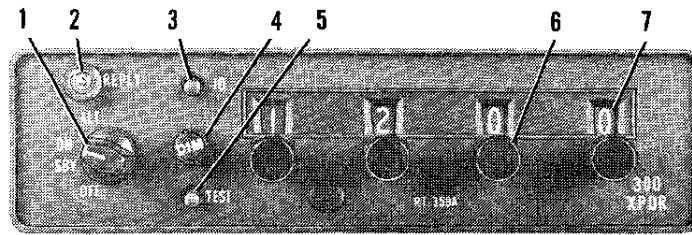

1. **FUNCTION SELECTOR SWITCH** - Controls application of power and selects transponder operating mode as follows:
 - OFF - Turns set off.
 - SBY - Turns set on for equipment warm-up.
 - ON - Turns set on and enables transponder to transmit Mode A (aircraft identification) reply pulses.
 - ALT - Turns set on and enables transponder to transmit either Mode A (aircraft identification) reply pulses or Mode C (altitude reporting) pulses selected automatically by the interrogating signal.
2. **REPLY LAMP** - Lamp flashes to indicate transmission of reply pulses; glows steadily to indicate transmission of IDENT pulse or satisfactory self-test operation. (Reply Lamp will also glow steadily during initial warm-up period.)

Figure 1. Cessna 300 Transponder and Encoding Altimeter (Sheet 1 of 2)

3. IDENT (ID) SWITCH - When depressed, selects special pulse identifier to be transmitted with transponder reply to effect immediate identification of aircraft on ground controller's display. (Reply Lamp will glow steadily during duration of IDENT pulse transmission.)
4. DIMMER (DIM) CONTROL - Allows pilot to control brilliance of reply lamp.
5. SELF-TEST (TST) SWITCH - When depressed, causes transponder to generate a self-interrogating signal to provide a check of transponder operation. (Reply Lamp will glow steadily to verify self test operation.)
6. REPLY-CODE SELECTOR KNOBS (4) - Select assigned Mode A reply code.
7. REPLY-CODE INDICATORS (4) - Display selected Mode A reply code.
8. 1000-FOOT DRUM TYPE INDICATOR - Provides digital altitude readout in 1000-foot increments between -1000 feet and +35,000 feet. When altitude is below 10,000 feet, a diagonally striped flag appears in the 10,000 foot window.
9. OFF INDICATOR WARNING FLAG - Flag appears across altitude readout when power is removed from the altimeter to indicate that readout is not reliable.
10. 100-FOOT DRUM TYPE INDICATOR - Provides digital altitude readout in 100-foot increments between 0 feet and 1000 feet.
11. 20-FOOT INDICATOR NEEDLE - Indicates altitude in 20-foot increments between 0 feet and 1000 feet.
12. ALTIMETER SETTING SCALE - DRUM TYPE - Indicates selected altimeter setting in the range of 27.9 to 31.0 inches of mercury on the standard altimeter or 950 to 1050 millibars on the optional altimeter.
13. ALTIMETER SETTING KNOB - Dials in desired altimeter setting in the range of 27.9 to 31.0 inches of mercury on the standard altimeter or 950 to 1050 millibars on the optional altimeter.

SECTION 2 LIMITATIONS

There is no change to the airplane performance when this avionics equipment is installed. However, the encoding altimeter used in this installation does have a limitation that requires a standard barometric altimeter to be installed as a back-up altimeter.

Figure 1. Cessna 300 Transponder and Encoding Altimeter (Sheet 2 of 2)

SECTION 3

EMERGENCY PROCEDURES

TO TRANSMIT AN EMERGENCY SIGNAL:

1. Function Selector Switch -- ON.
2. Reply-Code Selector Knobs -- SELECT 7700 operating code.

TO TRANSMIT A SIGNAL REPRESENTING LOSS OF ALL COMMUNICATIONS (WHEN IN A CONTROLLED ENVIRONMENT):

1. Function Selector Switch -- ON.
2. Reply-Code Selector Knobs -- SELECT 7700 operating code for 1 minute; then SELECT 7600 operating code for 15 minutes and then REPEAT this procedure at same intervals for remainder of flight.

SECTION 4

NORMAL PROCEDURES

BEFORE TAKEOFF:

1. Function Selector Switch -- SBY.

TO TRANSMIT MODE A (AIRCRAFT IDENTIFICATION) CODES IN FLIGHT:

1. Reply-Code Selector Knobs -- SELECT assigned code.
2. Function Selector Switch -- ON.
3. DIM Control -- ADJUST light brilliance of reply lamp.

NOTE

During normal operation with function selector switch in ON position, reply lamp flashes indicating transponder replies to interrogations.

4. ID Button -- DEPRESS momentarily when instructed by ground controller to "squawk IDENT" (reply lamp will glow steadily, indicating IDENT operation).

TO TRANSMIT MODE C (ALTITUDE REPORTING) CODES IN FLIGHT:

1. Off Indicator Warning Flag -- VERIFY that flag is out of view on encoding altimeter.
2. Altitude Encoder Altimeter Setting Knob -- SET IN assigned local altimeter setting.
3. Reply-Code Selector Knobs -- SELECT assigned code.
4. Function Selector Switch -- ALT.

NOTE

When directed by ground controller to "stop altitude squawk", turn Function Selector Switch to ON for Mode A operation only.

NOTE

Pressure altitude is transmitted by the transponder for altitude squawk and conversion to indicated altitude is done in ATC computers. Altitude squawked will only agree with indicated altitude when the local altimeter setting in use by the ground controller is set in the encoding altimeter.

5. DIM Control -- ADJUST light brilliance of reply lamp.

TO SELF-TEST TRANSPONDER OPERATION:

1. Function Selector Switch -- SBY and wait 30 seconds for equipment to warm-up.
2. Function Selector Switch -- ON or ALT.
3. TST Button -- DEPRESS and HOLD (reply lamp should light with full brilliance regardless of DIM control setting).
4. TST Button -- RELEASE for normal operation.

SECTION 5

PERFORMANCE

There is no change to the airplane performance when this avionic equipment is installed. However, the installation of an externally mounted antenna or several related external antennas, will result in a minor reduction in cruise performance.

SUPPLEMENT

CESSNA NAVOMATIC 300A AUTOPILOT (Type AF-395A)

SECTION 1 GENERAL

The Cessna 300A Navomatic is an all electric, single-axis (aileron control) autopilot system that provides added lateral and directional stability. Components are a computer-amplifier, a turn coordinator, a directional gyro, an aileron actuator and a course deviation indicator(s) incorporating a localizer reversed (BC) indicator light.

Roll and yaw motions of the airplane are sensed by the turn coordinator gyro. Deviations from the selected heading are sensed by the directional gyro. The computer-amplifier electronically computes the necessary correction and signals the actuator to move the ailerons to maintain the airplane in the commanded lateral attitude or heading.

The actuator includes a thermostatic switch which monitors the operating temperature of the motor. If the temperature becomes abnormal, the thermostatic switch opens and disengages the autopilot to remove power from the actuator. After approximately 10 minutes, the switch will automatically close to reapply power to the actuator and autopilot system.

The 300A Navomatic will also intercept and track a VOR or localizer course using signals from a VHF navigation receiver.

The operating controls for the Cessna 300A Navomatic are located on the front panel of the computer-amplifier and on the directional gyro, shown in Figure 1. The primary function pushbuttons (HDG SEL, NAV INT, and NAV TRK), are interlocked so that only one function can be selected at a time. The HI SENS and BACK CRS pushbuttons are not interlocked so that either or both of these functions can be selected at any time.

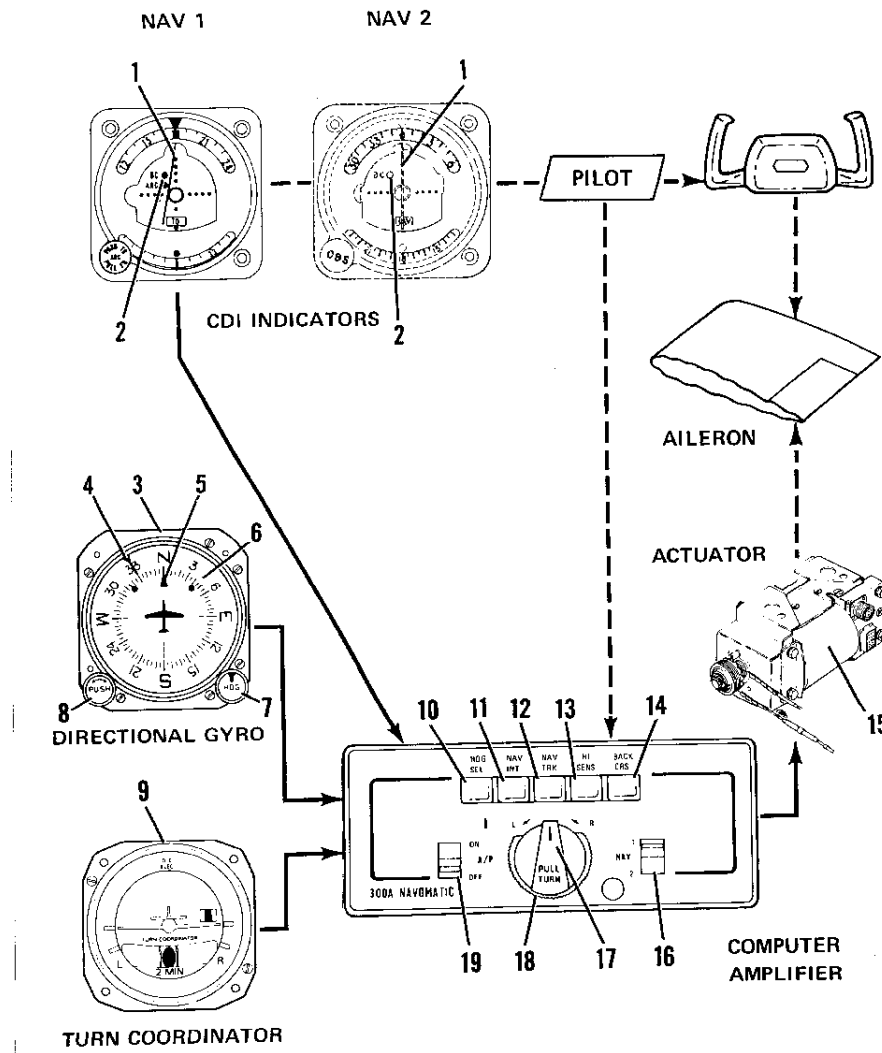

Figure 1. Cessna 300A Autopilot, Operating Controls and Indicators
(Sheet 1 of 3)

1. COURSE DEVIATION INDICATOR - Provides VOR/LOC navigation inputs to autopilot for intercept and tracking modes.
2. LOCALIZER REVERSED INDICATOR LIGHT - Amber light, labeled BC, illuminates when BACK CRS button is pushed in (engaged) and LOC frequency selected. BC light indicates course indicator needle is reversed on selected receiver (when tuned to a localizer frequency). This light is located within the CDI indicator.
3. NON-SLAVED DIRECTIONAL GYRO - Provides a stable visual indication of aircraft heading to the pilot and provides heading information to the autopilot for heading intercept and hold.
4. HEADING BUG - Moved by HDG knob to select desired heading.
5. LUBBER LINE - Indicates aircraft heading on compass card (6).
6. COMPASS CARD - Rotates to display heading of airplane with reference to lubber line (5).
7. HEADING SELECTOR KNOB (HDG) - When pushed in, the heading bug (4) may be positioned to the desired magnetic heading by rotating the HDG selector knob. Also used to select VOR or LOC course.
8. GYRO ADJUSTMENT KNOB (PUSH) - When pushed in, allows the pilot to manually rotate the compass card (6) to correspond with the magnetic heading indicated by the compass. The compass card must be manually reset periodically to compensate for precessional errors in the gyro.
9. TURN COORDINATOR - Senses roll and yaw for wings leveling and command turn functions.
10. HDG SEL PUSHBUTTON - Aircraft will turn to and hold heading selected by the heading "bug" on the directional gyro.
11. NAV INT PUSHBUTTON - When heading "bug" on DG is set to selected course, aircraft will turn to and intercept selected VOR or LOC course.
12. NAV TRK PUSHBUTTON - When heading "bug" on DG is set to selected course, aircraft will track selected VOR or LOC course.
13. HI SENS PUSHBUTTON - During NAV INT or NAV TRK operation, this high sensitivity setting increases autopilot response to NAV signal to provide more precise operation during localizer approach. In low-sensitivity position (push-button out), response to NAV signal is dampened for smoother tracking of enroute VOR radials; it also smooths out effect of course scalloping during NAV operation.
14. BACK CRS PUSHBUTTON - Used with LOC operation only. With A/P switch OFF or ON, and when navigation receiver selected by NAV switch is set to a localizer frequency, it reverses normal localizer needle indication (CDI) and causes localizer reversed (BC) light to illuminate. With A/P switch ON, reverses localizer signal to autopilot.

Figure 1. Cessna 300A Autopilot, Operating Controls and Indicators
(Sheet 2 of 3)

19

CESSNA 300A AUTOPILOT
(TYPE AF-395A)

PILOT'S OPERATING HANDBOOK
SUPPLEMENT

15. ACTUATOR - The torque motor in the actuator causes the ailerons to move in the commanded direction.
16. NAV SWITCH - Selects NAV 1 or NAV 2 navigation receiver.
17. PULL TURN KNOB - When pulled out and centered in detent, airplane will fly wings-level; when turned to the right (R), the airplane will execute a right, standard rate turn; when turned to the left (L), the airplane will execute a left, standard rate turn. When centered in detent and pushed in, the operating mode selected by a pushbutton is engaged.
18. TRIM - Used to trim autopilot to compensate for minor variations in aircraft trim or lateral weight distribution. (For proper operation, the aircraft's rudder trim, if so equipped, must be manually trimmed before the autopilot is engaged.)
19. A/P SWITCH - Turns autopilot ON or OFF.

Figure 1. Cessna 300A Autopilot, Operating Controls and Indicators
(Sheet 3 of 3)

SECTION 2 LIMITATIONS

The following autopilot limitation must be adhered to:

BEFORE TAKE-OFF AND LANDING:

1. A/P ON-OFF Switch -- OFF.

SECTION 3 EMERGENCY PROCEDURES

TO OVERRIDE THE AUTOPILOT:

1. Airplane Control Wheel -- ROTATE as required to override autopilot.

NOTE

The servo may be overpowered at any time without damage.

TO TURN OFF AUTOPILOT:

1. A/P ON-OFF Switch -- OFF.

SECTION 4 NORMAL PROCEDURES

BEFORE TAKE-OFF AND LANDING:

1. A/P ON-OFF Switch -- OFF.
2. BACK CRS Button -- OFF (see Caution note under Nav Intercept).

NOTE

Periodically verify operation of amber warning light(s), labeled BC on CDI(s), by engaging BACK CRS button with a LOC frequency selected, or use TEST function on the audio control panel to verify BC light operation.

INFLIGHT WINGS LEVELING:

1. Airplane Rudder Trim -- ADJUST for zero slip ("Ball" centered on Turn Coordinator).
2. PULL-TURN Knob -- PULL out and CENTER.
3. A/P ON-OFF Switch -- ON.
4. Autopilot TRIM Control -- ADJUST for zero turn rate (wings level indication on Turn Coordinator).

NOTE

For optimum performance in airplanes equipped as float-planes, use autopilot only in cruise flight or in approach configuration with flaps down no more than 10° and airspeed no lower than 75 KIAS on 172 and R.172 Series Models or 90 KIAS on 180, 185, U206 and TU206 Series Models.

COMMAND TURNS:

1. PULL-TURN Knob -- PULL out and ROTATE.

HEADING SELECT:

1. Directional Gyro -- SET to airplane magnetic heading.
2. Heading Selector Knob -- ROTATE bug to desired heading.
3. Heading Select Button -- PUSH.
4. PULL-TURN Knob -- CENTER and PUSH.

NOTE

Airplane will turn automatically to selected heading. If airplane fails to hold the precise heading, readjust autopilot TRIM control as required or disengage autopilot and reset manual rudder trim (if installed).

NAV INTERCEPT (VOR/LOC):

1. PULL-TURN Knob -- PULL out and CENTER.
2. NAV 1-2 Selector Switch -- SELECT desired receiver.
3. Nav Receiver OBS or ARC Knob -- SET desired VOR course (if tracking omni).

NOTE

Optional ARC knob should be in center position and ARC warning light should be off.

4. Heading Selector Knob -- ROTATE bug to selected course (VOR or localizer - inbound or outbound as appropriate).
5. Directional Gyro --SET for magnetic heading.
6. NAV INT Button -- PUSH.
7. HI SENS Button -- PUSH for localizer and "close-in" omni intercepts.
8. BACK CRS Button -- PUSH only if intercepting localizer front course outbound or back course inbound.

CAUTION

With BACK CRS button pushed in and localizer frequency selected, the CDI on selected nav radio will be reversed even when the autopilot switch is OFF.

9. PULL-TURN Knob -- PUSH.

NOTE

Airplane will automatically turn to a 45° intercept angle.

NAV TRACKING (VOR/LOC):

1. NAV TRK Button -- PUSH when CDI centers (within one dot) and airplane is within $\pm 10^\circ$ of course heading.
2. HI SENS Button -- Disengage for enroute omni tracking (leave engaged for localizer).

NOTE

Optional ARC function, if installed, should not be used for autopilot operation. If airplane should deviate off course, pull out PULL TURN knob and readjust airplane rudder trim for straight flight on the turn coordinator. Push in PULL TURN knob to reintercept course. If deviation persists, progressively make slight adjustments of autopilot TRIM control or heading bug on the directional gyro, towards the course as required to maintain track.

SECTION 5 PERFORMANCE

There is no change to the airplane performance when this avionic equipment is installed.

SUPPLEMENT

CESSNA 400 GLIDE SLOPE

(Type R-443B)

SECTION 1 GENERAL

The Cessna 400 Glide Slope is an airborne navigation receiver which receives and interprets glide slope signals from a ground-based Instrument Landing System (ILS). It is used with the localizer function of a VHF navigation system when making instrument approaches to an airport. The glide slope provides vertical path guidance while the localizer provides horizontal track guidance.

The Cessna 400 Glide Slope system consists of a remote-mounted receiver coupled to an existing navigation system, a panel-mounted indicator and an externally mounted antenna. The glide slope receiver is designed to receive ILS glide slope signals on any of 40 channels. The channels are spaced 150 kHz apart and cover a frequency range of 329.15 MHz through 335.0 MHz. When a localizer frequency is selected on the NAV receiver, the associated glide slope frequency is selected automatically.

Operation of the Cessna 400 Glide Slope system is controlled by the associated navigation system. The functions and indications of typical 300 series glide slope indicators are pictured and described in Figure 1. The 300 series glide slope indicators shown in Figure 1 depict typical indications for Cessna-crafted glide slope indicators. However, refer to the 400 Nav/Com or HSI write-ups if they are listed in this section as options for additional glide slope indicators.

SECTION 2 LIMITATIONS

There is no change to the airplane limitations when this avionics equipment is installed.

TYPICAL 300 SERIES GLIDE SLOPE INDICATORS

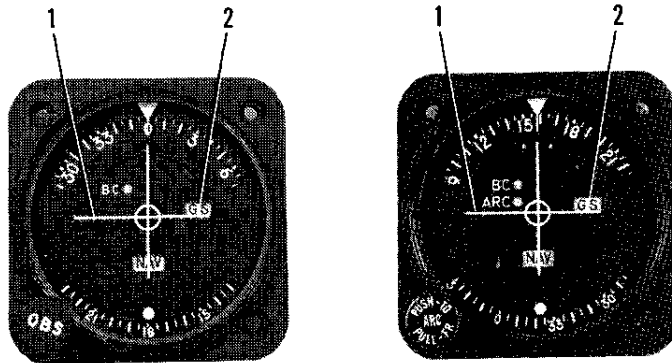

1. GLIDE SLOPE DEVIATION POINTER - Indicates deviation from normal glide slope.
2. GLIDE SLOPE "OFF" OR "GS" FLAG - When visible, indicates unreliable glide slope signal or improperly operating equipment. The flag disappears when a reliable glide slope signal is being received.

CAUTION

Spurious glide slope signals may exist in the area of the localizer back course approach which can cause the glide slope "OFF" or "GS" flag to disappear and present unreliable glide slope information. Disregard all glide slope signal indications when making a localizer back course approach unless a glide slope (ILS BC) is specified on the approach and landing chart.

Figure 1. Typical 300 Series VOR/LOC/ILS Indicator

SECTION 3 EMERGENCY PROCEDURES

There is no change to the airplane emergency procedures when this avionic equipment is installed.

SECTION 4 NORMAL PROCEDURES

TO RECEIVE GLIDE SLOPE SIGNALS:

NOTE

The pilot should be aware that on Cessna airplanes equipped with the vertical fin mounted glide slope antenna, pilots should avoid use of 2700 \pm 100 RPM on airplanes equipped with a two-bladed propeller or 1800 \pm 100 RPM on airplanes equipped with a three-bladed propeller during ILS approaches to avoid oscillations of the glide slope deviation pointer caused by propeller interference.

1. NAV Frequency Select Knobs -- SELECT desired localizer frequency (glide slope frequency is automatically selected).
2. NAV/COM VOX-ID-T Switch -- SELECT ID position to disconnect filter from audio circuit.
3. NAV VOL Control -- ADJUST to desired listening level to confirm proper localizer station.

CAUTION

When glide slope "OFF" or "GS" flag is visible, glide slope indications are unusable.

SECTION 5 PERFORMANCE

There is no change to the airplane performance when this avionic equipment is installed.

SUPPLEMENT

CESSNA 400 MARKER BEACON (Type R-402A)

SECTION 1

GENERAL

The system consists of a remote mounted 75 MHz marker beacon receiver, an antenna which is either flush mounted or externally mounted on the under side of the aircraft and operating controls and annunciator lights which are mounted on the front of the audio control panel.

Operating controls for the marker beacon system are supplied on the front of the two types of audio control panels used in this Cessna aircraft. The operating controls for the marker beacon are different on the two audio control panels. One type of audio control panel is supplied with one or two transmitters and the other is supplied with three transmitters.

The marker beacon operating controls and annunciator lights used on the audio control panel supplied with two or less transmitters are shown and described in Figure 1. The operating controls consist of three, three-position toggle switches. One switch is labeled "HIGH/LO/MUTE" and provides the pilot with HIGH-LO sensitivity selection and marker beacon audio muting, for approximately 30 seconds, to enable voice communication to be heard without interference of marker beacon signals. The marker beacon audible tone is automatically restored at the end of the 30 second muting period to continue marker audio for passage over the next marker. Another switch is labeled "SPKR/OFF/PHN" and is used to turn the set on and select the desired speaker or phone position for marker beacon signals. The third toggle switch labeled, "ANN LT", is provided to enable the pilot to select the desired DAY or NITE lighting position for annunciator lights, and also a "TEST" position to verify operation of marker beacon annunciator lights.

The marker beacon operating controls and annunciator lights used on the audio control panel supplied with three transmitters are shown and described in Figure 2. The operating controls consist of two, three-position toggle switches, and two concentric control knobs. One switch is labeled "SPKR/PHN" and is used to select the desired speaker or phone position for marker beacon signals. The other switch is labeled "HI/LO/TEST" and

21

CESSNA 400 MARKER BEACON PILOT'S OPERATING HANDBOOK (TYPE R-402A) SUPPLEMENT

provides the pilot with HI-LO sensitivity selection and a TEST position to verify operation of all annunciator lights. The small, inner control knob labeled OFF/VOL, turns the set on or off and adjusts the audio listening level. The large, outer control knob labeled BRT, provides light dimming for the marker beacon lights.

When the Cessna 400 Marker Beacon controls are incorporated in an audio control panel incorporated with two or less transmitters a marker Beacon audio level adjustment potentiometer and an annunciator lights minimum dimming potentiometer are mounted on the audio control panel circuit board. Potentiometer adjustments cannot be accomplished externally. However, if readjustments are desired, adjustments can be made in accordance with instructions found in the Avionics Installations Service/Parts Manual for this aircraft.

MARKER FACILITIES

MARKER	IDENTIFYING TONE	LIGHT*
Inner & Fan	Continuous 6 dots/sec (3000 Hz)	White
Middle	Alternate dots and dashes (1300 Hz)	Amber
Outer	2 dashes/sec (400 Hz)	Blue

* When the identifying tone is keyed, the respective indicating light will blink accordingly.

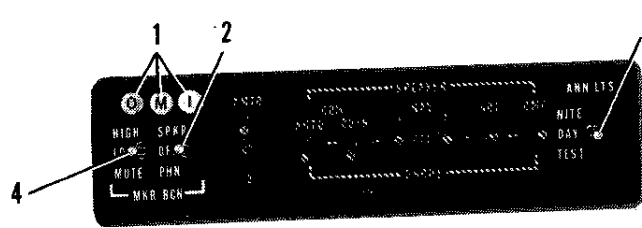

AUDIO CONTROL PANEL FOR USE WITH ONE OR TWO TRANSMITTERS

1. **MARKER BEACON ANNUNCIATOR LIGHTS:**
 OUTER - Light illuminates blue to indicate passage of outer marker beacon.
 MIDDLE - Light illuminates amber to indicate passage of middle marker beacon.
 INNER and FAN - Light illuminates white to indicate passage of inner and fan marker beacon.
2. **SPEAKER/OFF/PHONE SELECTOR SWITCH:**
 SPEAKER POSITION - Turns set on and selects speaker for aural reception.
 OFF POSITION - Turns set off.
 PHONE POSITION - Turns set on and selects phone for aural reception.
3. **ANNUNCIATOR LIGHTS SWITCH:**
 NITE POSITION - Places the annunciator lights in a dim lighting mode for night flying operations. Light intensity of the NITE position is controlled by the RADIO LT dimming rheostat.
 DAY POSITION - Places the annunciator lights in the full bright position for daylight flying operations.
 TEST POSITION - Illuminates all marker beacon annunciator lights (and other annunciators) in the full bright position to verify operation of annunciator lights.
4. **HIGH/LO/MUTE SELECTOR SWITCH:**
 HIGH POSITION - Receiver sensitivity is positioned for airway flying.
 LO POSITION - Receiver sensitivity is positioned for ILS approaches.
 MUTE POSITION - The marker beacon audio signals are temporarily blanked out (for approximately 30 seconds) and then automatically restored, over the speaker or headset in order to provide voice communications without interference of marker beacon signals.

Figure 1. Cessna 400 Marker Beacon Operating Controls and Indicator Lights Supplied with Two or Less Transmitters

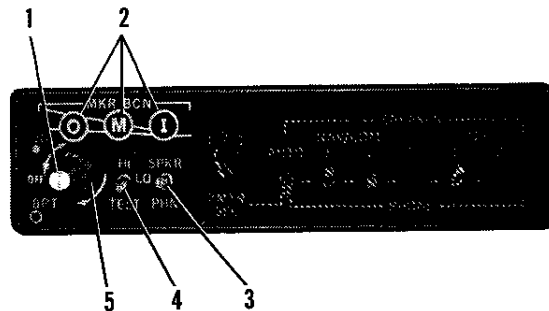

AUDIO CONTROL PANEL FOR USE WITH THREE TRANSMITTERS

1. OFF/VOLUME CONTROL:

OFF/VOL - Turns the set on or off and adjusts the audio listening level. Clockwise rotation of the smaller knob turns the set on and increases the audio level.

2. MARKER BEACON ANNUNCIATOR LIGHTS:

OUTER - Light illuminates blue to indicate passage of outer marker beacon.
MIDDLE - Light illuminates amber to indicate passage of middle marker beacon.
INNER and FAN - Light illuminates white to indicate passage of inner or fan marker beacon.

3. SPEAKER/PHONE SELECTOR SWITCH:

SPEAKER POSITION - Selects speaker for aural reception.
PHONE POSITION - Selects headphone for aural reception.

4. HI/LO/TEST SELECTOR SWITCH:

HI POSITION - Receiver sensitivity is positioned for airway flying.
LO POSITION - Receiver sensitivity is positioned for ILS approaches.
TEST POSITION - Illuminates all annunciator lights in the full bright position to verify operation of annunciator lights.

5. LIGHT DIMMING CONTROL:

BRT - Provides light dimming for the annunciator lights. Clockwise rotation of the larger knob increases light intensity.

Figure 2. Cessna 400 Marker Beacon Operating Controls and Indicator Lights Supplied With Three Transmitters.

SECTION 2 LIMITATIONS

There is no change to the airplane limitations when this avionic equipment is installed.

SECTION 3 EMERGENCY PROCEDURES

There is no change to the airplane emergency procedures when this avionic equipment is installed.

SECTION 4 NORMAL PROCEDURES

MARKER BEACON OPERATING PROCEDURES FOR USE WITH
AUDIO CONTROL PANELS PROVIDED WITH ONE OR TWO TRANS-
MITTERS (REF. FIG. 1)

1. SPKR/OFF/PHN Selector Switch -- SELECT desired speaker or phone audio. Either selected position will turn set on.
2. NITE/DAY/TEST Selector Switch -- PRESS to TEST position and verify that all marker beacon annunciator lights illuminate full bright to indicate lights are operational.
3. NITE/DAY/TEST Selector Switch -- SELECT desired position for NITE or DAY lighting.
4. HIGH/LO/MUTE Selector Switch -- SELECT HI position for airway flying or LO position for ILS approaches.

NOTE

Press MUTE switch to provide an approximate 30 seconds temporary blanking out of Marker Beacon audio tone. The marker beacon audio tone identifier is automatically restored at the end of the muting period.

NOTE

Due to the short distance typical between the middle marker and inner marker, audio identification of the inner marker may not be possible if muting is activated over the middle marker.

MARKER BEACON OPERATING PROCEDURES FOR USE WITH AUDIO CONTROL PANELS PROVIDED WITH THREE TRANSMITTERS. (REF. FIG. 2)

1. OFF/VOL Control -- TURN to VOL position and adjust to desired listening level. Clockwise rotation increases audio level.
2. HI/LO Sen Switch -- SELECT HI position for airway flying or LO position for ILS approaches.
3. SPKR/PHN Switch -- SELECT speaker or phone audio.
4. BRT Control -- SELECT BRT (full clockwise). ADJUST as desired when illuminated over marker beacon.
5. TEST Switch -- PRESS to TEST position and verify that all marker beacon annunciator lights will illuminate full bright to indicate lights are operational.

SECTION 5 PERFORMANCE

There is no change to the airplane performance when this avionic equipment is installed. However, the installation of an externally mounted antenna or several related external antennas, will result in a minor reduction in cruise performance.

SUPPLEMENT
CESSNA 400 TRANSPONDER
(Type RT-459A)
AND
OPTIONAL ALTITUDE ENCODER (BLIND)

SECTION 1
GENERAL

The Cessna 400 Transponder (Type RT-459A), shown in Figure 1, is the airborne component of an Air Traffic Control Radar Beacon System (ATCRBS). The transponder enables the ATC ground controller to "see" and identify the aircraft, while in flight, on the control center's radarscope more readily.

The Cessna 400 Transponder system consists of a panel-mounted unit and an externally mounted antenna. The transponder receives interrogating pulse signals on 1030 MHz and transmits pulse-train reply signals on 1090 MHz. The transponder is capable of replying to Mode A (aircraft identification) and also to Mode C (altitude reporting) when coupled to an optional altitude encoder system. The transponder is capable of replying on both modes of interrogation on a selective reply basis on any of 4,096 information code selections. The optional altitude encoder system (not part of a standard 400 Transponder system) required for Mode C (altitude reporting) operation, consists of a completely independent remote-mounted digitizer that is connected to the static system and supplies encoded altitude information to the transponder. When the altitude encoder system is coupled to the 400 Transponder system, altitude reporting capabilities are available in 100-foot increments between 1000 feet and the airplane's maximum service ceiling.

All Cessna 400 Transponder operating controls are located on the front panel of the unit. Functions of the operating controls are described in Figure 1.

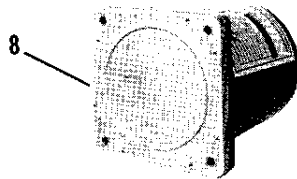
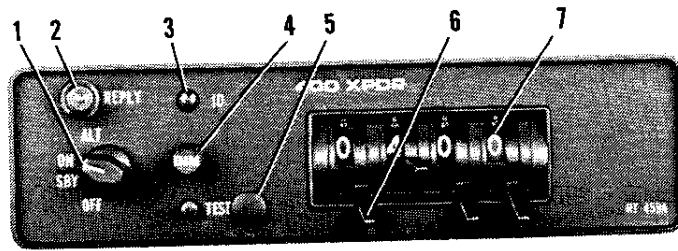

1. FUNCTION SELECTOR SWITCH - Controls application of power and selects transponder operating mode as follows:
 - OFF - Turns set off.
 - SBY - Turns set on for equipment warm-up or standby power.
 - ON - Turns set on and enables transponder to transmit Mode A (aircraft identification) reply pulses.
 - ALT - Turns set on and enables transponder to transmit either Mode A (aircraft identification) reply pulses or Mode C (altitude reporting) pulses selected automatically by the interrogating signal.
2. REPLY LAMP - Lamp flashes to indicate transmission of reply pulses; glows steadily to indicate transmission of IDENT pulse or satisfactory self-test operation. (Reply lamp will also glow steadily during initial warm-up period.)

Figure 1. Cessna 400 Transponder and Altitude Encoder (Blind)
(Sheet 1 of 2)

PILOT'S OPERATING HANDBOOK CESSNA 400 TRANSPONDER
SUPPLEMENT AND ALTITUDE ENCODER (BLIND)

3. IDENT (ID) SWITCH - When depressed, selects special pulse identifier to be transmitted with transponder reply to effect immediate identification of aircraft on ground controller's display. (Reply lamp will glow steadily during duration of IDENT pulse transmission.)
4. DIMMER (DIM) CONTROL - Allows pilot to control brilliance of reply lamp.
5. SELF-TEST (TEST) SWITCH - When depressed, causes transponder to generate a self-interrogating signal to provide a check of transponder operation. (Reply lamp will glow steadily to verify self-test operation.)
6. REPLY-CODE SELECTOR SWITCHES (4) - Select assigned Mode A reply code.
7. REPLY-CODE INDICATORS (4) - Display selected Mode A reply code.
8. REMOTE-MOUNTED DIGITIZER - Provides an altitude reporting code range of -1000 feet up to the airplane's maximum service ceiling.

Figure 1. Cessna 400 Transponder and Altitude Encoder (Blind)
(Sheet 2 of 2)

SECTION 2 LIMITATIONS

There is no change to the airplane limitations when this avionic equipment is installed. However, the following information must be displayed in the form of a placard located near the altimeter.

ALTITUDE ENCODER EQUIPPED

SECTION 3 EMERGENCY PROCEDURES

TO TRANSMIT AN EMERGENCY SIGNAL:

1. Function Selector Switch -- ON.
2. Reply-Code Selector Switches -- SELECT 7700 operating code.

TO TRANSMIT A SIGNAL REPRESENTING LOSS OF ALL COMMUNICATIONS (WHEN IN A CONTROLLED ENVIRONMENT):

1. Function Selector Switch -- ON.
2. Reply-Code Selector Switches -- SELECT 7700 operating code for 1 minute; then SELECT 7600 operating code for 15 minutes and then REPEAT this procedure at same intervals for remainder of flight.

SECTION 4 NORMAL PROCEDURES

BEFORE TAKEOFF:

1. Function Selector Switch -- SBY.

TO TRANSMIT MODE A (AIRCRAFT IDENTIFICATION) CODES IN FLIGHT:

1. Reply-Code Selector Switches -- SELECT assigned code.

2. Function Selector Switch -- ON.
3. DIM Control -- ADJUST light brilliance of reply lamp.

NOTE

During normal operation with function switch in ON position, reply lamp flashes indicating transponder replies to interrogations.

4. ID or XPDR IDENT Button -- DEPRESS momentarily when instructed by ground controller to "squawk IDENT" (reply lamp will glow steadily, indicating IDENT operation).

TO TRANSMIT MODE C (ALTITUDE REPORTING) CODES IN FLIGHT:

1. Reply-Code Selector Switches -- SELECT assigned code.
2. Function Selector Switch -- ALT.

NOTE

When directed by ground controller to "stop altitude squawk", turn Function Selector Switch to ON for Mode A operation only.

NOTE

Pressure altitude is transmitted by the transponder for altitude squawk and conversion to indicated altitude is done in ATC computers. Altitude squawked will only agree with indicated altitude when the local altimeter setting in use by the ground controller is set in the aircraft altimeter.

3. DIM Control -- ADJUST light brilliance of reply lamp.

TO SELF-TEST TRANSPONDER OPERATION:

1. Function Selector Switch -- SBY and wait 30 seconds for equipment to warm-up.
2. Function Selector Switch -- ON.
3. TEST Button -- DEPRESS (reply lamp should light brightly regardless of DIM control setting).
4. TEST Button -- RELEASE for normal operation.

SECTION 5 PERFORMANCE

There is no change to the airplane performance when this avionic equipment is installed. However, the installation of an externally mounted antenna or several related external antennas, will result in a minor reduction in cruise performance.

SUPPLEMENT
CESSNA 400 TRANSPONDER
(Type RT-459A)
AND
OPTIONAL ENCODING ALTIMETER
(Type EA-401A)

SECTION 1
GENERAL

The Cessna 400 Transponder (Type RT-459A), shown in Figure 1, is the airborne component of an Air Traffic Control Radar Beacon System (ATCRBS). The transponder enables the ATC ground controller to "see" and identify the aircraft, while in flight, on the control center's radarscope more readily.

The 400 Transponder consists of a panel-mounted unit and an externally mounted antenna. The transponder receives interrogating pulse signals on 1030 MHz and transmits coded pulse-train reply signals on 1090 MHz. It is capable of replying to Mode A (aircraft identification) and Mode C (altitude reporting) interrogations on a selective reply basis on any of 4,096 information code selections. When an optional panel mounted EA-401A Encoding Altimeter (not part of 400 Transponder System) is included in the avionic configuration, the transponder can provide altitude reporting in 100-foot increments between -1000 and +35,000 feet.

All Cessna 400 Transponder operating controls, with the exception of the optional altitude encoder's altimeter setting knob, are located on the front panel of the unit. The altimeter setting knob is located on the encoding altimeter. Functions of the operating controls are described in Figure 1.

23

**CESSNA 400 TRANSPONDER
AND ENCODING ALTIMETER**

**PILOT'S OPERATING HANDBOOK
SUPPLEMENT**

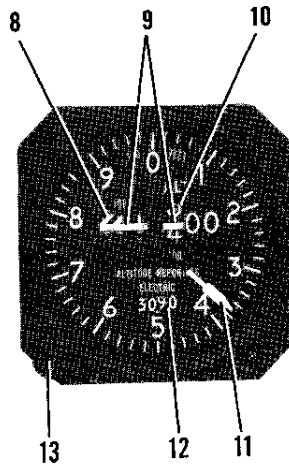
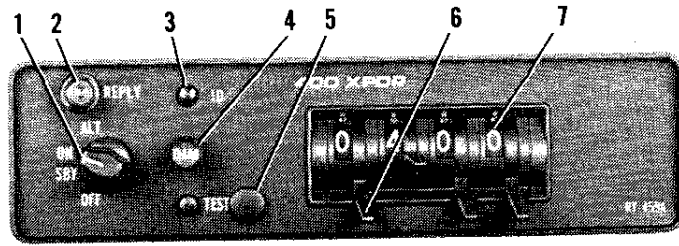

Figure 1. Cessna 400 Transponder and Encoding Altimeter
Operating Controls (Sheet 1 of 2)

1. FUNCTION SELECTOR SWITCH - Controls application of power and selects transponder operating mode as follows:
 - OFF - Turns set off.
 - SBY - Turns set on for equipment warm-up or standby power.
 - ON - Turns set on and enables transponder to transmit Mode A (aircraft identification) reply pulses.
 - ALT - Turns set on and enables transponder to transmit either Mode A (aircraft identification) reply pulses or Mode C (altitude reporting) pulses selected automatically by the interrogating signal.
2. REPLY LAMP - Lamp flashes to indicate transmission of reply pulses; glows steadily to indicate transmission of IDENT pulse or satisfactory self-test operation. (Reply Lamp will also glow steadily during initial warm-up period.)
3. IDENT (ID) SWITCH - When depressed, selects special pulse identifier to be transmitted with transponder reply to effect immediate identification of aircraft on ground controller's display. (Reply Lamp will glow steadily during duration of IDENT pulse transmission.)
4. DIMMER (DIM) CONTROL - Allows pilot to control brilliance of Reply Lamp.
5. SELF-TEST (TEST) SWITCH - When depressed, causes transponder to generate a self-interrogating signal to provide a check of transponder operation. (Reply Lamp will glow steadily to verify self test operation.)
6. REPLY-CODE SELECTOR SWITCHES (4) - Select assigned Mode A Reply Code.
7. REPLY-CODE INDICATORS (4) - Display selected Mode A Reply Code.
8. 1000-FOOT DRUM TYPE INDICATOR - Provides digital altitude readout in 1000-foot increments between -1000 and +35,000 feet. When altitude is below 10,000 feet, a diagonally striped flag appears in the 10,000-foot window.
9. OFF INDICATOR WARNING FLAG - Flag appears across altitude readout when power is removed from altimeter to indicate that readout is not reliable.
10. 100-FOOT DRUM TYPE INDICATOR - Provides digital altitude readout in 100-foot increments between 0 feet and 1000 feet.
11. 20-FOOT INDICATOR NEEDLE - Indicates altitude in 20-foot increments between 0 feet and 1000 feet.
12. ALTIMETER SETTING SCALE - DRUM TYPE - Indicates selected altimeter setting in the range of 27.9 to 31.0 inches of mercury on the standard altimeter or 950 to 1050 millibars on the optional altimeter.
13. ALTIMETER SETTING KNOB - Dials in desired altimeter setting in the range of 27.9 to 31.0 inches of mercury on standard altimeter or 950 to 1050 millibars on the optional altimeter.

Figure 1. Cessna 400 Transponder and Encoding Altimeter
Operating Controls (Sheet 2 of 2)

SECTION 2 LIMITATIONS

There is no change to the airplane performance when this avionics equipment is installed. However, the encoding altimeter used in this installation does have a limitation that requires a standard barometric altimeter be installed as a back-up altimeter.

SECTION 3 EMERGENCY PROCEDURES

TO TRANSMIT AN EMERGENCY SIGNAL:

1. Function Selector Switch -- ON.
2. Reply-Code Selector Switches -- SELECT 7700 operating code.

TO TRANSMIT A SIGNAL REPRESENTING LOSS OF ALL COMMUNICATIONS (WHEN IN A CONTROLLED ENVIRONMENT):

1. Function Selector Switch -- ON.
2. Reply-Code Selector Switches -- SELECT 7700 operating code for 1 minute; then SELECT 7600 operating code for 15 minutes and then REPEAT this procedure at same intervals for remainder of flight.

SECTION 4 NORMAL PROCEDURES

BEFORE TAKEOFF:

1. Function Selector Switch -- SBY.

TO TRANSMIT MODE A (AIRCRAFT IDENTIFICATION) CODES IN FLIGHT:

1. Reply-Code Selector Switches -- SELECT assigned code.

2. Function Selector Switch -- ON.
3. DIM Control -- ADJUST light brilliance of reply lamp.

NOTE

During normal operation with function switch in ON position, REPLY lamp flashes indicating transponder replies to interrogations.

4. ID or XPDR IDENT Button -- DEPRESS momentarily when instructed by ground controller to "squawk IDENT" (REPLY lamp will glow steadily, indicating IDENT operation).

TO TRANSMIT MODE C (ALTITUDE REPORTING) CODES IN FLIGHT:

1. Off Indicator Warning Flag -- VERIFY that flag is out of view on encoding altimeter.
2. Altitude Encoder Altimeter Setting Knob -- SET IN assigned local altimeter setting.
3. Reply-Code Selector Switches -- SELECT assigned code.
4. Function Selector Switch -- ALT.

NOTE

When directed by ground controller to "stop altitude squawk", turn Function Selector Switch to ON for Mode A operation only.

NOTE

Pressure altitude is transmitted by the transponder for altitude squawk and conversion to indicated altitude is done in ATC computers. Altitude squawked will only agree with indicated altitude when the local altimeter setting in use by the ground controller is set in the encoding altimeter.

5. DIM Control -- ADJUST light brilliance of reply lamp.

TO SELF-TEST TRANSPONDER OPERATION:

1. Function Selector Switch -- SBY and wait 30 seconds for equipment to warm-up.
2. Function Selector Switch -- ON or ALT.
3. TEST Button -- DEPRESS and HOLD (reply lamp should light with full brilliance regardless of DIM control setting).
4. TST Button -- RELEASE for normal operation.

SECTION 5

PERFORMANCE

There is no change to the airplane performance when this avionic equipment is installed. However, the installation of an externally mounted antenna or several related external antennas, will result in a minor reduction in cruise performance.

