

Pilot's Guide to **FOREFLIGHT MOBILE**



ForeFlight
Intelligent Apps for Pilots™

54th Edition

Covers ForeFlight Mobile v9.4 on iPad

Introduction.....	19
iPad Tips.....	19
Setting-up ForeFlight Mobile	21
Planning a Flight	22
Planning a flight using the Flights form.....	22
Navlog, Briefing, Messages.....	23
Planning a flight on Maps using the Flight Plan Editor	24
Planning a flight on Maps using Touch.....	25
Planning a flight on Maps using Search.....	26
Scheduled Flight Search on Maps.....	28
Airports.....	30
About the Design	31
Finding an Airport using Search	31
Finding an Airport using Browse	32
Favorite Airports List	33
Recent Airports List.....	34
Favorite and Recent Airport Sync.....	34
Viewing Airport Weather.....	35
Model Output Statistics (MOS) Forecasts	36
Runway Winds.....	38
Viewing a Procedure	39

Swipe to Change Plates.....	40
Using Geo-Referenced Procedures.....	42
FBO Information	43
Fuel prices.....	43
Comments	44
Airport/Facility Directory (A/FD) or Canada Flight Supplement (CFS).....	45
Airport and Aircraft Flight Tracking	46
Maps	47
About the Design	47
Pinch, Zoom, and Pan	48
Changing Maps / Map Layers.....	48
Weather Layer Time Slider.....	56
Global Aeronautical Maps.....	57
Aeronautical Maps Features.....	58
Aeronautical Maps Symbols.....	60
Maps Settings	61
Map Touch	64
Smart Airway Labels	66
Airport popup.....	67
Weather Layer Color Coding	68
Attitude Indicator / Synthetic Vision (iPad only).....	70
IMPORTANT NOTICE: ATTITUDE INDICATOR DISPLAY	71

Stratus 2/2S Positioning.....	73
Calibrate the AI/SV display	73
Synthetic Vision required downloads.....	74
Finding an Airport, Navigation Aid, or Aircraft using Search.....	75
Airspace Information.....	76
Route Line	77
Working with the NavLog, Edit and Profile Views	77
Overview	77
Flight Plan Editor	79
Procedure Advisor.....	81
Reverse	89
Route Advisor	90
Route Editor.....	91
NavLog View	92
Profile View.....	93
Single-waypoint Search.....	99
Engaging the Moving Map.....	100
Track Up	100
Distance Rings	101
Glide Advisor™	103
Track Vector	105
Direct-To.....	106
Ruler	106

Viewing and Hiding the Instrument Panel	107
Using Favorite Routes	109
Using Recent Routes.....	109
Favorite and Recent Route Sync	109
Clearing a Route.....	110
Alerts.....	111
About The Design.....	111
Runway Proximity Advisor	111
Cabin Altitude Advisor.....	112
Traffic Alerts.....	112
TFR Alerts.....	112
Sink Rate.....	114
500' AGL	115
Device Disconnect.....	115
Destination Weather Frequency	116
New Flight Plan Loaded From Panel	117
Pack.....	118
About the Design.....	118
Pack for a Flight.....	120
iPad	120
iPhone.....	121

Sync.....	123
About the Design.....	123
Using Sync.....	123
Cockpit Sharing	126
About the Design.....	126
Using Cockpit Sharing.....	126
Plates.....	127
About the Design.....	127
About Plate Binders	128
Creating a Binder	128
Managing Plates.....	128
Plate Controls.....	129
NOTAM Advisor for Approach Plates and Airport Diagrams.....	130
FBOs on Airport Diagrams.....	131
Printing Plates From a Binder.....	132
Ensuring Your Plates Don't Expire	132
Plates and Taxi Diagrams on a Map.....	133
About the Design.....	133
Displaying a Plate on a Map.....	134
Changing or Hiding the Plate on a Map.....	135
Adjusting Plate Transparency	135

Track Logs	136
About the Design.....	136
Enabling Track Logging.....	136
Start/Stop Logging.....	136
Flight Time Instrument.....	137
Track Log Listing	137
Synchronizing Track Logs to other Devices.....	138
Viewing a Track Log on an iPad or iPhone	139
Sharing Track Logs	139
Exporting Track Logs to other Apps	140
Viewing Track Logs in ForeFlight on the web.....	141
Documents	142
About the Design.....	142
About Document Binders.....	143
Creating a Binder	143
Adding Documents from a Catalog.....	143
Document Syncing.....	144
Importing Documents from iTunes or other Apps.....	148
Viewing a Document.....	149
Searching in a Document	150
Adding and Removing Bookmarks.....	151

Managing Documents in a Binder.....	151
Deleting Documents from your iPad.....	152
Ensuring Your Documents Don't Expire.....	152
Annotating Plates and PDF Documents	153
About the Design.....	153
Types of Annotations	154
Adding and Editing Annotations.....	154
Choosing Annotation Color.....	155
Fill Color: Transparent or "No Fill"	156
Drawing/Ink.....	157
Text Box.....	157
Rectangle.....	158
Ellipse (Circle).....	159
Line	159
Polygon	159
Polyline.....	160
Sticky-note	160
Undo/Redo.....	161
Selecting Multiple Annotations.....	161
Copying and Pasting an Annotation	161
Deleting Annotations.....	161
Imagery	163
About the Design.....	163

Selecting a Collection.....	164
NATIONAL - Featured.....	164
CONUS WEATHER.....	166
GFS MOS.....	170
ADVISORIES.....	170
WINDS ALOFT.....	171
ICING	171
TURBULENCE.....	174
SATELLITE.....	175
DOPPLER RADAR.....	176
PILOT WEATHER REPORTS.....	176
Viewing an Image.....	177
Using Favorite Images	177
Send To.....	177
Flights.....	178
About the Design.....	178
Before Filing a Flight Plan	179
Choosing between FAA/Domestic and ICAO Flight Plans.....	180
Creating a Flight Plan.....	181
Creating an ICAO Flight Plan.....	181
Exporting an ICAO Flight Plan.....	181
Obtaining a Weather Briefing.....	182
Filing your Flight Plan (FAA/Domestic or ICAO).....	182

Flight Plan Acknowledgment Notification	182
Flight Notifications.....	183
Amending or Canceling a Leidos Flight Plan.....	185
Activating or Closing a Leidos VFR Flight Plan.....	186
Close VFR Flight Plan “PUSH” Alerts.....	187
Amending or Canceling a DUATS Flight Plan.....	187
Managing Flight Plans	187
Flight Alerts.....	188
ForeFlight Briefing	189
About the Design.....	189
Navigating the Briefing.....	190
Translated Text vs Raw Text.....	190
Briefing Sections	191
Adverse Conditions.....	191
Synopsis	192
Current Weather.....	192
Forecasts.....	192
NOTAMs	193
Miscellaneous.....	193
ScratchPads	194
About the Design.....	194
Open a ScratchPad.....	194

ScratchPad Templates	195
Change Pen Size, Color, Opacity	195
Undo/Redo.....	196
Clear ScratchPad Content.....	196
Edit a ScratchPad Name	196
Reposition ScratchPad Thumbnails	197
Send a ScratchPad.....	197
Delete a ScratchPad.....	197
More	198
Downloads	198
About the Design.....	198
Grouped Downloads	200
Select Data to Download	200
Downloading Data.....	202
Downloading in the Background.....	202
Keeping Current.....	203
Deleting Data Downloads	203
A Quick Tour of the Data Available for Download.....	204
Preflight Download Check	205
Troubleshooting Downloads.....	206
Accounts	208
About the Design.....	208
Viewing your Active Subscription	208

Purchasing or Renewing a Subscription in the United States.....	209
Purchasing or Renewing a Subscription in Canada	210
Signing In to your ForeFlight Account.....	210
Signing Out of your ForeFlight Account.....	211
Changing your Password or Email.....	211
Removing Devices from your Account.....	211
Providing a DUATS Account.....	212
Signing Out of your DUATS Account.....	212
Aircraft	214
Create or Edit an Aircraft.....	214
Basic Performance Profile.....	216
Delete Aircraft.....	216
Manage Aircraft for Multi-Pilot Accounts.....	217
Logbook.....	219
Checklist.....	220
Checklist Pro Migration	220
Setting Up Checklists	221
Editing Checklists.....	222
Using Checklists.....	223
Sharing Checklists.....	224
Weight & Balance.....	225
Settings.....	226
User Content.....	233
Importing User Content files.....	233

Deleting User Content.....	235
Sharing User Waypoints.....	235
Creating User Waypoints.....	236
Latitude/Longitude Formats.....	237
User Map Layers.....	238
User Charts.....	239
Track Logs.....	240
Devices.....	240
Location Disabled / Troubleshooting GPS position issues.....	240
About.....	242
Jeppesen.....	243
Purchasing Through ForeFlight (single-pilot accounts only).....	243
Linking an Existing Jeppesen Account in ForeFlight Mobile.....	245
Linking an Existing Jeppesen Account in ForeFlight on the Web.....	246
Using Jeppesen Terminal Charts in ForeFlight.....	247
Using Jeppesen Enroute Charts in ForeFlight.....	248
Apple Watch.....	251
Overview.....	251
Setting Up.....	251
Airports Page.....	253
Instruments Page.....	254
Timer Page.....	255
ADS-B Weather.....	256

Overview	256
ADS-B Weather Products	256
Status Information.....	257
Animated ADS-B Radar	258
ADS-B Tower Location on Map.....	259
ADS-B Traffic	260
Overview	260
IMPORTANT TRAFFIC NOTICE.....	260
Traffic Access in ForeFlight Mobile.....	260
Status Information.....	261
Traffic Symbols	261
Hide Distant Traffic Setting	263
Ownship ADS-B Out Information.....	263
Traffic Alerts.....	264
ForeFlight Connect.....	265
Overview	265
Scout	265
Connecting to Scout.....	265
Using Scout.....	266
ADS-B From Scout.....	267
Updating Scout's Firmware	267
Stratus ADS-B Receivers	268

Stratus Status Information	268
Stratus ESG (Stratus 1S/2/2S Only)	271
Stratus Replay (Stratus 1S/2/2S Only)	271
Stratus Flight Data Recorder.....	272
Recording a Track Log Using the Flight Data Recorder	272
Stratus Firmware Update.....	273
Garmin Connex	275
Pairing with Flight Stream.....	275
Using Connex	275
GPS and ADS-B from Connex.....	276
Sending a Route to Connex (requires Flight Stream 210 or 510).....	278
Getting a Route from Connex (requires Flight Stream 210 or 510)	279
Calibrating Flight Stream 210 AHRS	280
Garmin GTX 345	281
Connecting to GTX 345	281
Using GTX 345	281
GPS and ADS-B from GTX 345.....	282
Calibrating the GTX 345 AHRS	282
Garmin GDL 39	284
Connecting to GDL 39	284
Using GDL 39.....	284
GPS and ADS-B from GDL 39.....	285
Calibrating GDL 39 3D AHRS	286
L-3 Lynx	287

Connecting to Lynx.....	287
Using Lynx.....	287
GPS and ADS-B from Lynx.....	288
Avidyne IFD 550/540/440	289
Connecting to IFD 540/440.....	289
Getting a Route from IFD 550/540/440	289
GPS from IFD 550/540/440 and AHRS from IFD 550.....	291
uAvionix echoUAT & SkyEcho	292
Connecting to echoUAT & SkyEcho.....	292
Using echoUAT & SkyEcho.....	292
GPS and ADS-B from echoUAT & SkyEcho.....	293
Dynon SkyView.....	294
Configuring SkyView WiFi.....	294
Connecting ForeFlight and SkyView.....	294
Sending a Route to SkyView	295
Getting a Route from SkyView.....	297
GPS and ARHS data from SkyView.....	298
FreeFlight ADS-B.....	299
Connecting ForeFlight and FreeFlight RANGR.....	299
GPS and ADS-B data from FreeFlight RANGR.....	300
SiriusXM SXAR1	301
Connecting ForeFlight to the SXAR1	302
SXAR1 Available Weather Data.....	302
SXAR1 Status Information	304

SiriusXM Satellite Radio.....	305
Connecting a Bluetooth audio device to the SXAR1	306
SXAR1 Audio Controls.....	308
Baron Mobile Link/WXWorx.....	310
Mobile Link Available Weather Data.....	310
Mobile Link Status Information	311
Satcom Direct Router (SDR)	312
Connecting to SDR.....	312
Using SDR.....	312
GPS and Pressure Altitude from SDR.....	313
LogTen Integration.....	314
Flight Simulator Integration.....	315
Before Using a Flight Simulator with ForeFlight Mobile	315
X-Plane	315
Infinite Flight	316
Prepar3D/Flight Simulator X.....	318
Redbird	318
ELITE	318
AeroFly FS 2	318
Frasca	319
Sharing Flights	320
Twitter.....	320

Email.....	320
Weather Legends	321
Radar Legends (when from Internet)	321
Rain - Radar Intensity (dBZ) vs. Color.....	322
Mixed Rain/Snow - Radar Intensity (dBZ) vs. Color	323
Snow - Radar Intensity (dBZ) vs. Color	324
Four-color Radar - Radar Intensity (dBZ) vs. Color.....	325
Baron Mobile Link/WXWorx XM Radar Intensity (dBZ) vs. Color.....	326
Icing Legend (Internet & SXAR1).....	327
Turbulence Legends.....	328
Light Aircraft (takeoff weight of 15,500 lbs or less).....	329
Medium Aircraft (takeoff weight of 15,501 to 299,999 lbs).....	329
Heavy Aircraft (takeoff weight of 300,000 lbs or more).....	329
Surface Analysis Legend (Internet & SXAR1).....	330
Radar Legends (when from Internet)	331
PIREP Legend.....	331
Enhanced Satellite.....	332
Color IR Satellite	334
Learning More	336
Pilot's Guide Change History	337

Introduction

This pilot's guide provides an overview of ForeFlight Mobile and its capabilities on the iPad. After reading this guide, you will have the ability to:

- Plan flights quickly
- Gather preflight intelligence information efficiently, and
- Use ForeFlight Mobile to best support your type of flying.

This guide presumes a basic level of proficiency with general iPad use and navigation. If you are new to Apple iOS devices, including the iPad, you will want to *view the guided tours* available on Apple's website at www.apple.com/ipad/guided-tours/ as well as the iPad User Guide at support.apple.com/manuals/

iPad Tips

There are a few handy iPad features you'll want to know about when using ForeFlight Mobile:

❖ **Multiple Orientations:** The iPad supports portrait (tall) and landscape (wide) orientations. When you rotate an iPad from one orientation to another, an application typically alters its user interface to better take advantage of the space supplied.

❖ **Rotation Lock:** Having the screen content rotate when you rotate the iPad isn't *always* a good thing. Rotation lock is helpful for preventing Terminal Procedure rotation or accidental rotation in turbulence. Fortunately, you can choose when the screen rotates and when it doesn't. There are a few methods for locking the orientation of content on your iPad's screen:

Physical Switch: A physical switch is located immediately above the volume buttons on the right side of some iPad models (models without the switch are the iPad Pro, iPad Mini 4, and iPad Air 2). When switched on, this prevents an application from changing its orientation as you change the orientation of the iPad. On some iPads, this switch instead functions as a "mute" switch. You can change the function of this back to a "lock" switch by using the iPad's **Settings** application. Tap *General*, and use the options in the *Use Side Switch to:* section. If this section is not displayed, you may need to update your iPad's version of the iOS operating system to enable this.

iPad Soft-Lock: Swipe up from the bottom of the screen to open the Control Center and find the rotation lock soft-button. This method is not available if you have the physical slider switch set to manage screen lock.

ForeFlight Procedures Lock: ForeFlight Mobile also provides a soft-lock switch on the **Procedures** viewer for more flexibility.

❖ **Settings App:** The iPad includes a special application called Settings. Within Settings, you can modify the way the iPad and its applications behave. ForeFlight-specific settings are addressed in the Settings section of this guide. All ForeFlight settings are available in the *More* view of ForeFlight Mobile as well.

❖ **Brightness Control:** There is a brightness control accessible in iPad Settings app. It is also available for quick access in the Control Center by swiping-up from the bottom of the screen. This control is helpful for reducing brightness at night, or for dimming the screen during the day to preserve battery life.

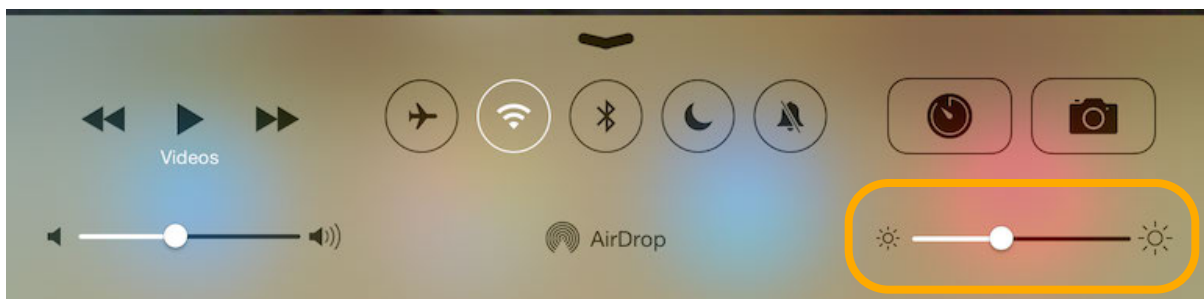

For night use, if the iPad brightness control set to full dim (slider all the way to the left) doesn't dim the screen enough, use the brightness slider in ForeFlight Mobile in the **More** view or at the top of the [Maps Settings](#) menu to dim the screen further. The ForeFlight brightness slider integrates with the iPad's brightness slider, but allows for additional dimming beyond the lowest setting of the iPad's slider.

Setting-up ForeFlight Mobile

First, download ForeFlight Mobile to your iPad, iPhone or iPod Touch from the Apple App store. See www.foreflight.com/support/getting-started for detailed instructions.

If this is your first time using ForeFlight Mobile on that device, you'll get a 30-day free trial of the data. The free trial includes all standard (not Pro) features, but you won't be able to "bulk download" charts and plates for different states.

You can purchase a subscription anytime at www.foreflight.com/buy.

IMPORTANT: If you have a subscription, follow these steps:

❖ **Sign in:** Your ForeFlight Mobile subscription is associated with your email address. This address **does not have to be the same** as the AppleID email address used in the Apple App store. Sign in on the More > Accounts tab (iPad) or the Menu > Account page (iPhone). See [Signing in to your ForeFlight account](#).

❖ **Choose Chart Data to Download:** See [Select Data to Download](#). Tap on **More > Downloads** (iPad) or **Menu > Downloads** (iPhone), then tap on the Country area(s) for which you have a subscription. For example if you have a US subscription, you would tap on United States. Choose the types of charts to download, then scroll down and select (tap) each state you want to download. Then tap the **<Downloads** button to go back to the Download status page, and tap the blue **Download** button to download the data.

❖ **Confirm Data Sync:** If you have previously used ForeFlight Mobile 6.2 or later on any device(s), your User Waypoints, Favorites (Routes, Airports, Plates, Imagery) and Recents (Routes, Airports, Plates Imagery) will automatically be loaded after you sign-in. If you have lots of User Waypoints, Favorites or Recents, it may take a few minutes for the data to load.

❖ **If using an iPad:** Tap on **Documents > Catalog** and choose any [documents](#) you would like to have in-flight. The Pilot's Guide is in the ForeFlight category; the FAA category has A/FD Supplementals, Legends, and FAR's and FAA Handbooks.

Before flying, be sure to complete the [pre-flight check](#), including Downloading Data, and [use Pack](#) to confirm you have charts, METARs, NOTAMs, TFRs and Fuel prices covering your route.

Planning a Flight

ForeFlight Mobile 9.1 introduces a form-based flight planning option on the Flights view, which replaces the “File & Brief” view. Form-based flight planning compliments and enhances the familiar Maps based Flight Plan Editor and touch planning options that are still available. You can start flight planning on either the Maps page or the Flight page, and easily transition between the two as needed.

If you have a Performance Plus subscription, please refer to the Performance Plus guide (available in the app in Documents > Catalog > ForeFlight) or online at <http://foreflight.com/support/performance/pdf> for additional details about the Performance Plus flight planning features.

Planning a flight using the Flights form

To start planning, enter a departure and destination (and alternate, if needed) then enter your desired route or choose one using [Route Advisor](#). Route Advisor provides ATC-cleared routes (if available) as well as Preferred, TEC, and Airway routes.

A dynamic map built into the Flights view allows you to see your route and overlaid composite radar. Tap on the map to expand it to an interactive “half-screen” mode, then tap the Back button in the top-left to return to the planning form.

Select the aircraft and desired performance profile, then tap the Altitude Advisor to see the effect of winds at different altitudes. The top row shows a route performance summary; the “Refresh” button updates the summary with the latest data.

Tap the “Briefing” button to generate a graphical weather briefing, and tap the “Navlog” button to create and email (or print) a detailed Navlog.

At any point in the planning process you can send a Flight to the Maps page by tapping the “Send to” button in the upper-right corner and

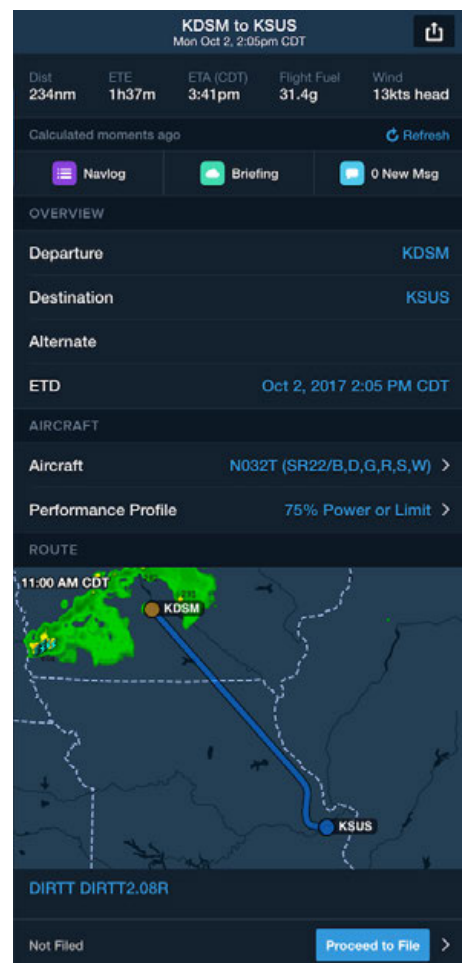

choosing Map. If you make further modifications on the Maps page, you can send them back to Flights by tapping the "Send to" button at the bottom-right of the Flight Plan Editor and choosing "Flights."

If planning a multi-leg trip, use the "Add Next Flight" button at the bottom of the planning form to create a new flight that retains the most important details from the previous one, making it easy to plan consecutive trip segments. Add Next Flight sets the destination airport of the previous flight as the departure airport of the new flight, and sets the new flight's ETD to 30 minutes after the ETA of the previous flight, if that time has not already passed. Add Next Flight preserves the first flight's aircraft and performance profile, and if you have a Performance Plus subscription it will also use the same payload details and fuel policy as the previous flight.

When you have finished planning, tap the "Proceed to File" button to file a flight plan.

Navlog, Briefing, Messages

Tap the "Navlog" button to view a detailed Navlog, including leg times, winds, and fuel burns; winds at altitudes above and below your planned altitude; and airport frequencies. The Navlog can be printed (on an available AirPrint printer) or emailed. You can also view the Navlog on a computer by signing-in at plan.foreflight.com and clicking on the Flights menu. Navlogs generated on the web will automatically become available on mobile as part of ForeFlight's [Sync](#) system, and vice versa.

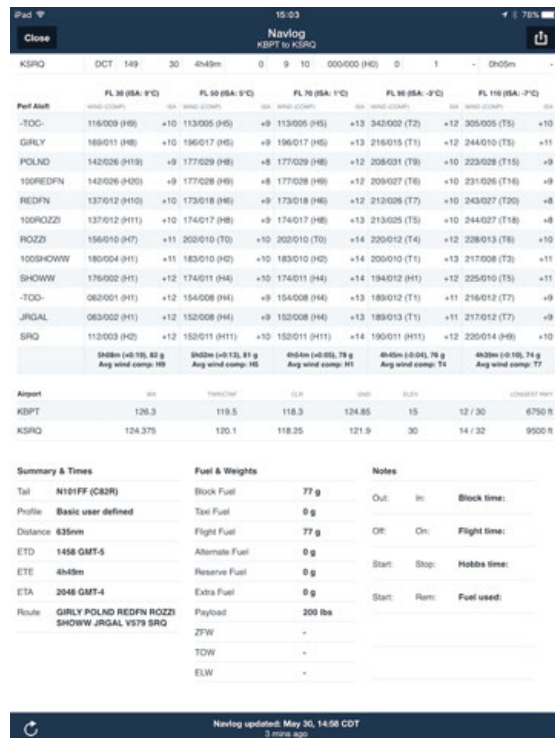

Tap the “Briefing” button to request a ForeFlight briefing. To update an already-received Briefing, open the Briefing then tap the circular arrow “Refresh” button in the lower-left corner of the briefing. For more details about the briefing, refer to the [ForeFlight Briefing](#) chapter later in the guide.

If a message is received related to TFRs, airport/runway closed/unsafe NOTAMs, urgent PIREPs, SIGMETs, Convective SIGMETs, AIRMETs, Center Weather Advisories (CWAs), and Severe Weather Watches/Warnings that affect your filed route, “# New Msg” button will update to show the number of messages. Tap the button to view any messages received for a filed plan.

For more detailed information about filing flight plans, refer to the [Flights](#) chapter later in the guide.

Planning a flight on Maps using the Flight Plan Editor

Tap the “FPL” button in the menu bar to display the Flight Plan Editor, then tap on the “Edit” tab and type the Airport IDs, NAVAIDs, Airways, etc... that you want to be part of your route. You can use a combination of typing and Touch (eg: rubber-banding a route by touch-holding on a route line and dragging it to the desired location) to plan the route.

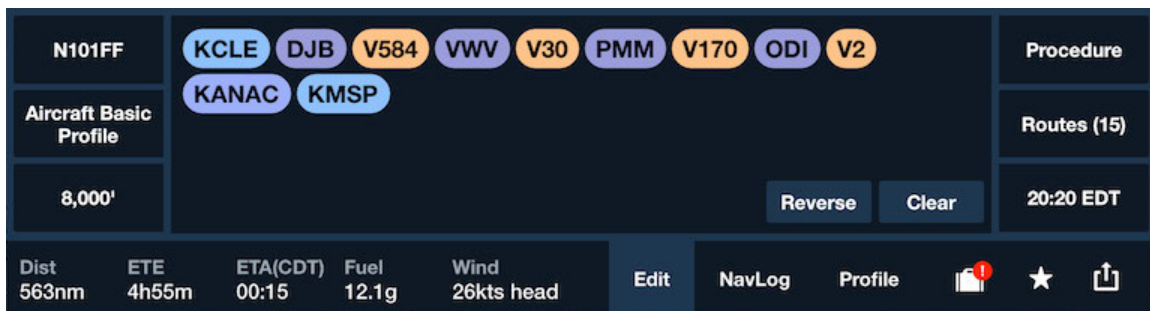

Use the buttons on the left side of the Flight Plan Editor to choose the aircraft, performance profile and to open the Altitude Advisor, and use the buttons on the right side to open [Route Advisor](#), to pick a Departure, Arrival, and/or Approach, and to set the Estimated Time of Departure (ETD). See the [Edit View](#) section later in this guide for additional details.

Planning a flight on Maps using Touch

You can also create or edit a route using a single finger with ForeFlight Mobile's "Touch Planning." Touch Planning is based on touch-and-hold gestures on the Map: place your finger on a waypoint or other location on the map and hold it there for a second. A dialog will appear asking you to specify which location near your touch point should be used.

❖ **Add** a waypoint to your current route, or **start a new route**: Touch-and-hold until a pop-up is displayed. Then, select the desired waypoint in the pop-up by tapping the name. If you already have a route on the map, the new waypoint will be added to the end.

❖ **Remove** a waypoint from your current route: Touch-and-hold on the waypoint. Tap the **Delete** button in the top right of the pop-up.

❖ **Insert** a waypoint in the middle of an existing route leg: Touch-and-hold on the route leg line until it turns blue. Then, keeping your finger on the screen, drag to the location you want to add. Remove your finger from the screen and select the desired waypoint from the pop-up view by tapping its name. Or tap **More** to see additional options: **Direct**, **Add to Route**, or **Details**.

The pop-up view that appears as part of touch planning allows you to select from a list of locations near your touch point, sorted by distance. The list shown is filtered by *All* (which includes airspaces), *Airports*, *Nav* (VORs, NDBs), and *Waypoints* (intersections and user waypoints). To change the filter mode, tap the buttons in the bottom of the pop-up view.

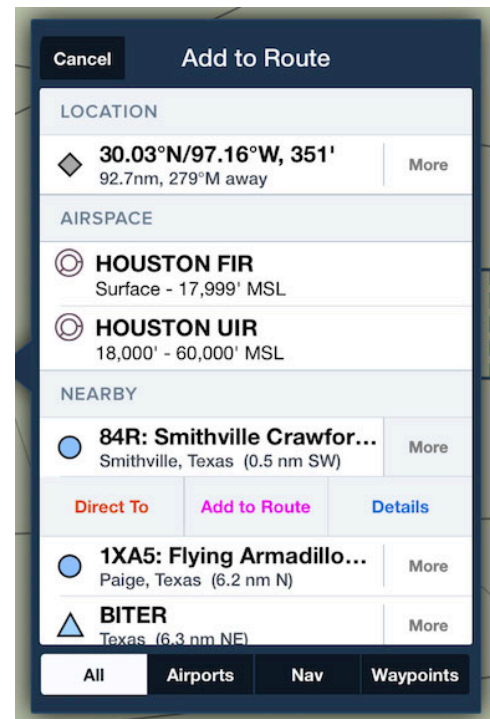

To cancel a touch planning operation, tap the **Cancel** button that appears in the pop-up view or tap the map outside the pop-up view.

When Adding a waypoint using touch, the pop-up window shows an icon next to the name to help identify the type of waypoint:

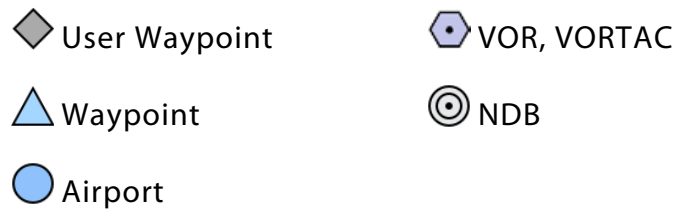

Tap the “**More**” button next to an entry in the pop-up to show additional options for that entry (see following example for 84R):

Tap the orange **Direct To** to make a new route direct-to that airport or waypoint from your present position.

Tap the magenta **Add to Route** to add that airport or waypoint to the end of the route.

Tap the blue **Details** to see that airport’s or waypoint’s detail view.

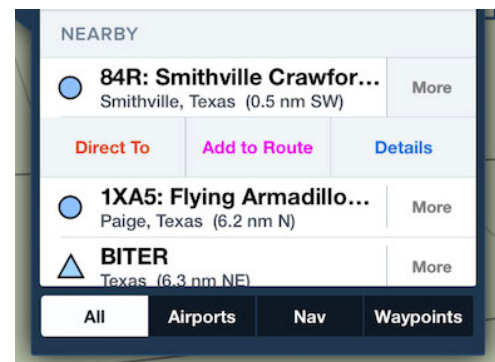

Planning a flight on Maps using Search

Create a route across any of the available maps by typing in multiple identifiers in the *Search* box, separated by a space, in the order in which you will visit them. You can also search for an aircraft’s tail number or call sign to see a list of scheduled flights that can be loaded into ForeFlight.

When typing a search, look for the hints that appear underneath the search box. These hints provide example route searches that act as great reminders for quickly visualizing your route. Any of the search options specified in the [“Finding an Airport or Navigation Aid using Search”](#) section are

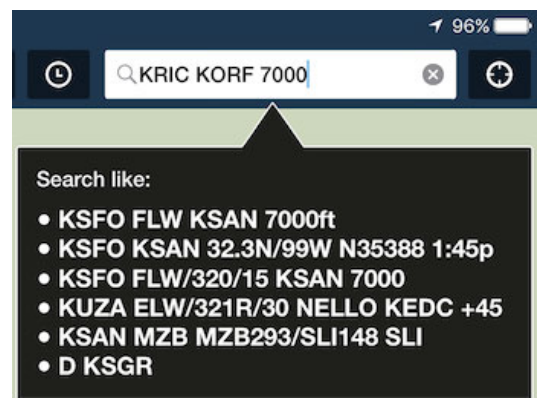

supported as route waypoints. Additionally airways, arrivals and departures are supported, as well as any custom waypoints you have created.

Your current location, if it can be determined, can be used as the origin for your route, as in the last example in the screenshot above: D KSGR. ForeFlight will replace the "D" with the coordinate for your position.

Entire airways can be viewed on the map by searching for just the airway identifier, for instance: V16. Airways can also be used in a route, just as ATC would issue them. For example: NIKOL V244 ILC. ARINC 424 coordinates (ex: 5275N) can also be entered in the Search box or Route Editor.

DPs and STARs (as well as associated transitions) are also supported in a route. If the DP or STAR requires a runway input, ForeFlight Mobile will prompt you for one and provide an example. When briefing and flying these procedures, it is critical to *always* refer to the official arrival/departure plate from the Airport view as the ForeFlight Maps view is *not able to show heading vectors, altitude info, and certain other details you'll need*.

When building a route in the search box you can also provide basic performance information about your aircraft. These can be in any order, but must come after the route waypoints. These include:

- ❖ **Altitude** in feet.
- ❖ **KJFK KSFO** - this is a simple direct route from NY to San Francisco.
- ❖ **D KSFO** - this is a direct route from your current position to San Francisco.
- ❖ **KJFK FLW 32.3N/99W** - this is a route from NY to the FLW VOR to a lat/lon waypoint.
- ❖ **KSFO FLW/320/15** - this is a route from KSFO to a point on the 320 radial 15nm from FLW VOR. If a VOR is not given as the reference waypoint, then the directional information is assumed to indicate a bearing, not a radial. Enter "M" after the bearing to position the point on the magnetic bearing; enter "T" after the bearing to position the point on the true bearing.
- ❖ **KCLT RDU J209 ORF J121 SIE.CAMRN4 KJFK** - this route includes multiple jet airways and an arrival.
- ❖ **KUZA KOSH 8000ft** - this is a route from Rock Hill to Oshkosh at an altitude of 8,000'. The selected aircraft's performance profile is used because fuel burn and true airspeed cannot be entered in the Search box.
- ❖ **KJFK YQM V311 YQX 5050N 5330N 5315N EGLL** - This hypothetical route from JFK to London Heathrow uses ARINC 424 coordinates between Gander and

Heathrow. See http://code7700.com/arinc_424_shorthand.html for additional information.

A route search can also include a *tail number* of an aircraft setup in the **More > Aircraft** view. When that aircraft has performance data it will be automatically used.

Lastly, you can also indicate a departure time in your route search; ForeFlight will use this time to incorporate the proper winds aloft forecasts into your time and fuel usage calculations. If you don't provide a time, ForeFlight Mobile assumes you are departing ASAP. You can include the departure time as a specific time or as a time relative to *now*, as a local time or Zulu time, like this:

❖ **KUZA KOSH 8000 1315Z** - The route details will be calculated for conditions starting at 1315Z. The time can be designated in Zulu time, as in the example, or local time, such as: **13:15**, **1:15p**, **1:15pm**, **1:15a**, **1:15am**, or **1:15** (with no am/pm given, ForeFlight will assume you desire the next upcoming 1:15).

❖ **KUZA KOSH 8000 +60** - The route details will be calculated for conditions starting 60 minutes from now. This relative time *must* begin with a + and may be specified in minutes, hours, or a combination; **+60** or **+60m** for minutes, **+2h** for hours, **+2:30** for 2 hours 30 minutes.

A route entered in Search will automatically be transferred to the Route Editor. If you enter a new route in the Search box it will replace the route in the Route Editor. To clear the current route from the Search box, tap the "X" in the Search box. To clear the route from the Route Editor, change to the Edit view and tap the Clear button, then tap "Clear All."

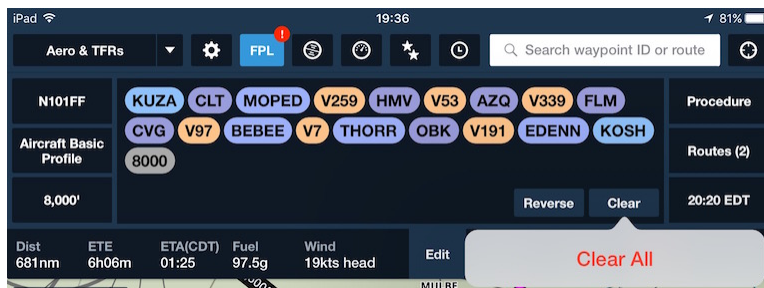

Scheduled Flight Search on Maps

You can use the Maps view search bar to see recent and upcoming flights for an aircraft and them into the Route Editor. Search by tail number (e.g. N12345), call sign (e.g. NGF345), or commercial flight number (e.g. SWA44). ForeFlight searches

FlightAware for any flights that are either currently enroute or set to depart in the next 24 hours and displays those flights in a list. Each flight listed includes the departure and destination airports, the filed altitude, the departure time, and the filed route. Tap on a flight to load the route and altitude into ForeFlight's flight plan editor.

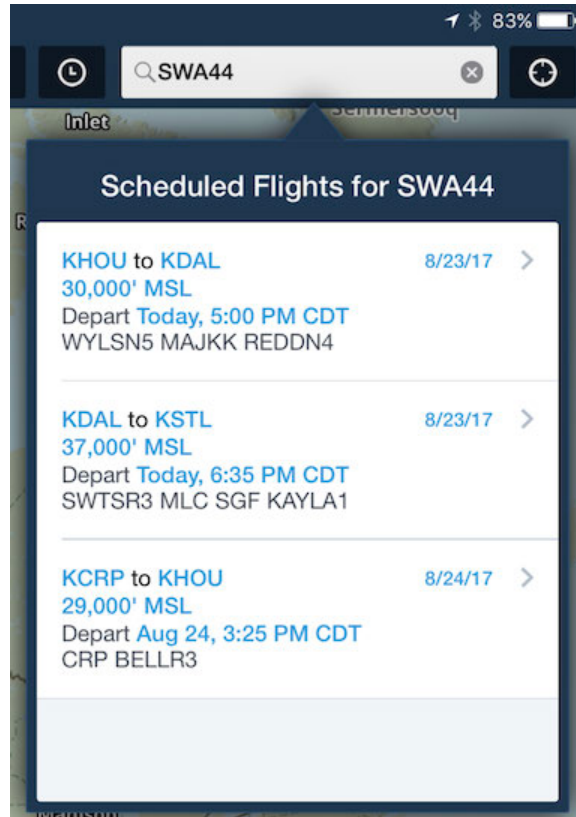

Airports

The *Airports* view displays airport information, frequencies, airport thumbnail diagrams, taxi diagrams, terminal procedures, service provider details, fuel prices and terminal area weather for over 20,000 airports worldwide.

Buttons located on the *Airports* view menu bar will help you find airports near the current airport, find airports near your current position, display the airport's location in the *Maps* view, and add or remove an airport to your *Favorites* list.

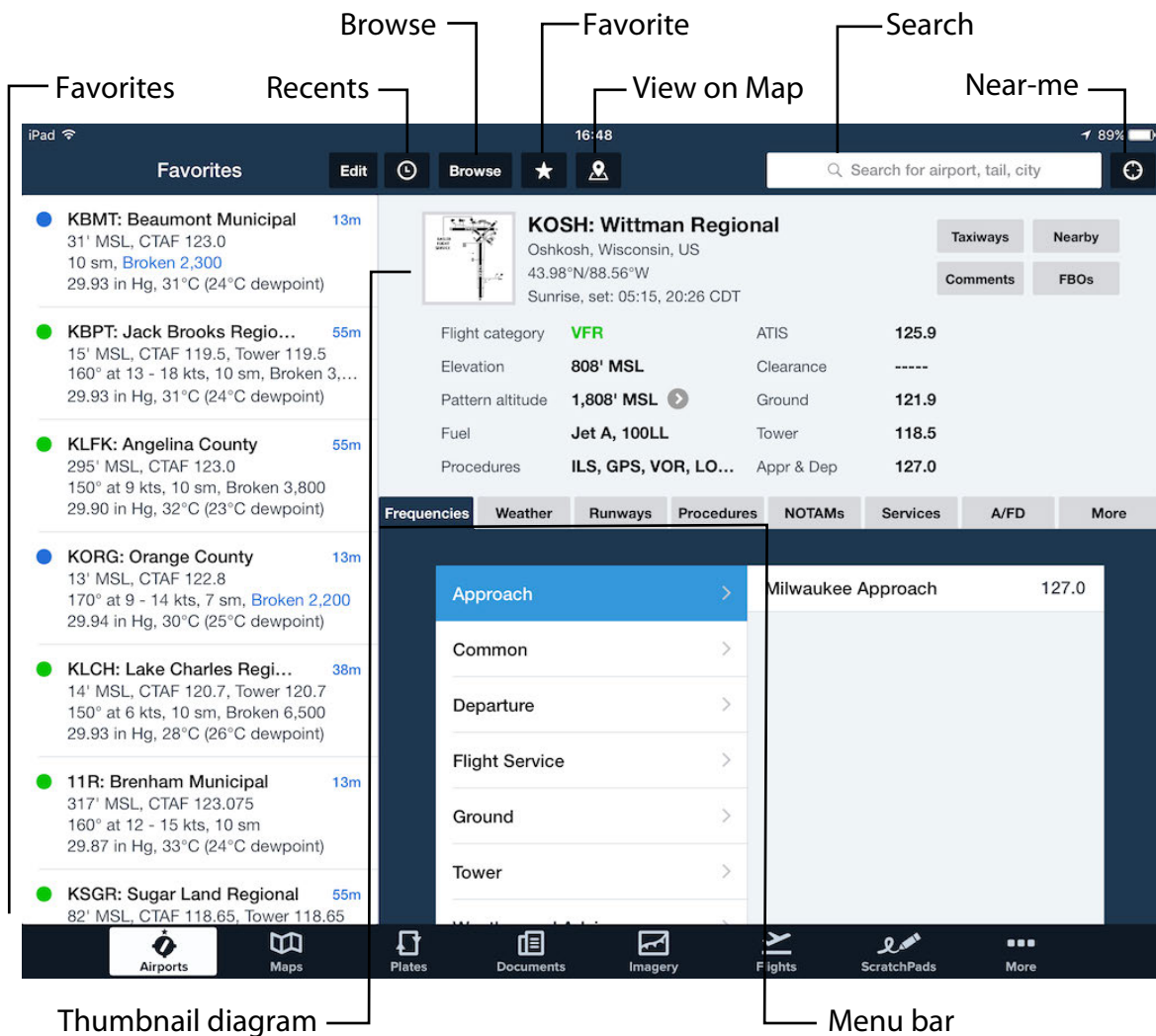

About the Design

The *Airports* view is designed to fill the whole screen, reducing scrolling and the effort required for your eyes to lock on to important airport information. The colors selected reduce brightness, draw attention to the top half of the page, and help highlight critical information.

Airport Detail information is displayed on the top half of the Airports view. Refer to this portion of the view when preparing to taxi or when approaching an airport, as it contains elements such as the current flight rule; field elevation and pattern altitude; automated weather frequencies, and controller frequencies.

Additional information from one of the eight available lower views is displayed in the bottom half of the screen. There are views for airport related frequencies, current and forecast weather, runway details, terminal procedures, notices to airmen, airport services, the Airport/Facility Directory entry, and supplemental airport information.

Finding an Airport using Search

Search is a useful method of finding information and creating flight plans within ForeFlight Mobile. Find airports by entering a search term in the search box, then tapping the 'Search' button displayed on the iPad's on-screen keyboard.

Valid search strings include Federal Aviation Administration airport identifiers (three-letter identifiers), International Civil Aviation Organization identifiers (four-letter identifiers), city name, or keyword.

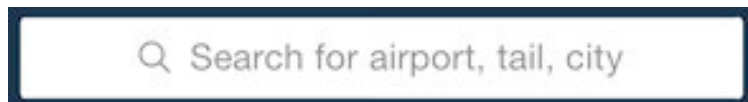

If ForeFlight doesn't find an instant match for the search term used, a list of close matches will appear.

Example Searches:

- ❖ **KJFK** - immediately displays airport information for Kennedy Int'l.
- ❖ **CDG** - immediately displays airport information for Charles De Gaulle.
- ❖ **Kennedy** - produces a list of all airports with "kennedy" in the airport or city name.
- ❖ **N35388** - returns aircraft information for the tail number N35388, including a link to FlightAware.com to track that aircraft's flights.
- ❖ **KXIH** - shows the METAR and related info for the KXIH weather station

Finding an Airport using Browse

The **Browse** button on the *Airports* view menu bar allows browsing airport listings by country and region. Search is the preferred method for locating airports, but Browse is a helpful option for locating an airport using the same State/City hierarchy you may already be familiar with from using Airport/Facilities Directories.



Tap the **Browse** button to display the *Airports* List. Use the 'A - Z scroller' on the right hand side of the Airports List to move forward and backwards quickly through the list. Tap the *All Countries* tab at the bottom of the airports list to view airports outside of the United States.

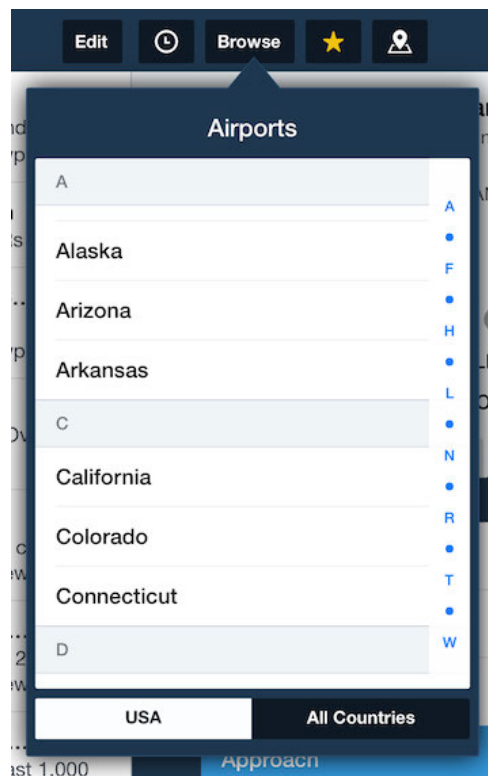

Favorite Airports List

Use the Favorites list to store frequently visited airports, area airports, and airports for upcoming flights. Having a nicely populated list of favorite airports makes scanning airport conditions a snap.

While viewing an airport, tap the single star button on the Airport view menu bar to add the airport to your Favorites list. Tap the button a second time to remove the airport from your Favorites list.



When in landscape mode, the Favorites List is displayed on the left side of the screen. When the iPad is in portrait mode, tap the double-star button on the Airports View menu bar to display the Favorites list. While the Favorites list is visible, tap any airport listed to display that airport's full information.



Tap the Edit button in the top-right corner of the Favorites list to reorder or remove airports. Reorder an airport by touch-holding on the stacked lines to the right of the airport, then sliding it up or down in the list. Remove an airport by tapping the red circle to the left of the airport and tapping the Delete button that appears. Tap Done to exit Edit mode.

Airports can also be deleted outside of Edit mode by swiping left across the airport to reveal the Delete button.

Each airport in the Favorites list displays the most recent weather information for the airport (if available).

Information displayed includes the current flight rule, observation age, wind speed and direction, ceiling, barometric pressure, temperature, and dew point. Weather warnings (e.g., fog, thunderstorms, cumulonimbus clouds, lightning, mist) - are displayed and highlighted in red when present. ForeFlight Mobile automatically checks for updated weather observations every minute. If a more current observation is available, it is downloaded immediately and the display is updated.

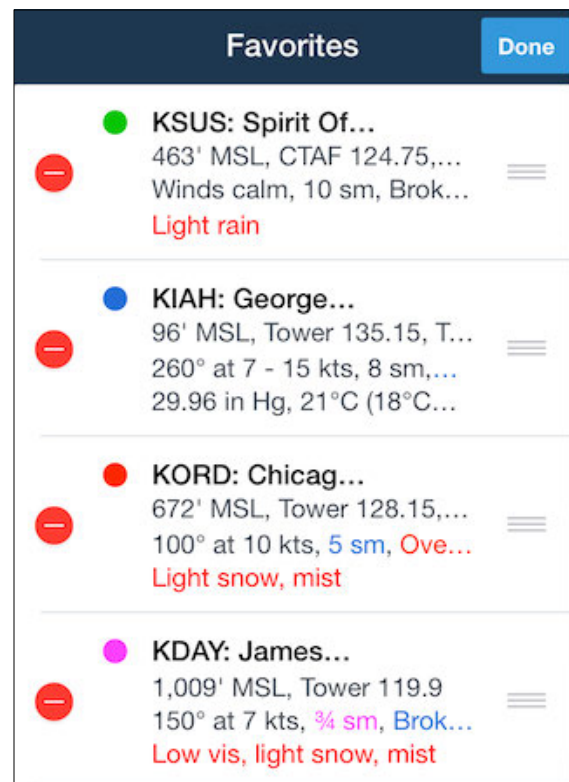

ForeFlight uses the following convention for conveying the airport's current Flight Category:

Green	VFR
Blue	MVFR
Red	IFR
Magenta	LIFR

Recent Airports List

Tap the history button to display the Recents list. The Recents list displays the last twenty airports viewed in the order they were viewed.



To remove airports from the Recents list, there are two methods available: *clear* and *swipe-to-delete*. Tap the **Clear** button to remove *all* airports from the list. To remove a single entry from the Recents list use the standard Apple 'swipe-to-delete' function: swipe your finger across the airport, then tap the red "Delete" button.

Favorite and Recent Airport Sync

Changes to your Favorite and Recent airports, including adding, removing and changing the order of Airports, are automatically synchronized to each device that is signed-in to your ForeFlight Mobile account. For more information, see the [Sync chapter](#).

Viewing Airport Weather

Current Flight Category and a summary of weather (METAR) are shown for each airport on the [Favorite Airports](#) list. Tap the “Weather” tab to view detailed weather data for the selected airport, including METAR, TAFs, Model Output Statistics (MOS) forecasts, the Forecast Discussion for that area (US only), and Winds and Temperatures aloft with calculated difference from ISA (International Standard Atmosphere). Scroll down to see future forecasted TAFs and Winds Aloft.

KCNO: Chino
Chino, California, US
33.97°N/117.64°W
Sunrise, set: 6:31 AM, 4:43 PM PST

Taxiways Nearby
Comments FBOs

Flight category	VFR	ATIS	125.85
Elevation	650' MSL	Clearance	-----
Pattern altitude	1,400' MSL	Ground	121.6
Fuel	100LL, Jet A	Tower	118.5
Procedures	ILS, GPS, VOR, LO...	Appr, Dep	135.4, 135.4

Frequencies Weather Runways Procedures NOTAMs Services A/FD More

METAR	VFR 7m ago
TAF	KCNO 232253Z 23011KT 10SM FEW200 26/01 A2991 RMK AO2 SLP125 T02610006
MOS	Time 4:53 PM CST
Forecast Discussion	Winds 230° at 11 kts
Winds Aloft	Visibility 10 sm
	Clouds (AGL) Few 20,000'
	Temperature 26°C (78°F)
	Dewpoint 1°C (33°F)
	Altimeter 29.91 in Hg

The forecast Temperatures Aloft at different altitudes are colored based on temperature range:

- Grey** Above +2° C
- Magenta** From +2° C down to -25° C
- Tan** Below -26° C

Model Output Statistics (MOS) Forecasts

Model Output Statistics (MOS) forecasts are derived from the output of numerical weather prediction models. An automated process developed by research meteorologists at NOAA, MOS takes the "raw" model forecast and uses a statistical approach to produce an objective site-specific forecast. For most stations, MOS forecasts are updated hourly for the first 24 hours, then updated every six hours from 25 hours to 3 days in the future. The new forecast is ordinarily available at 30 minutes past the hour.

IMPORTANT: MOS should ONLY be used as a supplemental product for enhanced situational awareness and is not meant as a substitute for official NWS forecasts.

While TAFs provide the official forecast for over 660 civilian airports throughout the US and its territories, MOS provides weather guidance for over 2000 airports including some military air bases.

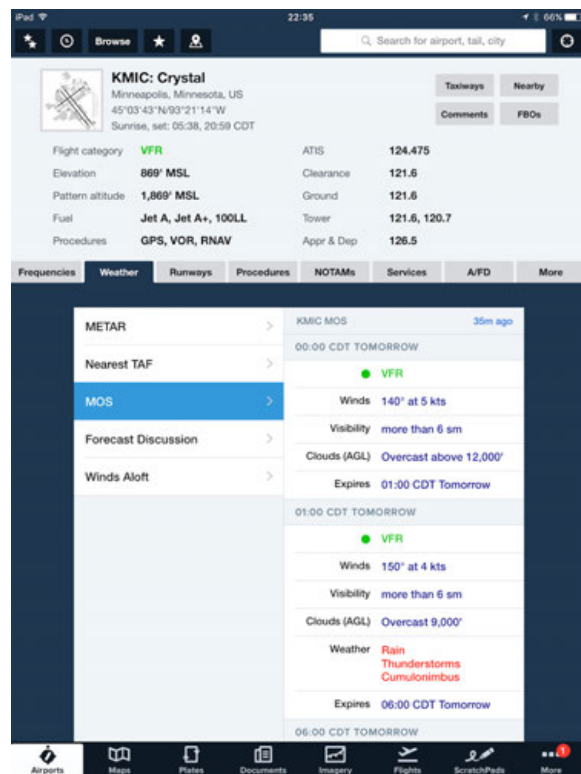
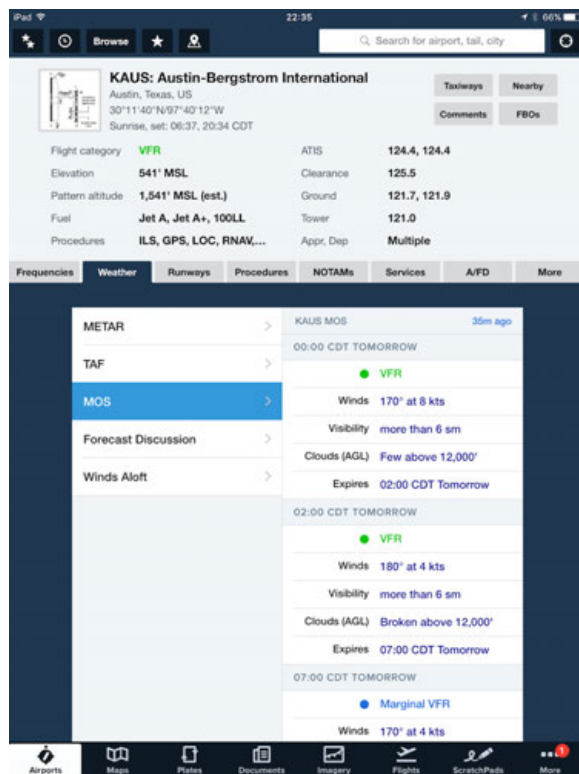

MOS builds on the original forecast model by taking into account a historical record of observations at forecast points (such as airports), removes any known systematic model biases, and quantifies any uncertainty (like precipitation or thunderstorm chances) into probabilistic forecasts. MOS also transforms the model data into sensible weather elements basic to aviation such as sky cover, ceiling

height, visibility, wind speed and direction, the probability of precipitation, and the precipitation type.

MOS is a point forecast similar to a TAF. That is, MOS is valid at the station (airport) and should not be used as zone or area forecast. Pilots should use MOS in a similar way they may use a TAF, keeping in mind that TAFs are constructed by highly trained meteorologists and will ordinarily be more accurate than a MOS forecast for the same airport. Although MOS cannot be used as a forecast for dispatch to the airport or for IFR alternate requirements as required by FAA regulations (use TAFs and the area forecast (FA) for this purpose) they are useful for getting a picture of likely weather at airports without a TAF, and for getting a more recently updated forecast for airports that do have a TAF, since MOS are updated hourly.

The use of "Nearest MOS" is provided strictly for convenience. Keep in mind that a MOS forecast for an airport that is 20 miles away, for example, may not be representative of the forecast for the intended airport.

Despite its advantages, the MOS has some **important limitations vs. TAFs**:

- ❖ MOS is only available for US airports and some airports in US territories.
- ❖ MOS forecasts are never amended.
- ❖ MOS does not predict temporary conditions.
- ❖ MOS cannot forecast multiple cloud layers.
- ❖ MOS does not predict specific cloud layers above 12,000' AGL.
- ❖ MOS cannot forecast weather in the terminal area's vicinity (e.g., showers, fog).
- ❖ MOS cannot forecast precipitation intensity and cannot distinguish between rain and drizzle.
- ❖ MOS cannot distinguish between freezing rain, freezing drizzle and ice pellets. so if any is present, it just says "Freezing Precipitation."
- ❖ MOS cannot predict variable winds.
- ❖ MOS cannot forecast non-convective low level wind shear (LLWS) or no significant weather (NSW).

Runway Winds

Tap on the Runways tab to view the preferred runway based winds reported in the last METAR received by ForeFlight Mobile. Headwinds are indicated by a green arrow and tailwinds by a red arrow in the first column. The first column assumes the runway heading is straight up & down, and the direction of the arrow reflects the relative direction of the winds when flying that runway heading.

The magnitude and direction of the crosswind are shown next to the grey arrow in the middle column. The far right column shows the magnitude of headwind or tailwind.

Remember that Runway heading is listed in Magnetic, while Wind direction is True. ForeFlight automatically applies the current Magnetic Variation when calculating the wind components. You can see the Magnetic Variation on the Airports page "More" sub-tab, under Features.

In this example, the most recently received METAR for KPMP reports the winds are from 50° at 8 knots. This means that the wind on Runway 10 is a headwind from the left: the resulting left crosswind component is 6 knots and the headwind component is 5 knots.

Wind direction relative to runway
Green = **Headwind**
Red = **Tailwind**

Crosswind component from direction of arrow

Headwind or tailwind component on runway

Current Winds

Runway	Dimensions	Surface	Wind Components
06 - 24	4,001' x 150'	Good asphalt	
10 - 28	3,502' x 100'	Good asphalt	Rwy 10 → 6kt ↓ 5kt
15 - 33	4,918' x 150'	Good asphalt	

WINDS: 050° at 8 kts (45m ago)

Tap on each runway in turn to view the expected headwind and crosswind components for that runway.

Viewing a Procedure

Terminal Procedures include Standard Terminal Arrival Routes (STARs), Departure Procedures (DPs), and approach plates. These are all accessible from the *Airports* view. Use the search or browse methods of finding an airport, then tap the **Procedures** tab located on the segmented menu bar in the middle of the *Airports* view. Depending on the procedures available for this airport, several types of procedures may be displayed according to type (e.g., Arrival, Departure, Approach). Takeoff minimums and alternate minimums can be found in the Departure and Arrival tabs, respectively. Custom procedures can be added using ForeFlight Mobile's *Bring Your Own Plates* feature. For information about using BYOP, see: www.foreflight.com/support/byop

Procedures are organized by their type in order to reduce scrolling. Procedures are saved to the device in one of two ways:

❖ **Downloads View** (bulk downloading procedures): Using the *Downloads* view allows bulk downloading of procedures for one or more regions for access when offline. This is the preferred and most efficient method for ensuring you'll have the procedures you need, whether or not you're online when it's time to view them.

❖ **On-demand** (downloading procedures one at a time): If you have not previously downloaded a procedure, tap a procedure name to download it immediately. This download method requires an Internet connection and thus will be unavailable while in flight. For this reason, ForeFlight recommends either using the bulk download functionality described above, or using this on-demand method while on the ground to ensure you'll always have the procedures you need while in flight.

Procedures are marked as **Saved** or **Not Saved**. Procedures marked *Saved (in green)* are stored locally on your iPad and are available when offline. Procedures marked **Not Saved** are **NOT stored** on your iPad and must be downloaded by viewing them or by using the Downloads view to download that region's terminal procedures in bulk.

Airport	>	NOT SAVED ILS or LOC Rwy 36	Map
Departure	>	NOT SAVED LOC/DME BC Rwy 18	Map
Arrival	>	SAVED NDB Rwy 36	Map
Approach	>	SAVED RNAV (GPS) Rwy 09	Map
		SAVED RNAV (GPS) Rwy 18	Map

From the **Procedures** tab, touch a procedure's name to display the ForeFlight procedure viewer. The procedure viewer includes buttons for: accessing a list of recently viewed procedures, [sending a plate to the Map](#) (if you have a Pro, Pro Plus, or Performance Plus subscription) printing a procedure, adding a procedure to your current Plates binder, and locking the procedure.

ForeFlight Mobile's **Lock** button disables touch interaction (zooming and scrolling) with the terminal procedure viewer, which minimizes the risk of accidental closure when in turbulence. It also disables the automatic rotation that would normally occur when the iPad is turned. The lock button can also, optionally, disable all buttons on the screen, including those that change views. That feature is configured in Settings.

Multi-page procedures can be viewed by sliding pages left or right with a single finger.

To print the plate, tap the **Send To** button in the upper toolbar and choose "Printer." An AirPrint capable printer is required. For more information about this requirement, see:

support.apple.com/kb/HT4356

Tap the **Rotate** button  in the upper toolbar to rotate the plate clockwise 90 degrees per tap.

Note: Procedures are also available directly from the [Plates](#) view.

Swipe to Change Plates

When viewing a plate from the Airports page or the Plates page (including in a binder) you can quickly change between plates by **swiping three fingers** from Right to Left (or Left to Right).

When viewing plates at an Airport, swiping from Right to Left with three fingers will display the next Procedure in that airport's list and swiping from Left to Right will display the previous Procedure in that airport's list.

When viewing plates in a binder on the Plates page, swiping from Right to Left with three fingers will display the next Procedure in the binder and swiping from Left to Right will display the previous Procedure in the binder.

In either case the lists do not "wrap around" so when you get to the end of the list, additional swipes in the same direction will not take you to the end (or beginning) of the list or binder.

IMPORTANT: The “Zoom” Accessibility option (in Apple Settings, General, Accessibility) must be OFF for plate swiping to work. If the “Zoom” Accessibility feature is ON, swiping with three fingers will not change between plates.

Recents Annotation Rotate Add to Binder
 Close Send to Soft-lock

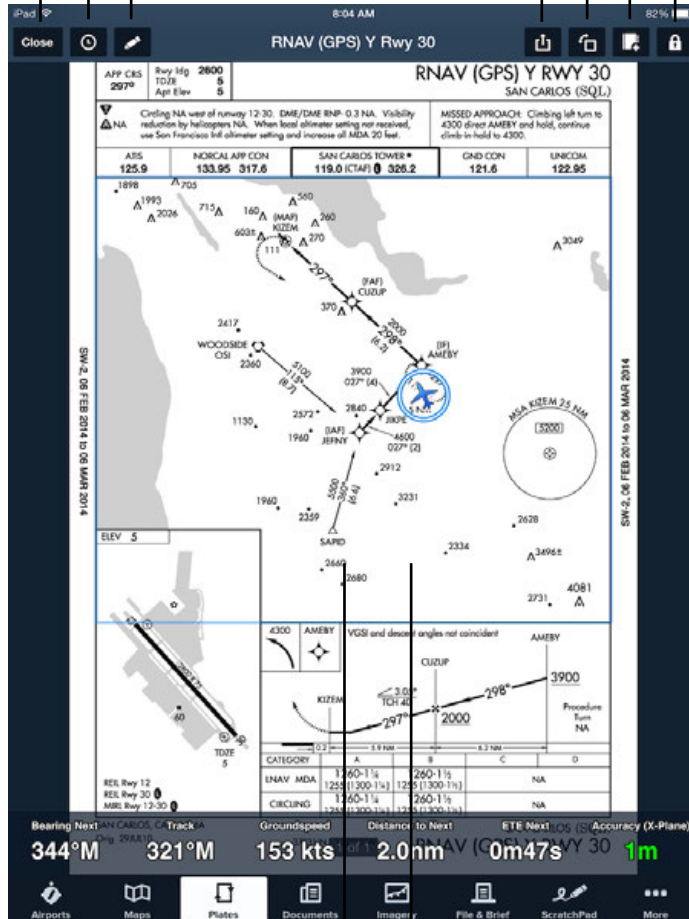

Instrument Panel
 Tap to hide/show Instrument Panel & menu

Touch-hold, then release to show Annotation menu, or tap Annotation button in Menu bar

NOTE: Displaying the Instrument Panel and aircraft position on a Plate requires a ForeFlight Pro, Pro Plus, or Performance Plus subscription. Basic and Basic Plus subscriptions do not show the Instrument Panel on the Plates page.

Using Geo-Referenced Procedures

Geo-referencing is an optional feature that requires a ForeFlight Pro, Pro Plus, or Performance Plus subscription. Go to www.foreflight.com/buy or the Accounts view to learn how to purchase or upgrade your subscription.

Most instrument procedures can be geo-referenced. This allows ForeFlight Mobile to display the aircraft's position on the procedure.

Only approach plates and taxi diagrams are geo-referenced; STARs/DPs are not drawn to scale and so cannot be geo-referenced. But using the "Procedure" button on the Flight Plan Editor you can add the points on the SID/STAR to your route.

When a geo-referenced FAA procedure is displayed, a blue square is drawn around the geo-referenced area (this is not the case with geo-referenced Jeppesen procedures). This is the only area of the plate in which your aircraft will be shown. Note that some plates are only drawn to-scale in the center portion - if your aircraft's location is shown outside that area it is positioned based on the scale of the center area and must *only* be compared to elements within that center area.

Until GPS data senses movement and provides a track over the ground, position is indicated using a small blue dot. Once your aircraft starts moving, the aircraft icon selected in ForeFlight Mobile settings is shown. Much like the *Maps* view, the aircraft speed, track, etc. is displayed at the bottom of the view. Tap an item in the Instrument Panel to change it. Geo-referenced approach plates and taxi diagrams can now also be displayed on the Map page, see the [Plates on a Map](#) section.

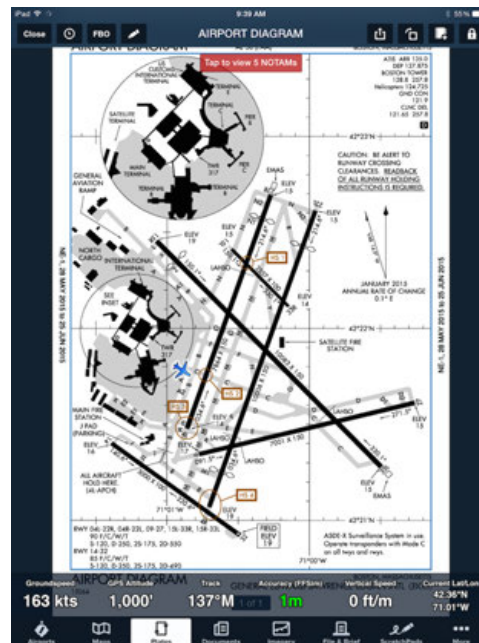

FBO Information

To access a list of Fixed Based Operators providing pilot services at an airport, tap the **FBOs** button. FBO details displayed include hours of operation, fuel prices, location on field, fuel availability, comments, contact numbers and frequencies, and any additional services provided. ForeFlight includes FBO details for thousands of airports worldwide.

The [location of FBOs](#) that sell fuel can also be shown directly on the Airport Diagram.

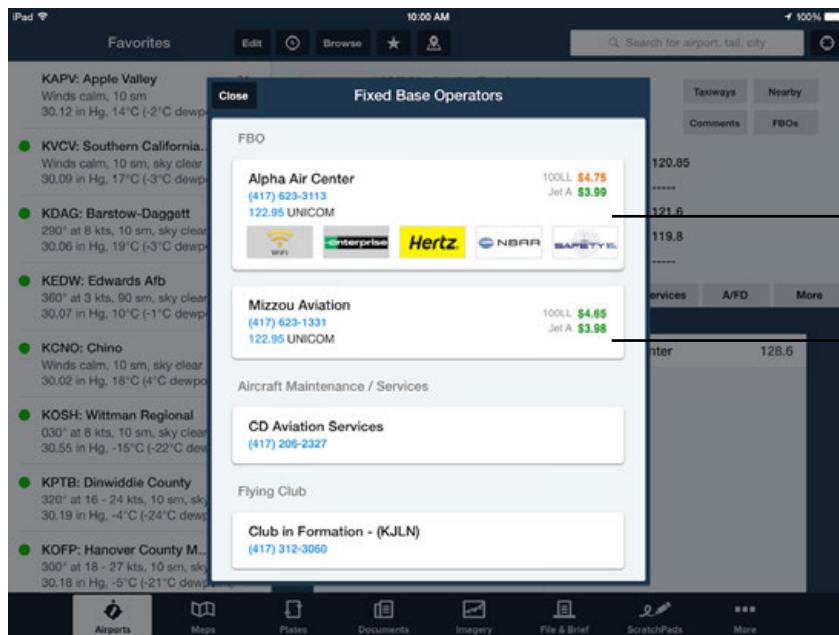

Tap FBO or Service boxes for more detailed information or to update fuel prices

Fuel prices

Fuel price data is provided for thousands of FBOs. This price data is not guaranteed, so it is important to verify the price information with the FBO when complete accuracy is required. The price data does not differentiate between cash or credit pricing, nor will it reflect any discounts that may be available.

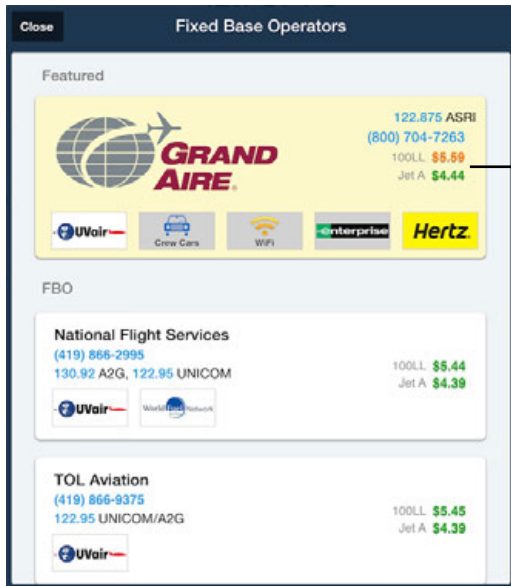

Tap for Details

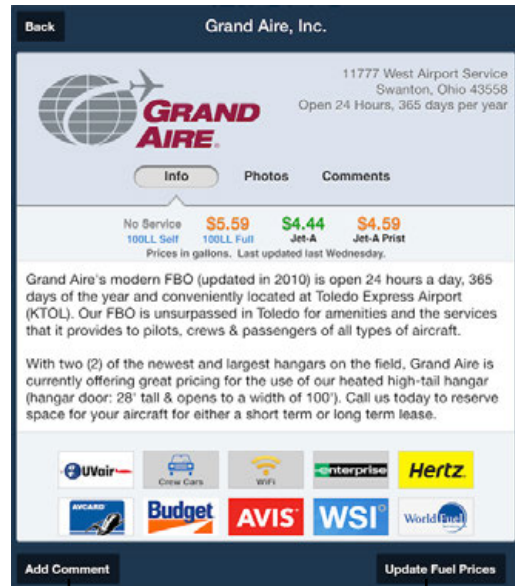

Tap to Add Comment

Tap to Update Fuel Prices

Fuel price data updates can be submitted within the application. Tap the “Update Fuel Prices” button when viewing an FBO’s details. When submitting price data, leave unknown prices blank. Blank values will be ignored when the prices are updated on the ForeFlight system.

Comments

User-provided comments are available for FBOs and airports. View FBO comments by tapping the Comments button just under the fuel price information. Once you access comments, they are saved to your device so you’ll be able to view them again later - even when you are offline.

To add a comment, tap the “Add Comment” button. Comments are moderated by ForeFlight and will appear for all users to see after they are reviewed.

Airport/Facility Directory (A/FD) or Canada Flight Supplement (CFS)

For additional airport information like pilot-controlled lighting procedures, parachute jumping activities, etc., sometimes there's just no better place than a good old-fashioned Airport/Facility Directory (or the Canada Flight Supplement).

NEW YORK 205

JOHN F KENNEDY INTL (JFK)(KJFK) 13 SE UTC-5(-4DT) N40°38.39' W73°46.74' NEW YORK
 14 B S4 FUEL 100LL, JET A OX 1, 3 LRA Class I, ARFF Index E NOTAM FILE JFK COPTER
 RWY 13R-31L: H14511X200 (CONC-GRVD) D-210, 2S-175, 2D-550, 2D/2D2-1100 PCN 9R/B/W/T HIRL CL H-10I, 12I, L-33B, 34H IAP, AD
 RWY 13R: RLLS. PAPI(P4L)—GA 3.0° TCH 73'. Thld dsplcd 2043'. Rgt tfc.
 RWY 31L: PAPI(P4L)—GA 3.0° TCH 67'. Thld dsplcd 3263'.
 RWY 04L-22R: H11351X150 (ASPH-CONC-GRVD) D-210, 2S-175, 2D-550, 2D/2D2-1100 PCN 90 F/B/W/T HIRL CL
 RWY 04L: PAPI(P4L)—GA 3.0° TCH 72'.
 RWY 22R: Thld dsplcd 2696'. Fence.
 RWY 13L-31R: H10000X150 (ASPH-GRVD) D-210, 2S-175, 2D-550, 2D/2D2-1100 PCN 90 F/B/W/T HIRL CL
 RWY 13L: ALSF2. TDZL. VASI(V12)—GA 2.75° TCH 65'. Thld dsplcd 905'. Road. Rgt tfc.
 RWY 31R: MALS. TDZL. Thld dsplcd 1030'.
 RWY 04R-22L: H8400X200 (ASPH-GRVD) D-210, 2S-175, 2D-550, 2D/2D2-1100 PCN 90 F/B/W/T HIRL CL
 RWY 04R: ALSF2. TDZL.
 RWY 22L: ALSF2. TDZL. PAPI(P4L)—GA 3.0° TCH 66'.
RUNWAY DECLARED DISTANCE INFORMATION
 RWY 04L:TORA-11351 TODA-11351 ASDA-11351 LDA-11351
 RWY 04R:TORA-8400 TODA-8400 ASDA-8400 LDA-8400
 RWY 13L:TORA-10000 TODA-10000 ASDA-10000 LDA-9095
 RWY 13R:TORA-14511 TODA-14511 ASDA-14511 LDA-12468
 RWY 22L:TORA-8400 TODA-8400 ASDA-8400 LDA-8400
 RWY 22R:TORA-11351 TODA-11351 ASDA-11351 LDA-8655
 RWY 31L:TORA-14511 TODA-14511 ASDA-14511 LDA-11248
 RWY 31R:TORA-10000 TODA-10000 ASDA-10000 LDA-8970
ARRESTING GEAR/SYSTEM
 RWY 04R: EMAS
 RWY 22L: EMAS
AIRPORT REMARKS: Special Air Traffic Rules—Part 97.1.1.1. Daily Arpt. Prior reservation rqrd. See Aeronautical Information Manual. Attended continuously. General Aviation, non based commercial acft ops must make arrangements for fuel prior

1 of 2

Airports Maps Plates Documents Imagery File & Brief ScratchPad More

Each airport's A/FD entry is available from the A/FD tab (or CFS tab for Canadian airports) - just as you'd see it in the familiar green-covered printed version. If the entry has multiple pages you can single-finger swipe to the left or right to change pages. A single-tap on the A/FD page will display the "1 of n" at the bottom of the page, where n is the number of pages relating to that airport.

Airport and Aircraft Flight Tracking

Flight tracking data is provided by FlightAware.com, and is available only while connected to the Internet. On the Airports page, tap on the **More** tab then choose **Flight Tracking**. Tap Scheduled Arrivals, Scheduled Departures or Enroute to open Safari and show a list of aircraft scheduled to arrive or depart, or that are enroute to the airport.

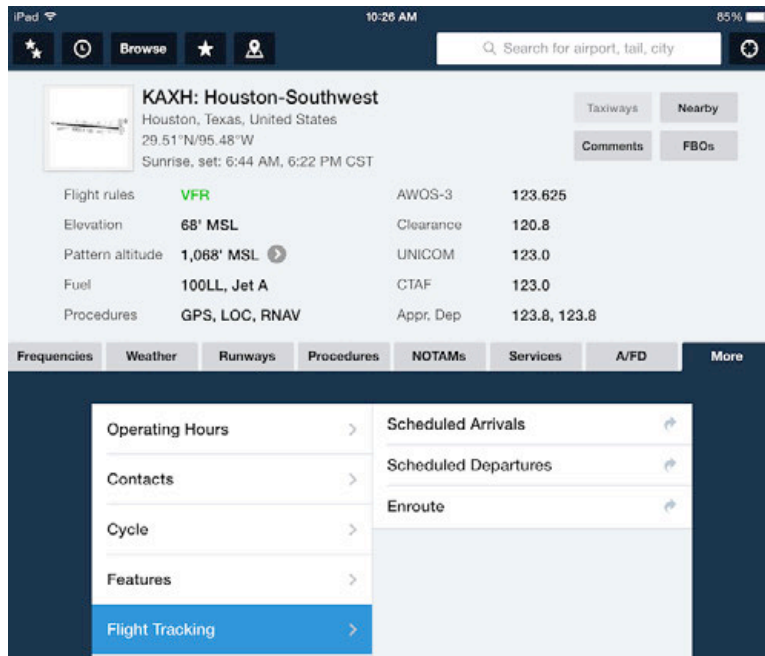

To track an individual aircraft, type an aircraft Tail-number in the Search box, then tap the "Track" button in the aircraft registration information pop-up.

Maps

About the Design

The Maps view is the place to visualize airspace, weather, terrain and other factors that may affect your route. The maps view is also the place to chart your progress during a flight. The maps themselves take center stage with supporting data surrounding them.

Hide/Show Flight Plan (! indicates Pack needed before flight)

Hide/Show Instrument Panel

Search box

Map layer

Map Settings

Synthetic Vision

Favorites

Recents

Auto-center

FROM	TO	HDG	TOTALS	LEG	REMAINING	ETA
PRUDE	JENEY	246°M	68nm 11.5g 0h43m	8nm 1.1g 4m13s	3.3nm 1m25s	19:09
JENEY	MOAKS	246°M	74nm 12.3g 0h46m	6nm 0.8g 3m10s	9.3nm 4m01s	19:11
MOAKS	BRNIE	246°M	75nm 12.6g 0h47m	2nm 0.2g 0m56s	11nm 4m47s	19:12
BRNIE	WUSPU	246°M	78nm 12.9g 0h48m	3nm 0.3g 1m20s	14nm 5m53s	19:13

Dist 279nm ETE 2h38m ETA(CDT) 21:58 Fuel 39.2g Wind 21kts head

Distance to Next: 3.3nm ETE Dest: 1h33m Groundspeed: 138kts GPS Altitude: 8,650' Track: 240°M Bearing Next: 238°M From OA12: 3.5nm NE Accuracy (FFSim): 1m

Route line (future legs) Edit, NavLog, Profile Route line (active leg) Airway label Route line (past legs)

Pinch, Zoom, and Pan

Each map in the Maps view supports the standard iPad gestures for zooming and panning. Drag your finger on the map to slide it to a new region. Use two fingers in a pinch or expand gesture to change the zoom scale of the map. You can also double tap the map to zoom in one level or tap once with two fingers at the same time to zoom out one level. Anytime you display a new route on the map the zoom level and region shown will auto-adjust to bring your route into view.

Tap the Zoom to Route button in the lower left of the Maps screen to automatically zoom the map in or out to show the entire Route.



Changing Maps / Map Layers

A variety of map types are available. To change which map is displayed, tap the Map mode button at the top left of the view. Tap a map name to select it and update the map.

The current zoom and location will not change when you change maps.

The route line for any route you've entered is always displayed on top of any map types and layers.

Each map is geo-referenced and seamless. This means that you can view your current location on the map and do not need to change maps to view a new region - simply drag with your finger.

Radar or Satellite data can be overlaid on any base map selection (such as VFR charts). Additionally, any marker or shape layer can be selected for viewing. Examples of these are TFRs or Visibility. Only one marker-type can be selected at once. To de-select a layer and hide it, tap it in the menu.

Map Types:

❖ **ForeFlight Map** - The permanent, customizable base map that all other maps and layers are overlaid on, which shows political boundaries and geographic features. See [Maps Settings](#) for more information.



- ❖ **Aeronautical** - ForeFlight's Global Aeronautical Maps. These display dynamic and customizable aeronautical data , such as airports, airspace, ARTCCs, VORs, waypoints, and more. See [Global Aeronautical Maps](#) for more information.
- ❖ **Jeppesen Enroute Charts** - Global set of VFR, IFR Low, and IFR High enroute charts. Available for anyone who purchases or links a Jeppesen chart coverage in ForeFlight. See [Using Jeppesen Enroute Charts in ForeFlight](#) for more information.
- ❖ **Street Map** - Detailed street map. This map can only be used when connected to the Internet. However, views you display while connected to the Internet are cached in memory and may be available in-flight, provided the cache is not cleared or filled to capacity.
- ❖ **Aerial Map** - Satellite image map including street labels. This map can only be used when connected to the Internet. However, views you display while connected to the Internet are cached in memory and may be available in-flight, provided the cache is not cleared or filled to capacity.
- ❖ **U.S. VFR Sectional** - Terminal Area Charts (TACs) are automatically displayed when a VFR sectional is zoomed in to major cities containing a TAC inset.
- ❖ **U.S. IFR Enroute** - low or high.
- ❖ **Canada VNC** - VFR Terminal Area Charts (VTAs) are automatically displayed when a VNC is zoomed in to major cities containing a VTA inset. Requires ForeFlight Canada subscription.
- ❖ **Canada IFR Enroute** - low or high. Requires ForeFlight Canada subscription.
- ❖ **U.S. IFR (planning)** - IFR planning chart covering contiguous 48 states.
- ❖ **World Aeronautical** - VFR chart covering the contiguous 48 states + Alaska. WAC charts covering northern Mexico (extending south to the tip of Baja) and the northern Caribbean (extending south to Guadeloupe island) can also be downloaded. Tap **More > Downloads > Caribbean, Mexico, Central America**, then turn **World Aeronautical Charts** to **ON**.
- ❖ **U.S. IFR (ocean)** - Atlantic and Pacific ocean IFR charts.
- ❖ **Carib/Mexico IFR** - IFR Low or High charts covering Mexico and the Caribbean. Tap **More > Downloads > Canada, Mexico, Central America**, then turn **IFR Low Charts** and/or **IFR High Charts** to **ON**.
- ❖ **U.S. Helicopter** - Three-color charts showing aeronautical information useful to helicopter pilots navigating in 9 major metro areas with heavy helicopter activity. Includes helicopter routes, heliports, navaids and obstructions. Can be selected with any U.S. base map.

❖ **Heli Gulf VFR** - U.S. VFR Sectional-style chart of the Gulf of Mexico (GOM) showing airspace, GOM blocks, airspace, and oil rig and weather station locations. Can be selected with any U.S. base map.

❖ **Heli Gulf IFR** - IFR style chart of the Gulf of Mexico (GOM) showing GOM blocks, GPS waypoints, airspace and weather station locations. Can be selected with any U.S. base map.

❖ **User Charts** - display a custom .mbtiles chart on the map. Multiple user charts can be imported, but only one can be displayed at a time. See the [User Content](#) section for details about creating the files and importing them into the app.

Map Layers:

Refer to the [Weather Legends](#) chapter near the bottom of this document or the dedicated **Legends in ForeFlight Mobile** guide to find legends for many of the following map layers.

Map layers IMPORTANT NOTICE:

An active Internet connection or in-flight weather receiver such as a Stratus 2 ADS-B or SiriusXM SXAR1 are required to display timely map layer information.

Immediately before your flight: While still connected to the Internet, use the [Pack](#) feature to ensure all relevant TFR and weather data is downloaded. Note the time-stamp in the upper-left corner of the Maps page, indicating the time when the layer's data was received.

❖ **Radar (Composite)** - Radar for the US and Canada showing a composite of multiple angles of radar scan.

❖ **Radar (Lowest Tilt)** - Radar for the US and Canada showing only the lowest angle (tilt) radar scan, useful for determining where precipitation is actually reaching the ground.

You can animate the radar layers using the [Time Slider](#). The radar layers check for updates every three minutes. For more details, see the [Radar Legend](#), and radar color vs. intensity legends for [Rain](#), [Mixed Rain/Snow](#), and [Snow](#).

Radar requires an active Internet connection, or ADS-B "In" receiver (Composite only), or SiriusXM in-flight weather receiver (Composite and Lowest Tilt). Selecting Radar in-flight without one of these will display diagonal hashmarks with the message "Radar not Available" across the Map. Clear the hashmarks and message by de-selecting the Radar layer using the Maps drop-down.

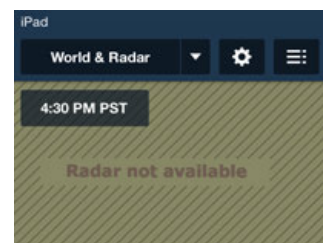

❖ **Echo Tops (requires SXAR1)** - Displays the height where ground-based radar detects reflectivities above 18 dBZ. Use the altitude slider on the right to filter out echo tops at lower altitudes. Covers CONUS plus northern Mexico and southern Canada.

❖ **Cloud Tops (requires SXAR1)** - Displays cloud top height derived from satellite temperature sensors. Use the altitude slider on the right to filter out cloud tops at lower altitudes. Covers CONUS plus northern Mexico and southern Canada.

❖ **Enhanced Satellite** - Visible- or infrared-derived (depending on time of day) grayscale satellite with color infrared highlights for high-altitude cloud tops.

❖ **Color IR Satellite** - Infrared satellite colorized to depict the temperature of the cloud tops. Ground temperature depictions are masked out to show regions without clouds. Color-temperature scale is the same as used in the [Infrared Satellite imagery](#).

You can animate the satellite layers using the [Time Slider](#). The satellite layers check for updates every three minutes, but new images are typically transmitted every 30 minutes.

Satellite requires an active Internet connection or Baron Mobile Link weather receiver (IR Satellite is not available with Baron Mobile Link). The Satellite layer is not available with an ADS-B or SiriusXM weather receiver.

❖ **Icing (SXM) (requires SXAR1)** - Displays icing severity levels (light, moderate, heavy), plus SLD threat. Use the altitude slider on the right to view icing severity at different altitudes. Covers CONUS plus northern Mexico and southern Canada generally between 16N and 59N Latitude.

❖ **Icing (US)** - Displays icing severity forecasts (light, moderate, heavy). Use the [Time Slider](#) to view different frames in the forecast, and use the altitude slider to view icing severity at different altitude. Covers CONUS plus northern Mexico and southern Canada generally between 16N and 59N Latitude. Requires a Pro Plus, Performance Plus, or Business Performance subscription.

❖ **Icing (Global)** - Displays icing severity forecasts (light, moderate, heavy). Use the [Time Slider](#) to view different frames in the forecast, and use the altitude slider to view icing severity at different altitude. Provides worldwide coverage. Requires a Pro Plus, Performance Plus, or Business Performance subscription.

❖ **Turbulence (SXM) (requires SXAR1)** - Displays turbulence intensity forecast based on a **medium** aircraft weight category. Use the altitude slider on the right

to view turbulence intensity forecasts at different altitudes. Covers CONUS plus northern Mexico and southern Canada.

❖ **Turbulence (US)** - Displays EDR (eddy dissipation rate) forecasts which translate into turbulence severity based on aircraft weight. Use the [Time Slider](#) to view different frames in the forecast, and use the altitude slider on the right to view EDR forecasts at different altitudes. Covers CONUS plus northern Mexico and southern Canada generally between 16N and 59N Latitude. Requires a Pro Plus, Performance Plus, or Business Performance subscription.

❖ **Turbulence (Global)** - Displays EDR (eddy dissipation rate) forecasts which translate into turbulence severity based on aircraft weight. Use the [Time Slider](#) to view different frames in the forecast, and use the altitude slider on the right to view EDR forecasts at different altitudes. Provides worldwide coverage. Requires a Pro Plus, Performance Plus, or Business Performance subscription.

❖ **Sfc Analysis (SXM) (requires SXAR1)** - Displays isobars, pressure readings, and other weather features associated with a surface analysis product. Covers almost all of North and Central America (excluding northernmost Canada and Alaska) and as far west as Hawaii.

❖ **Surface Analysis** - Displays isobars, pressure readings, and other weather features associated with a surface analysis product. Use the [Time Slider](#) to view different frames in the forecast. Provides global isobar and pressure readings and more detailed weather features for North America. Requires a Pro Plus, Performance Plus, or Business Performance subscription.

❖ **Hazard Advisor** - Terrain-based map, colored red or yellow based on terrain height relative to aircraft position (yellow for terrain between 1,000' and 100' below the aircraft, red for higher terrain). Also shows obstacles in local area within 1,000' of aircraft altitude. *Available on iPad 2 and iPhone 4 (or newer) with a ForeFlight Pro, Pro Plus, or Performance Plus subscription.*

❖ **Search & Rescue Grids:** *These map layers are available when Search and Rescue is enabled in Settings. For more details see the Search and Rescue Supplement in Documents > Catalog > ForeFlight:*

❖ **CAP Grid** - "Conventional" 15-minute quadrangle grid squares, in the format ORD385.

❖ **Cell CAP Grid** - "new" grid based on 1 degree of latitude/longitude, in the format 40092AA.

❖ **GARS Grid** - Grid Area Reference System made up of 30-minute cells with 15-minute quadrants and 5-minute areas, in the format 175LX.

❖ **Traffic (requires ADS-B)** - When connected to an ADS-B receiver, the Traffic option is shown. When selected, ADS-B traffic is displayed on the map. **TRAFFIC DISPLAY WILL BE LIMITED UNLESS YOUR AIRCRAFT IS EQUIPPED WITH ADS-B OUT. SEE [ADS-B TRAFFIC SECTION](#) FOR MORE DETAILS.**

❖ **TFRs** - covers regions provided by FAA as well as 3rd party sources (Stadium TFRs). Tap a TFR shape to see more details. TFR shapes are shown in **yellow** until 8 hours before the scheduled start time. Within 8 hours of the TFR being active, it is shown in **red** until the end of the TFR.

TFRs IMPORTANT NOTICE:

Graphical TFR information is **ONLY** updated and displayed if you select the TFR Map layer while connected to the Internet, or while using an in-flight weather receiver.

However if the FAA publishes a TFR without associated graphical shape information it may not be possible for ForeFlight Mobile to show the graphical TFR on the Maps page.

Therefore you should also check the Airports page, under NOTAMs > TFRs for airports along your route, and contact FSS or ATC to confirm that your route does not cross any such TFRs

Immediately before your flight: While still connected to the Internet, use the [Pack](#) feature to ensure all relevant TFR and weather data is downloaded. TFRs issued **after** you Pack will not be shown, unless you are using an ADS-B or XM in-flight weather receiver.

For limitations when using a Stratus ADS-B receiver or Baron Mobile Link XM weather receiver, please see the [Stratus ADS-B Weather](#) or [XM Weather chapters](#).

❖ **AIR/SIGMET/CWAs** - covers regions provided by FAA, as well as international SIGMETs. The shapes are colored-coded based on type:

Blue for freezing level and icing conditions.

Orange for turbulence and high winds.

Purple for IFR.

Pink for mountain obscuration.

Yellow for convective outlooks.

Red for SIGMETs of all types.

Light Blue for Center Weather Advisories.

These types can be selectively filtered from the map using the four buttons that appear at the bottom of the screen when the layer is selected.

Tap an AIR/SIGMET/CWA shape to display a pop-up listing all advisories at that location, then tap on one to see full details about the advisory, including the highlighted lateral boundary (thick red border in the image at right); this is especially useful when multiple *METs overlap in one place.

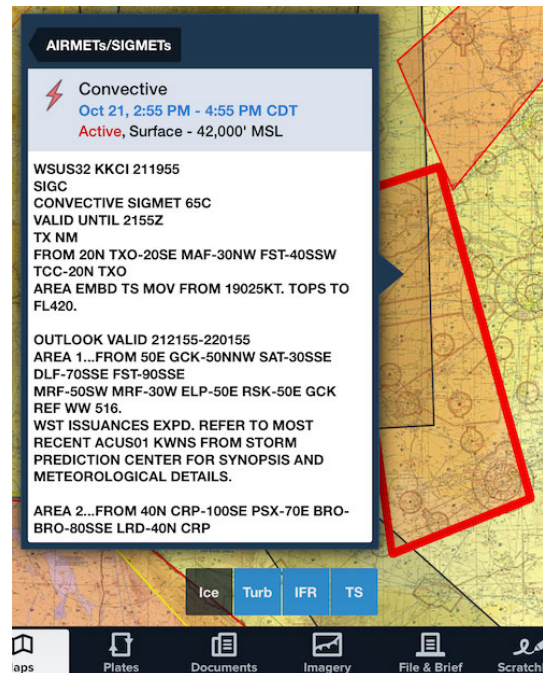

❖ **Weather Layers** - a variety of weather measurements can be displayed on the map: Flight Category, Winds Aloft, Dewpoint Spread, Temperature, Visibility, Surface Wind, Ceiling, Sky Coverage, PIREPs, and Lightning. The weather layers are updated every five minutes when connected to the Internet. See [Weather Layer Color Coding](#) for details of color coding for each type of layer.

❖ **Winds Aloft** - Forecasted Winds Aloft, up to 6 hours ahead. To adjust the altitude of the displayed forecasted winds, tap-hold on the altitude slider and move it up or down until your desired altitude is shown, or tap on the bar above or below the slider to move the slider by one increment in either direction. You can select altitudes from 3000' to FL540 in 3000' increments.

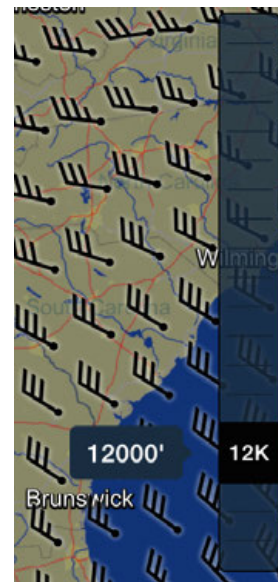
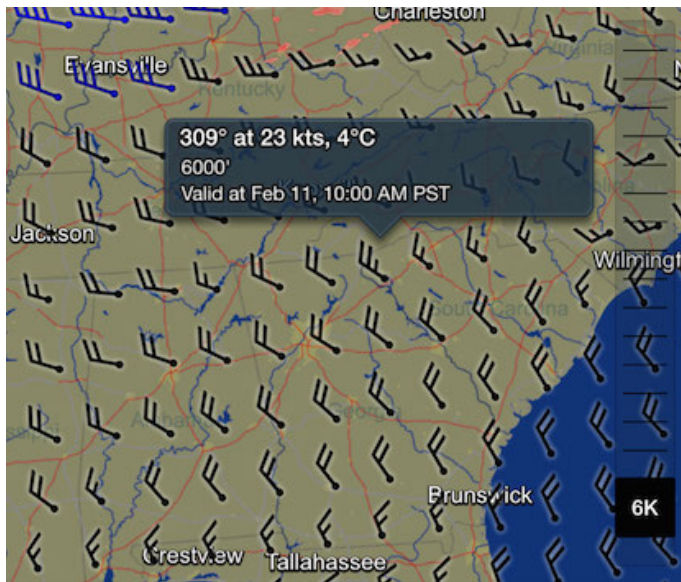

Tap a winds barb to see the forecasted wind speed, direction and temperature at that altitude, and the “Valid at” time for that forecast.

❖ **Surface Winds** - derived from METARs at Airports, shows wind speed and direction at those locations only. *See below for side-by-side comparison.*

❖ **Surface Wind Analysis (requires SXAR1)** - generated from an automated forecast model, shows forecast wind speed and direction at tens of thousands of evenly spaced points across the country. Good for viewing low-level circulations across a wide area.

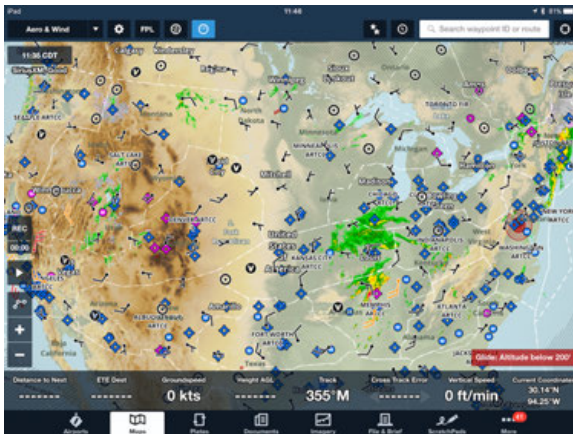

Surface Winds

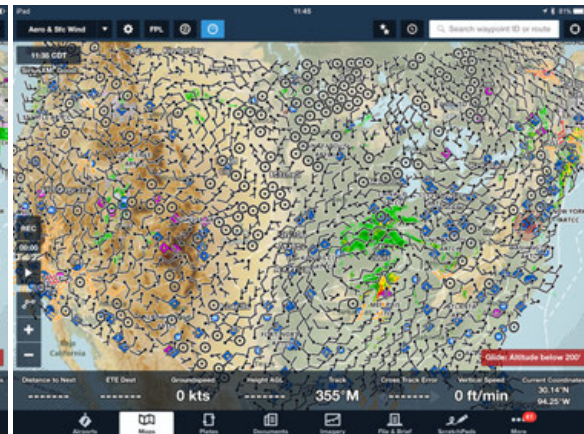

Sfc Wind Analysis

❖ **Obstacles** - shows obstacle markers based on the FAA’s USA data.

❖ **User Waypoints** - all User Waypoints view are shown on the Map.

❖ **Fuel prices** - prices for 100LL or JetA fuel. Fuel prices are color coded by price in the region where the airport is located - less expensive prices are in green,

average in orange, most expensive in red. When searching for the best prices, **Zoom-in** to display more vendors' prices in a given area.

❖ **KML User Map Shapes** - display a custom KML shapefile on the Map. Multiple KML files can be imported, but only one can be displayed at a time. See the [KML User Map Shapes](#) section for details about creating the files and importing them into the app.

NOTE: The Radar layer requires an Internet, ADS-B, or XM WX (SiriuXM SXAR1 or Baron Mobile Link) connection. The Satellite layer requires an Internet or XM WX (Baron Mobile Link only) connection. Weather layers require an Internet connection. Fuel price layers require an Internet connection the first time they are used. The **Downloads** view can be used to download Obstacles as well as World, IFR, and VFR charts for use when offline.

Weather Layer Time Slider

When you select a time- or forecast-based weather layer like radar, satellite, or the icing/turbulence/surface analysis layers, a time slider tool appears at the bottom of the screen. Tap the play button on the left to animate the layer; this advances the time slider frame-by-frame, while the timestamp on the left shows the date and time when each frame was valid. Forecast-based weather layers use a vertical white bar on the time slider to indicate the present time.

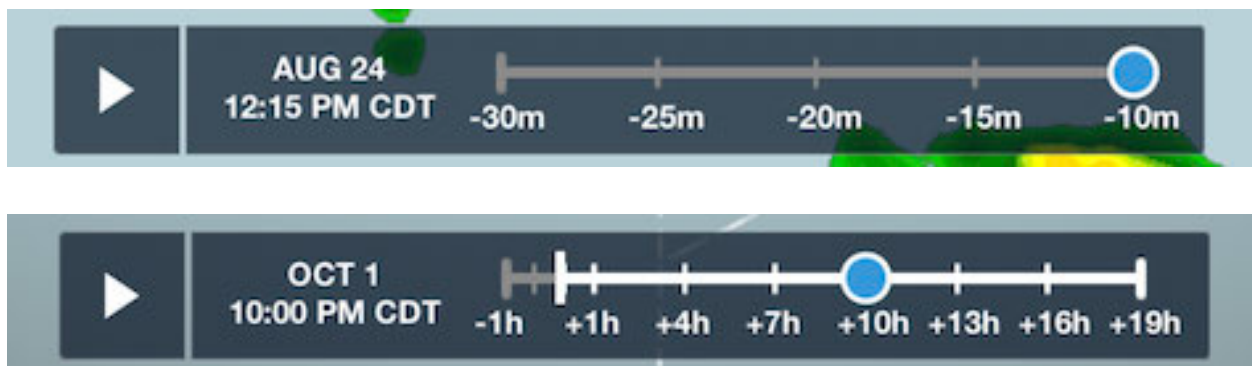

You can manually control the animation by tap-holding on the time slider and dragging it left or right to view different frames, or by tapping on the line to the left or right of the slider to advance it one frame at a time in either direction.

Global Aeronautical Maps

ForeFlight Global Aeronautical Maps utilize a new kind of mapping technology which uses sets of digital aeronautical data to display information on the map. This differs from traditional VFR and IFR charts which are digital image files of charts, also known as “raster” charts. Building a map or chart layer using pure digital data allows information to be manipulated and displayed in many useful and powerful ways.

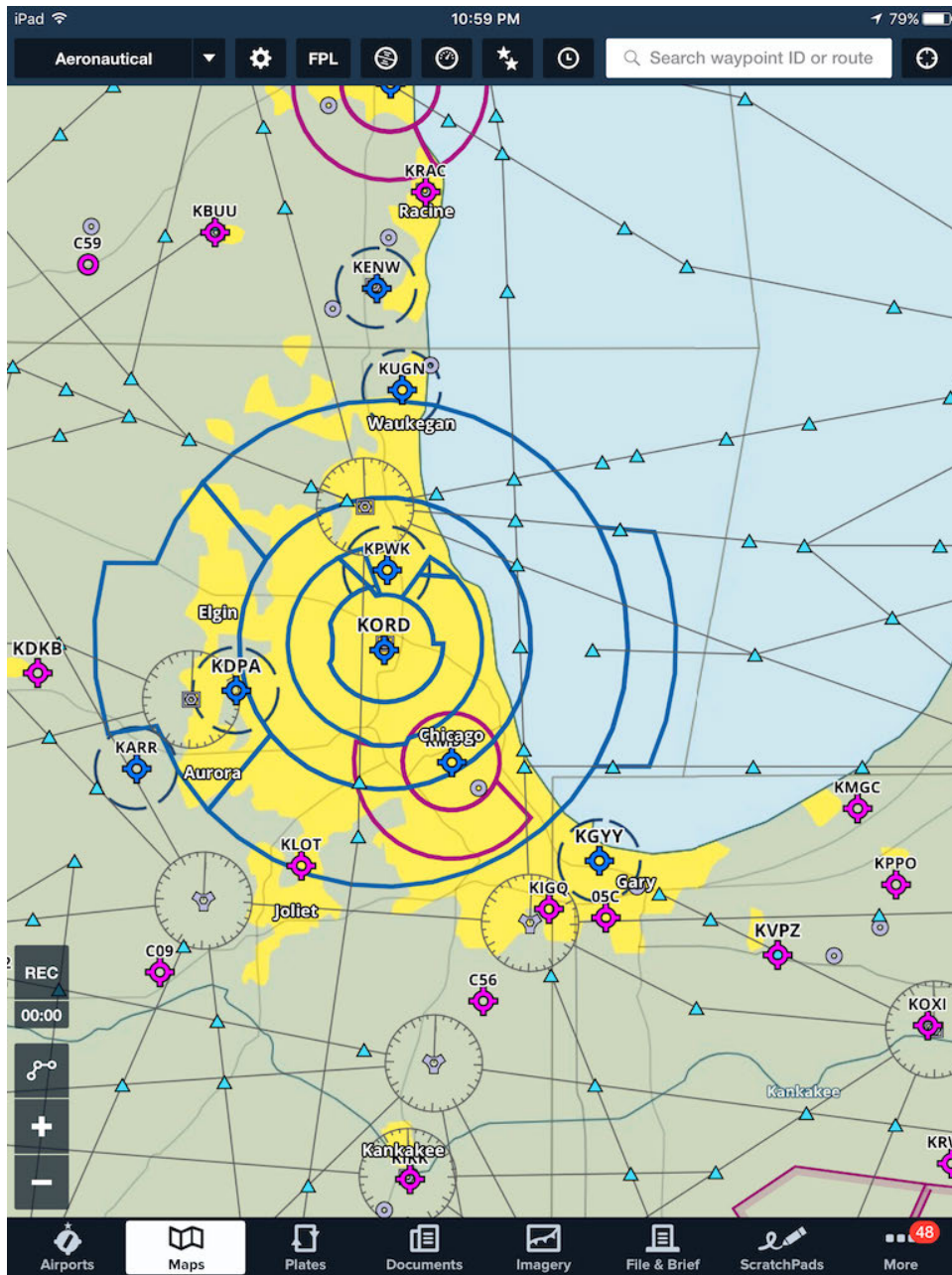

The data used in the Aeronautical Maps come from the FAA, Nav Canada, Eurocontrol, and other official sources. Updates are delivered as part of the Airport and Nav Database updates, which are delivered every 28 days, or more often as needed.

Global Aeronautical Maps are available with the Basic Plus, Pro Plus, and Business Pro subscription plans, and are also available as an add-on for other plans.

The Aeronautical data can be displayed over either a “Light” or “Dark” color scheme, or pilots who like the traditional “World Map” from previous versions of the app can choose “Classic.”

When viewing the Aeronautical data by itself, Terrain data can also be included on the map via a switch in [Maps Settings](#).

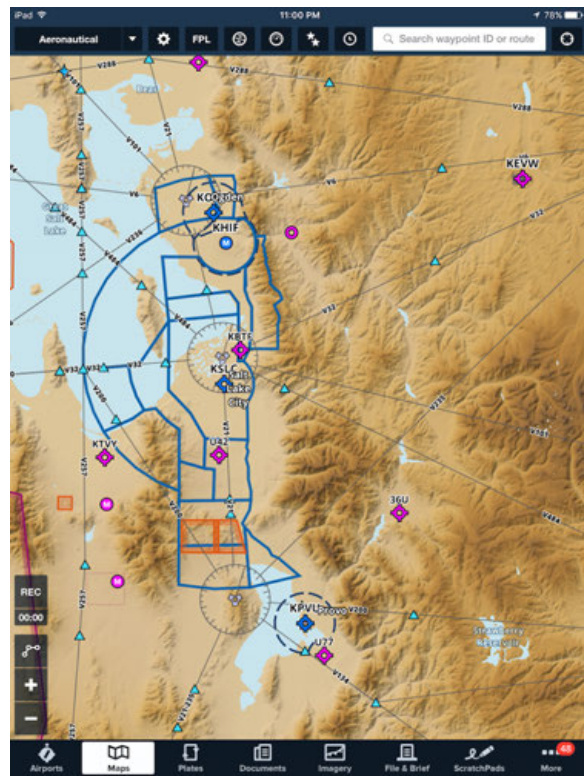
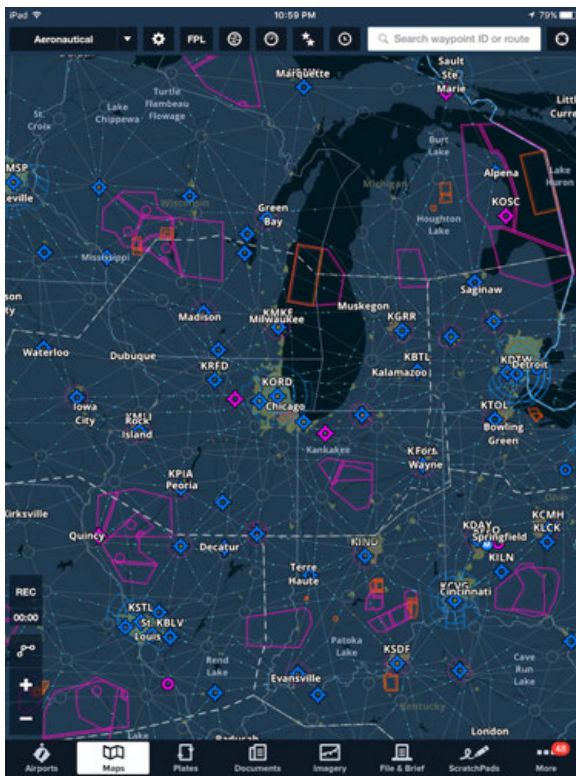

The Aeronautical data can also be overlaid over any available chart or map type.

Aeronautical Maps Features

- ❖ **Continuous Zoom** - Icons, shapes, and text labels smoothly fade in and out as the zoom level changes, in contrast to raster charts which have to re-render at certain zoom levels to maintain their clarity.

❖ **Decluttering** - The information shown on the map changes along with the zoom level, with large-scale features like ARTCC boundaries and major airports appearing when zoomed out, and small-scale features like waypoints, VORs, and smaller airports appearing as you zoom in. This prevents the map from becoming too cluttered with information, and ensures that the most relevant information at any zoom level is shown.

❖ **Always-Up Labels** - Labels for airports, waypoints, and other map features always appear in the proper orientation, even when the rest of the map is upside down, as when flying south in “Track Up” mode.

❖ **Customizable Data** - The data shown on the map can be customized to the type of planning or flying you’re doing. Airspaces can be turned on or off, airways can be set to either high or low IFR, and ARTCC borders, heliports, and private airports can be toggled on or off. See [Maps Settings](#) for more information.

❖ **Adjustable Text Size** - The text size of labels for every map element can be adjusted using a slider. See [Maps Settings](#) for more information.

❖ **Single Tap** - When the Aeronautical layer is enabled, tapping on the icon for any map item will open that item’s detail view, allowing you to bypass the tap-hold action and “Add to Route” popup that is normally required to see details about a map item.

❖ **Embedded Airport Diagrams** - ForeFlight airport diagrams are directly integrated with the Aeronautical Maps, fading in as you zoom into an airport. The diagrams include labels for runways, taxiways, hold pads, and FBOs.

Aeronautical Maps Symbols

The following symbols are shown on the Aeronautical Maps layer:

	Civil Airports with Services (with and without tower)		Civil Airports without Services (with and without tower)
	Military Airports (with and without tower)		Private Airports (with and without tower)
	Seaplane Bases with Services (w/ and w/o tower)		Seaplane Bases without Services (w/ and w/o tower)
	Heliports (light map color scheme)		Heliports (dark map color scheme)
	Standard fix		RNAV fix
	VOR Navaid		VOR/DME Navaid
	VORTAC Navaid		NDB Navaid
	NDB/DME Navaid		FBO Location (on ForeFlight airport diagram)
	ARTCC Boundary		ADIZ
	Class B Airspace		Class B Altitude
	Class C Airspace		Class C Altitude
	Class D Airspace		Class D Altitude
	Class E surface area		Mode C
	TRSA		SATR Area
	CTRs		MOA/Alert/Training Airspace
	Caution/Warning/Danger Airspace		Prohibited/Restricted Airspace
	Other Airspace		VOR Airways/Jetways
	RNAV Routes		Airway ID (MEA)

Maps Settings

Tap the Maps **Settings** button  next to the map selection button in the dark blue tool bar to show the following Map settings:

Screen Brightness

❖ The brightness slider integrates with the iPad's brightness slider, but allows for even more dimming (see the [Settings](#) section for more info).

❖ **Invert Chart Colors** - turn *ON* to invert black and white colors on charts for improved low-light viewing (does not affect Street or Aerial maps). This setting can also be independently enabled for Plates and Documents. **NOTE:** The Aeronautical map and Jeppesen enroute charts are not affected by Invert Chart Colors, so you may want to choose the Dark Map Theme (see below) for low-light viewing when those are selected.

ForeFlight Map

❖ **Map Theme** - select the color theme of the base map. Three options are available: Classic, Light, and Dark.

❖ **Terrain** - select the terrain style to display on the base map. Three options are available: Off, Shaded Terrain (uses grayscale shading to depict local terrain variations), and Colored Terrain (uses colored shading to depict terrain elevation). Both low- and high-resolution worldwide terrain data can be downloaded.

❖ **Place Labels** - turn *ON* to add text labels that identify political and geographic features.

❖ **Roads** - turn *ON* to add major roads, highways, and railroads to the base map.

Aeronautical (when Aeronautical layer is selected)

❖ **Airports** - customize what airports are shown on the map by enabling or disabling heliports, private airports, and seaplane bases.

❖ **Airspace** - customize what airspace is shown on the map by enabling or disabling controlled airspace, SUA/MOA, TRSA, Class E, Mode C, and ADIZ.

❖ **Airways** - change the airways, waypoints, and VOR radials shown on the map. Three options are available: Off, Low, and High.

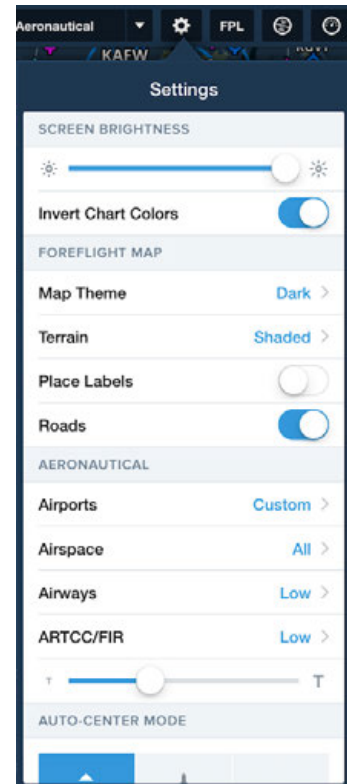

❖ **ARTCC/FIR** - change the ARTCC frequency stamps shown on the map. Three options are available Off, Low, and High.

❖ Slider for adjusting the text size of aeronautical elements on the map. The full range of the slider goes from 75% to 150% of normal text size. The slider does not affect place labels or text on other maps or charts.

Jeppesen (when a Jeppesen enroute chart is selected)

❖ See [Using Jeppesen Enroute Charts in ForeFlight](#) for information on the available settings.

Auto-Center Mode

❖ Mode selector for auto-center/moving-map operation: North Up, Track Up Centered, Track Up Forward (see [Track Up](#) for additional information).

Map Layers

❖ **Hide Distant Traffic** - turn *ON* to hide traffic beyond 15nm radius and +/- 3,500' from your location/altitude (setting is only shown when connected to an ADS-B receiver; see [ADS-B Traffic](#)).

❖ **Route Labels** - turn *ON* to enable waypoint and airway labels on route lines.

❖ **Extended Centerlines** - turn *ON* to enable extended runway centerlines at airports in the current route. Centerlines extend 5 NM from runway end.

❖ **Distance Rings** - turn *ON* to enable three concentric rings around your aircraft (See [Distance Rings](#) for additional information).

❖ **Glide Advisor** - turn *ON* to enable the green Glide Advisor ring. Glide Advisor ring is hidden at GPS altitudes below 200' AGL.

❖ **Glide Settings** - select glide data to use for Glide Advisor, enter glide performance information (speed and glide ratio, assuming ratio is to 1, eg 8.0:1), and shortcuts to edit glide information for aircraft in the More > Aircraft menu.

❖ **Track Vector** - turn *ON* to display a projected track vector ahead of your aircraft icon (see [Track Vector](#) for additional information).

❖ **Track Log Record Button** - turn *ON* to display the "REC" button on the Maps view for recording ForeFlight [Track Logs](#).

❖ **Four-color Radar** - turn *ON* to display radar in a low resolution, four-color scheme that complies with dBZ-to-color mapping standards defined by the Radio Technical Commission for Aeronautics. See [Radar Legends](#) for more information.

❖ **Map Touch Action** - select what happens when you tap on multiple overlapping charts. “No action” displays charts seamlessly stitched together in the default order. Choose “Bring chart to front” and single-tap the chart to cycle through the charts that overlap at that point. Choose “Bring chart to front with legends” to also show the chart legend and border when tapping to cycle through the charts. See additional details in the Map Touch section below.

Opacity Sliders

❖ Slider to change the opacity of radar, TFRs, and other weather layers, and another to change the opacity of plates overlaid on the map (see [Plate on Maps](#) for additional information).

Devices

❖ Quick access to external device status info (see [ForeFlight Connect](#) for information on compatible devices).

Map Touch

Map Touch is an enhancement to the traditional seamlessly-stitched charts that allows each individual chart to also be displayed either as a “trimmed” version without legends or margins, or as a “collared” version that shows the unaltered chart with all legends and borders.

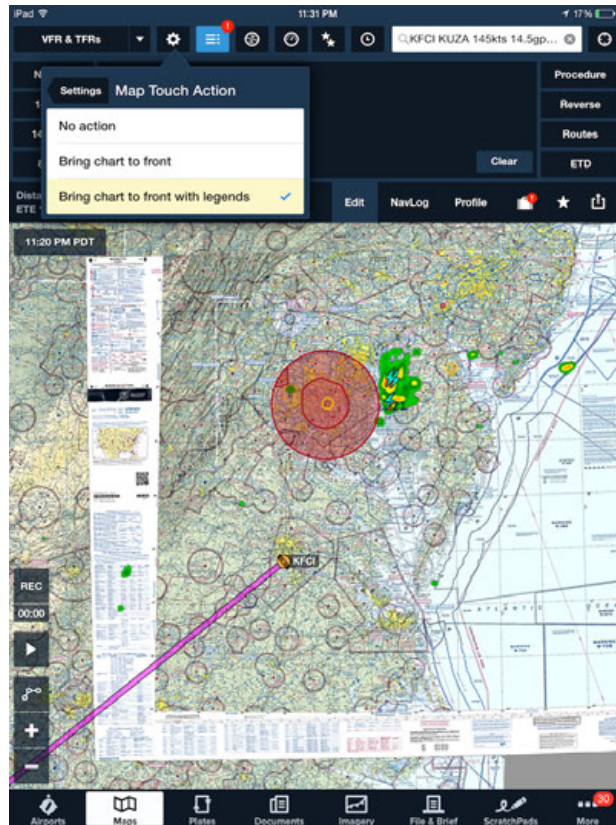

The Map Touch Action is selected using the Maps Settings menu, or in More > Settings.

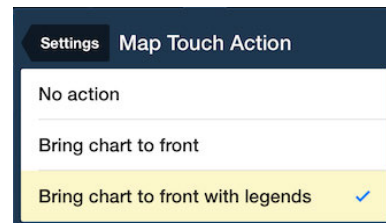

When **Bring chart to front** or **Bring chart to front with legends** is selected in Maps Settings, a single tap on a point where multiple charts overlap will cycle through the charts that overlap at that point. This is useful if there is information on one chart that is obscured by the seamless chart “cut” line. Additional single taps will bring each chart forward in turn.

Bring chart to front



IMPORTANT: Because not every chart is published at the same time, airspace or restricted areas may not be depicted the same on overlapping charts. Consult all applicable charts when planning a flight.

Smart Airway Labels

When the route entered in the Route Editor includes one or more airways, dynamic labels appear along each airway segment with information about the segment, including the name of the airway, the segment's MEA, and the segment's MOCA, if it has one. These labels expand to fill available space between waypoints, adding more information as you zoom in.

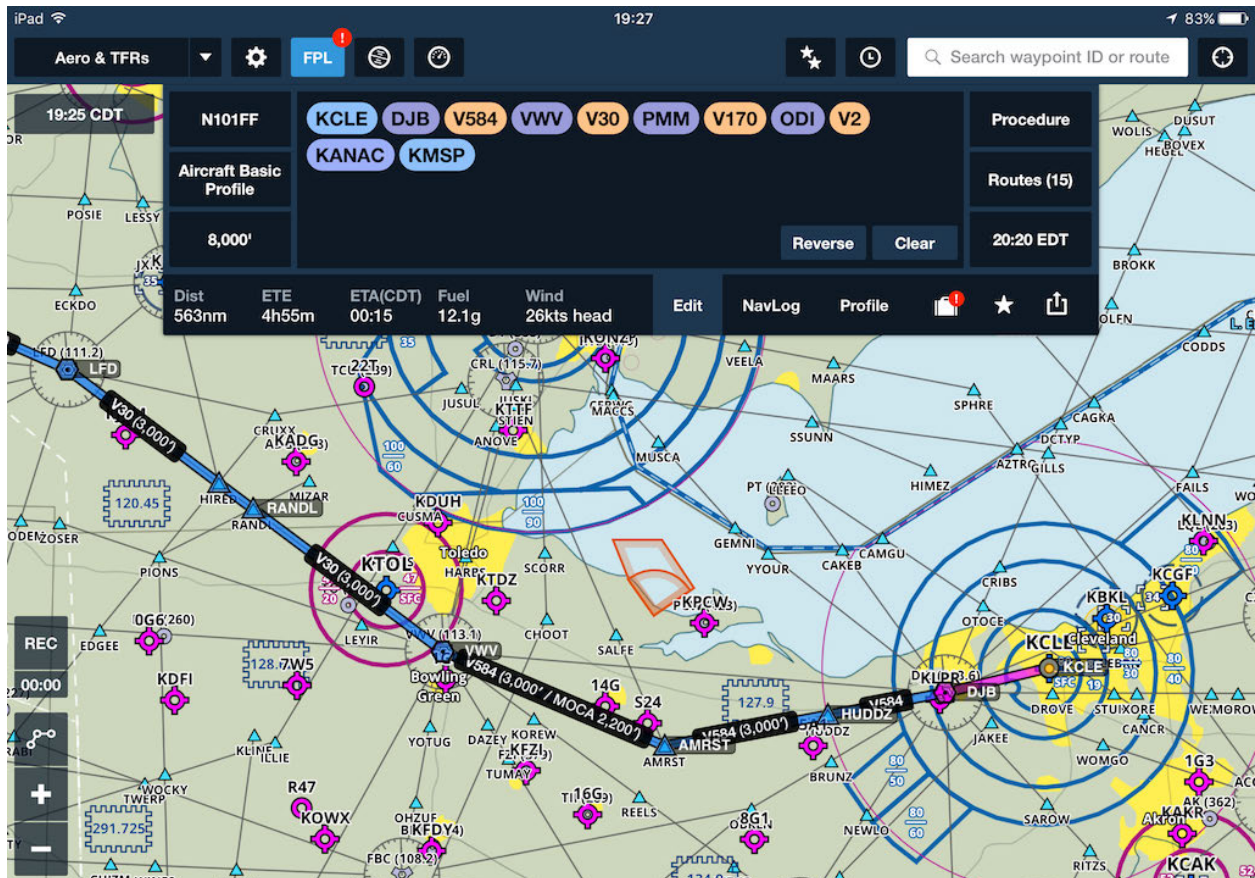

Smart airway labels only appear when an airway is explicitly named in the Route Editor, meaning that one of the route "bubbles" is the airway's name. Building a route with the individual waypoints in an airway but without naming the airway itself will result in the airway labels not appearing.

Smart airway labels are tied to other route labels, and can be disabled by turning off Route Labels in [Maps Settings](#).

Airport popup

The Airports popup allows you to quickly check the same information contained in the Airports view right on the Maps view.



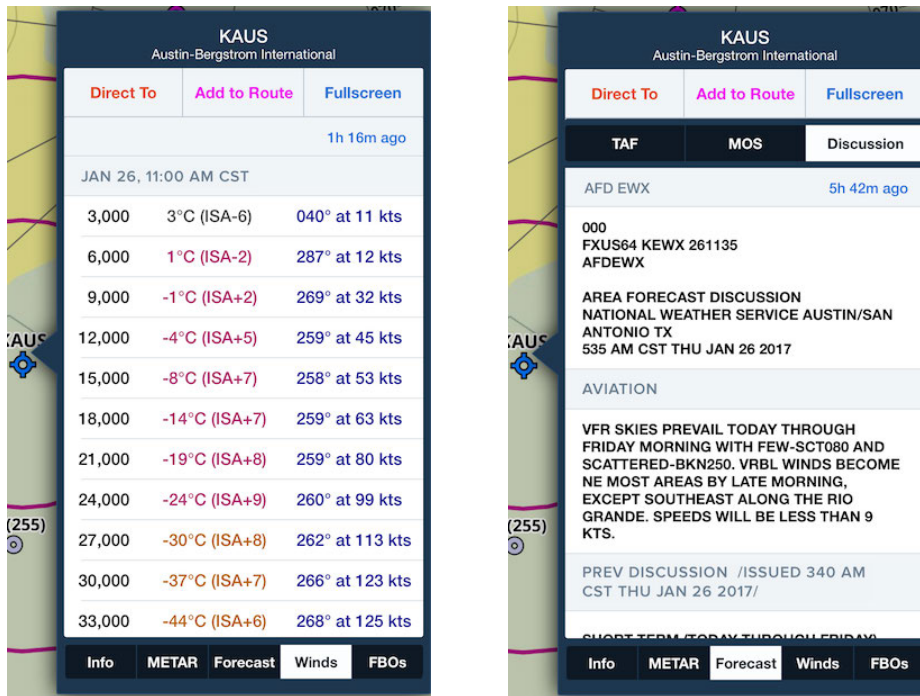



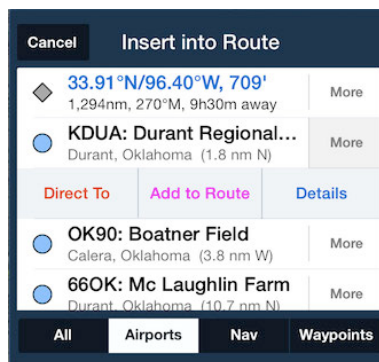









When displaying the Aeronautical Map or a weather layer on the Maps view, tap on an airport's icon to display the Airport popup. The **Info** filter shows airport information like runways, frequencies, approaches, etc... The **METAR**, **Forecast**, and **Winds** filters show weather information, and the **FBO** filter shows FBO information and fuel prices.



















If a tappable layer is not selected, tap-hold on the map near the airport's location. Tap **More**, and then **Details** to display the Airport popup.



Weather Layer Color Coding

Weather Layer	Color coding	
Flight Category	<p> LIFR: Magenta. Ceiling less than 500' and/or visibility less than 1 mile.</p> <p> IFR: Red. Ceiling 500' to less than 1,000' and/or visibility 1 to less than 3 miles.</p> <p> MVFR: Blue. Ceiling 1,000' to 3,000' and/or visibility 3 to 5 miles inclusive.</p> <p> VFR: Green. Ceiling greater than 3,000' and visibility greater than 5 miles; includes sky clear.</p> <p> Unknown: grey question-mark</p>	
Winds Aloft <i>(wind barb color)</i>	<p>Altitudes < 12,000'</p> <p> 0-29 knots</p> <p> 30-39 knots</p> <p> 40-49 knots</p> <p> 50-59 knots</p> <p> 60-69 knots</p> <p> ≥70 knots</p>	<p>Altitudes ≥ 12,000'</p> <p> 0-69 knots</p> <p> 70-89 knots</p> <p> 90-109 knots</p> <p> 110-124 knots</p> <p> 125-149 knots</p> <p> ≥150 knots</p>
Surface Wind <i>(wind barb color)</i>	<p>Black: Peak <20 knots</p> <p>Orange: Peak 20-30 knots:</p> <p>Red: Peak >30 knots:</p>	

<p>Wind Barb symbology</p>	<p>Wind direction is in "true" degrees depicted by a stem (line) pointed in the direction the winds are coming from. Barbs indicate speed in 5 knot increments and can be combined on the stem to show faster winds.</p> <p>Short barb = 5 kts; Long barb = 10 kts; Flag = 50 kts</p> <p>Examples:  Calm</p> <p> 5 kts  15 kts  60 kts</p>
<p>Dew Point Spread</p>	<p> 0-4° C: Orange</p> <p> ≥5° C: Green</p>
<p>Temperature</p>	<p> <3° C: Red</p> <p> 3-34° C: Green</p> <p> ≥35° C: Orange</p>
<p>Visibility <i>(same as Flight Category colors)</i></p>	<p> <1 SM: Magenta</p> <p> 1-2 SM: Red</p> <p> 3-5 SM: Blue</p> <p> >5 SM: Green</p>
<p>Ceiling <i>(same as Flight Category colors)</i></p>	<p> <500': Magenta</p> <p> 500'-999': Red</p> <p> 1000'-2999': Blue</p> <p> ≥3000': Green</p>

Attitude Indicator / Synthetic Vision (iPad only)

Tap the Attitude Indicator/Synthetic Vision (SV) button  at the top of the Maps page to view the Attitude Indicator display showing GPS altitude (MSL), GPS ground track, GPS ground speed and GPS calculated rate of climb (ft/min). If connected to a Stratus 2/2S or other AHRS-equipped external device, the display will also include AHRS-derived horizon (pitch & roll). However if using a GPS source that does not include an AHRS sensor, then attitude information (pitch, roll) is not displayed and the horizon will appear level regardless of your aircraft's attitude.

If you have a subscription that includes Synthetic Vision (SV), the display will also include a 3D depiction of the terrain ahead of you. Obstacles and Terrain are colored based on the relative altitude (tied to the Profile view altitude selection). By default, Obstacles or Terrain more than 1000' below you are colored green; within 1000' below your altitude are Yellow; and within 100' below to above your altitude are Red. The gridlines on the SV view are aligned North-South and East-West for easy orientation.



Attitude Indicator with GPS input but no SV subscription or AHRS input.

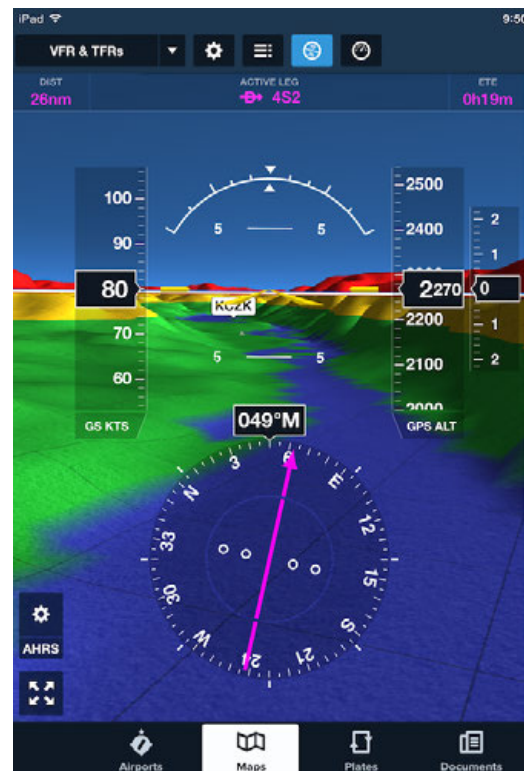

Attitude Indicator with AHRS input and SV subscription.

When the iPad is in Landscape orientation the AI/SV display is shown on the left side of the screen. When the iPad is in Portrait orientation the AI/SV display is shown at the top of the screen on the Maps page.

Tap the full-screen/half-screen button in the lower left corner of the screen to switch between split-screen and full-screen AI display in either landscape or portrait orientation.



IMPORTANT NOTICE: ATTITUDE INDICATOR DISPLAY

THE FOREFLIGHT ATTITUDE INDICATOR / SYNTHETIC VISION (AI/SV) DISPLAY IS FOR INFORMATIONAL PURPOSES ONLY. DO NOT USE THE FOREFLIGHT AI/SV DISPLAY AS A PRIMARY INSTRUMENT IN ANY PHASE OF FLIGHT.

THE FOREFLIGHT AI/SV DISPLAY SHOWS THE ATTITUDE OF THE AHRS-EQUIPPED EXTERNAL DEVICE. IF THE DEVICE IS NOT MOUNTED PROPERLY AND SECURELY IN THE AIRCRAFT, THE ATTITUDE SHOWN MAY NOT CORRESPOND TO THE AIRCRAFT'S ACTUAL ATTITUDE.

The AI display will automatically begin dimming to a darker “night” mode beginning 20 minutes before local sunset and will be fully dimmed 20 minutes after sunset. 20 minutes before local sunrise the AI display will automatically begin brightening to “day” mode.



Red chevrons are shown on the AI/SV display if the nose-up or nose-down attitude approaches 30 degrees. The chevrons point in the direction of pitch recovery.



Stratus 2/2S Positioning

For accurate pitch & roll indications the Stratus 2/2S must be positioned in the aircraft with the long axis of the device aligned fore and aft with the aircraft centerline and with the LED lights facing towards the back of the airplane. The device does not need to be mounted exactly on the aircraft centerline, and can be mounted up to 90 degrees on edge for applications such as mounting to a side window using a suction cup.

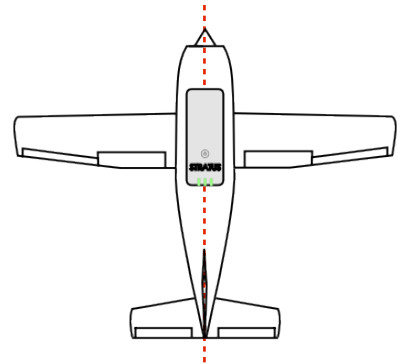

Calibrate the AI/SV display

When using a Stratus 2/2S, the Attitude Indicator can be calibrated to straight and level by tapping the AHRS “data source” label (1) in the lower-left of the Attitude Indicator display. Tap the “Calibrate” button (2) on the pop-up window and then tap on the “Zero Pitch & Bank” button (3) to automatically set the current condition as level, or tap on any of the four Pitch & Bank arrows to adjust the pitch and roll in small increments. To save the calibration tap the “Save” button (4) in the upper right corner of the display. Tap the “Cancel” button (5) to cancel the calibration.

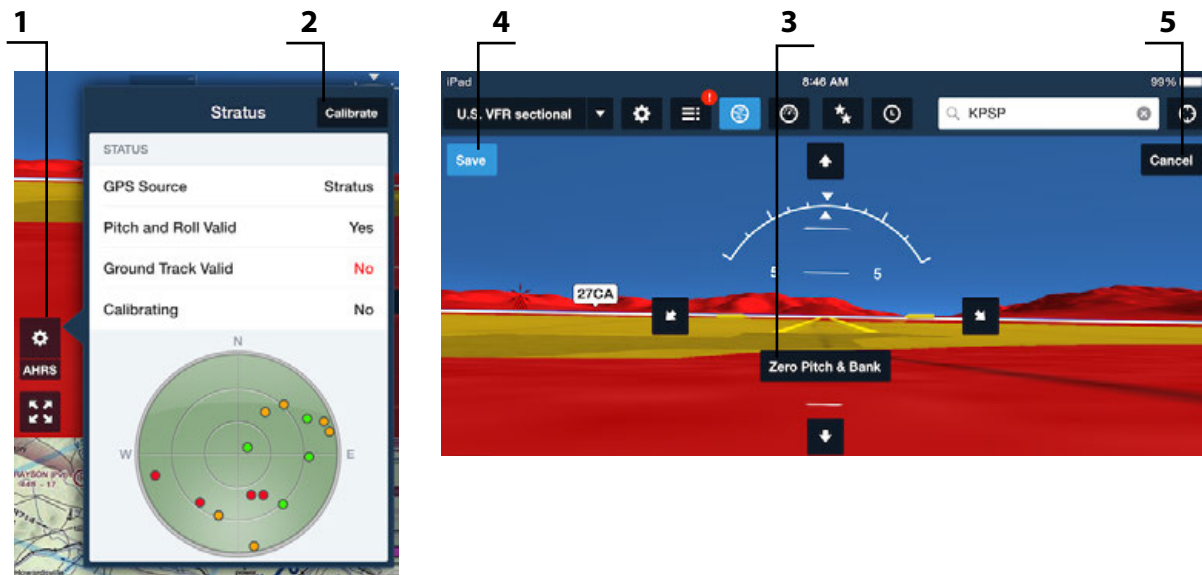

To calibrate the Attitude Indicator when using a Garmin Flight Stream 210 or Garmin GTX345, see [Calibrating Flight Stream 210 AHRS](#) and [Calibrating the GTX345 AHRS](#), respectively.

In the event that AHRS or GPS data becomes unreliable, the affected instrument(s) will be X'd out until reliable data is received.

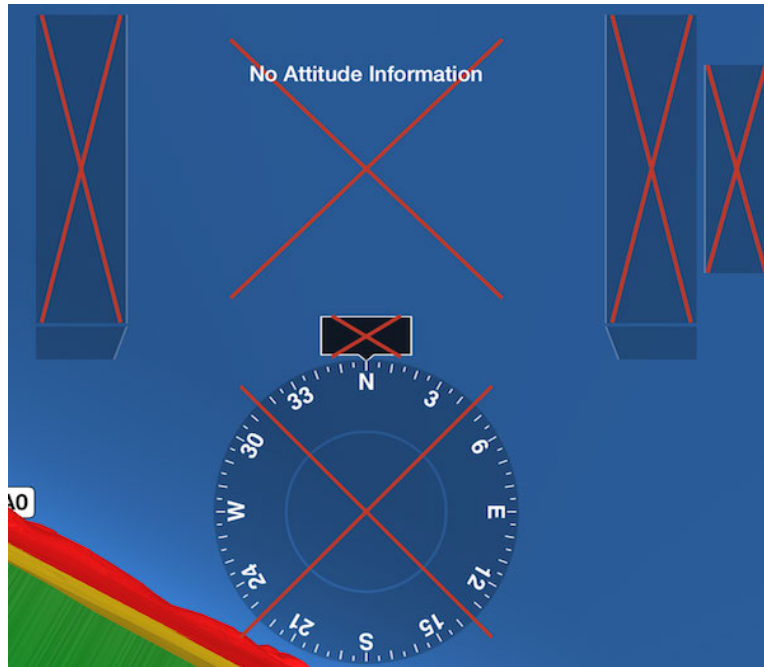

Synthetic Vision required downloads

To display Synthetic Vision terrain, you must first turn on the “High Resolution Terrain” switch in **More > Downloads > United States** (and/or **Canada** or **Caribbean, Mexico, Central America**), then tap the black <Downloads button to go back to the Download status page, and tap the blue “Download” button to download the High Resolution Terrain data, which includes the data for Synthetic Vision.

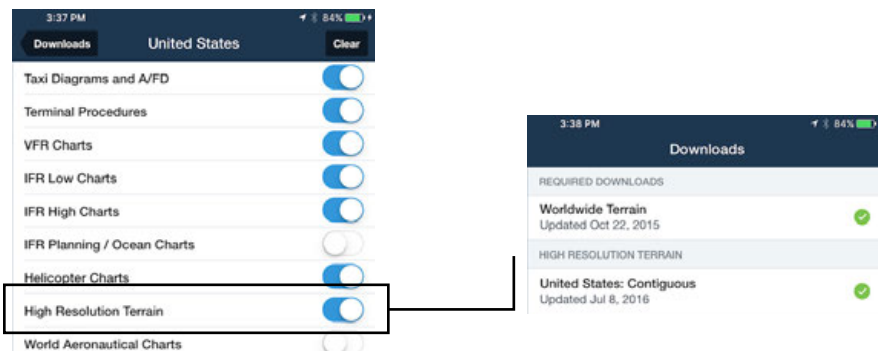

Finding an Airport, Navigation Aid, or Aircraft using Search

To quickly center the map on an airport, navigation aid, or waypoint, tap the *search box* in the top right of the view. Type the location's identifier, and tap the **Search** button on the keyboard.

You can search by identifier, latitude/longitude, or bearing and distance from a waypoint.

The waypoint will be shown with a marker. Typing in a waypoint will not clear any route showing on the Maps view.

To remove the animated waypoint marker, simply tap elsewhere on the map.

Example Searches:

- ❖ **KJFK** - Centers the map on KJFK airport
- ❖ **FLW** - Centers the map on the FLW VOR
- ❖ **32.3N/99W** - Centers the map on the latitude/longitude
- ❖ **324455/-0804557** - Centers the map on 32°44'55"N, 80°45'57"W
- ❖ **N324455/W0804557** - Centers the map on 32°44'55"N, 80°45'57"W
- ❖ **3244.92/-08045.95** - Centers the map on 32°44'55"N, 80°45'57"W
- ❖ **3244556/-08045576** - Centers the map on 32°44'55.6"N, 80°45'57.6"W
- ❖ **4952N** - ARINC 424 coordinates, centers the map at 49N 52W
- ❖ **HIGAL/320/15** - Centers the map on 15nm bearing 320°M from HIGAL. If a VOR is given as the reference waypoint, then the directional information is assumed to indicate a radial, not a bearing
- ❖ **LAX/246R/20** - Centers map on the 246 radial, 20nm from LAX
- ❖ **LAX/246M/20** - Centers map on the 246 Magnetic bearing, 20nm from LAX
- ❖ **LAX/246T/20** - Centers map on the 246 True bearing, 20nm from LAX
- ❖ **MZB293/SLI148** - Centers map on intersection of MZB's 293 radial and SLI's 148 radial

*For more information about the following SAR grid waypoint options, see the Search and Rescue Supplement in **Documents** > **Catalog** > **ForeFlight**.*

- ❖ **CAP@ORD451C** - Centers the map on the middle of CAP Grid ORD451, quadrant C.
- ❖ **CAP@40092CD** - Centers the map on the middle of CAP Cell Grid 40092CD.

❖ **GARS@176LW3** - Centers the map on the middle of GARS Grid 176LW, quadrant 3.

❖ **15RTN50008000** or **MGRS@15RTN50008000** - Centers the map on the middle of MGRS grid UTM zone 15, latitude band R, 100,000m grid square TN, easting 5000, northing 8000. MGRS coordinates no longer require entering MGRS@... before the coordinate values.

❖ **N####** or a flight eg: **ENY3961** - shows any flight that is either currently enroute, or scheduled to depart in the next 24 hours (based on currently filed flight plans) for that aircraft. Tap the entry to add that route to the NavLog.

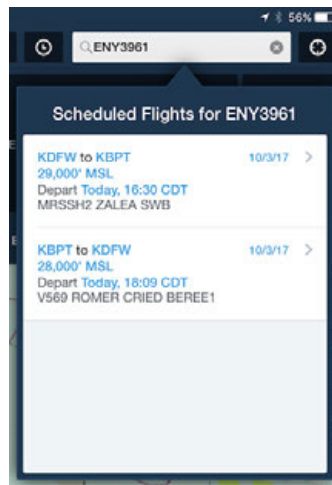

Airspace Information

To see information about Airspace, MOAs and Restricted Areas, tap-hold on the airspace or area on the Map. Airspace information is shown under the "Airspace" header. You can further highlight the airspace by tapping on its name in the pop-up. Tap **Cancel** (or anywhere on the screen) to close the pop-up.



Route Line

The route line drawn on the map is color-coded to indicate the active leg. **Magenta** is the current leg, **blue** is a future leg, and **orange** is a past leg. Waypoints in the route are drawn with an icon to represent their type, such as a VOR.

Working with the NavLog, Edit and Profile Views

Overview

Tap the FPL button in the Maps view toolbar to hide or show the Edit/NavLog/Profile views. To change between the views, tap the selectors in the lower portion of the overlay view.



At the bottom of the view is a summary of route and performance data (when available), as well as the effect of winds over the entire route. Winds are only incorporated if a true airspeed and altitude are provided as part of the route.

Winds aloft calculations also require an active network connection to retrieve the latest winds aloft forecast. However, once a forecast has been downloaded it will be saved for a few hours for use when offline.

To see your route without wind adjustments, enter an ETD more than 48 hours ahead.

The suitcase button  displays the Pack menu. Pack offers a 1-step method of downloading all chart, weather, TFR and fuel-price data needed for the route of flight currently in the Route Editor.

The star button toggles the favorite status of the current route. When the star icon is orange , the current route has been saved as a favorite. When marking a route as a favorite, you have the opportunity to name the route as something other than the default “<Origin> to <Destination>” name; having a custom name can be helpful when locating a route in the Favorite Routes list.

The rectangle-with-arrow button  is the **Send To** button. Tapping this will show multiple options:

- ❖ "Mail" creates a new email message with your navigation log and a screenshot of your trip. The message also includes a link that other ForeFlight Mobile users can tap to load your route onto their iPad or iPhone. **Note:** this option only appears if an email account is set up in your device's Mail app.
- ❖ "Flights" copies the current route and performance data to an empty flight plan on the Flights view. *Note:* tapping this button does not directly file the flight plan or submit a request for a briefing.
- ❖ "Logbook" creates a new entry in [ForeFlight Logbook](#) and auto-fills it with the current route, aircraft, and estimated time enroute. **Note:** this option only appears if you have a subscription that includes Logbook.
- ❖ "Print" allows printing of the navigation log to a connected AirPrint printer. (Requires iOS 4.2 or higher.)
- ❖ "Clipboard" will copy the flight plan to the iPad internal clipboard to allow "pasting" in another application.
- ❖ Other devices on the same WiFi network that are running ForeFlight (listed by device name). See [Cockpit Sharing](#).
- ❖ Other - includes Social Media, such as:
 - ❖ "Twitter" composes a new Twitter message with your route and a screenshot of your trip. (Requires iOS 5 or higher, plus Twitter account setup in Apple Settings.)
 - ❖ "Facebook" composes a new Facebook post with your route and a screenshot of your trip. (Requires iOS 5 or higher, plus Facebook account setup in Apple Settings.)
- ❖ "LogTen" sends a copy of your route to the LogTen logbook app, if installed on your device.
- ❖ "Aspen" will copy the flight plan to your Aspen Connected Panel.

Flight Plan Editor

The Flight Plan Editor allows for easy creation and editing of routes on the iPad. To create or append to a route, simply tap the center area and use the keyboard to enter the new route element. Any route element accepted via the Search input is valid in the Edit View, including airways and SIDs/STARs. As you make changes to the entries, the Map and Route Editor will update to reflect the new route.

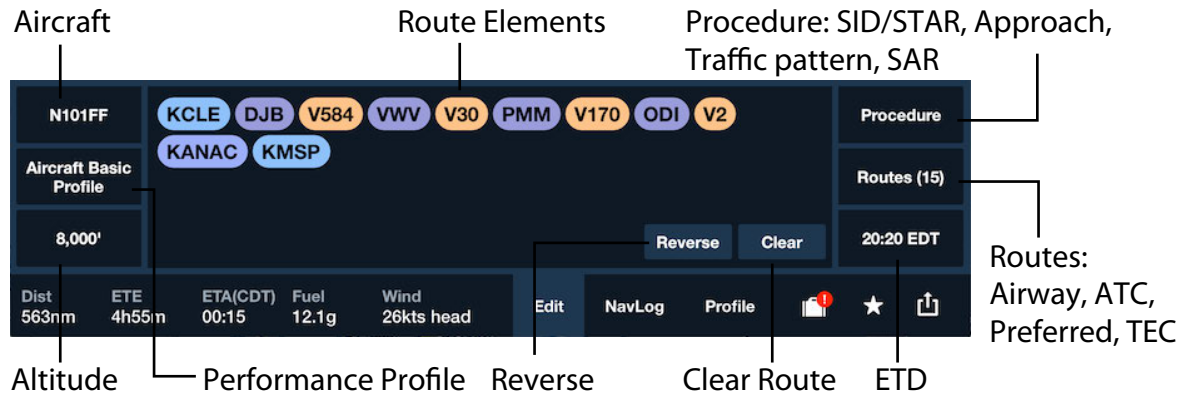

The Route Elements are color-coded for easier identification:

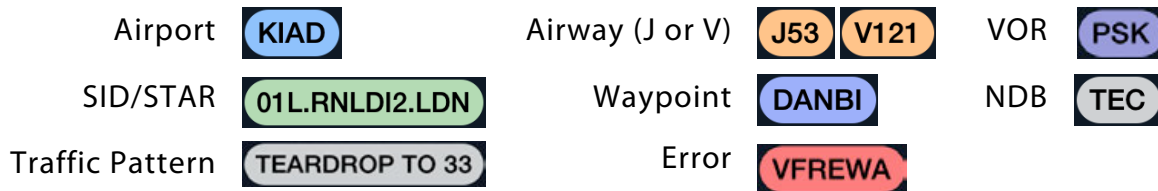

Tap the Performance Profile button to choose the performance profile to apply to your flight. You can also override any profile information by typing a cruise speed, fuel burn, and/or altitude into the Route Editor. **NOTE:** Climb, Cruise and Descent performance information can also be entered into a Custom Performance Profile for your Aircraft on the **More > Aircraft** page.

Multiple Custom Performance Profiles can be created for each aircraft, and you can select between them by tapping the Performance Profile button.

When there is a large difference between your aircraft's climb speeds and fuel burns and cruise speeds and fuel burns, depending on the length of the flight you may see a meaningful difference in total time and fuel burns when using "Detailed"

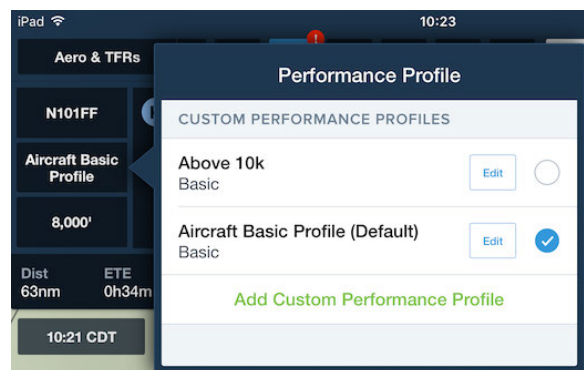

information (Climb, Cruise, and Descent speeds and fuel burns) instead of only an average fuel burn and speed. In the table below you can compare the time and fuel burn results for three different routes planned with “Detailed” (with all aircraft performance information entered) and “Simple” parameters.

Route	“Detailed”	“Simple”
(winds included)	<i>Climb: 100 kts, 20 GPH, 500 ft/min Cruise: 145 kts, 13 GPH Descent: 145 kts, 9 GPH, 500 ft/min</i>	<i>Fuel burn: 14.5 GPH Speed: 145 kts</i>
KMIC - KFAR (182nm) at 8000'	18.6 gallons, 1h23m	19.1 gallons, 1h19m
KPAO - KSMO (273nm) at 11000'	31.2 gallons, 2h09m	29.5 gallons, 2h02m
KHOU - KERP (587nm) at 6000'	60.8 gallons, 4h09m	59.9 gallons, 4h08m

Performance Plus subscribers have access to advanced aircraft performance profiles developed by ForeFlight using aircraft manufacturer data. For additional details, see the Performance in ForeFlight Mobile guide, or visit www.foreflight.com/pricing to upgrade your subscription to Performance Plus.

The Altitude button displays the Altitude Advisor™ which shows the modeled winds aloft at various altitudes, provided the required route and performance data are available. Altitudes resulting in a net average tailwind over the route are shown in **green**, while those resulting in a net average headwind are shown in **red**. Airports included between the departure and destination in the Route Editor are treated as navigation waypoints, so the calculated time and fuel burn do not include descending to and climbing up from those airports.

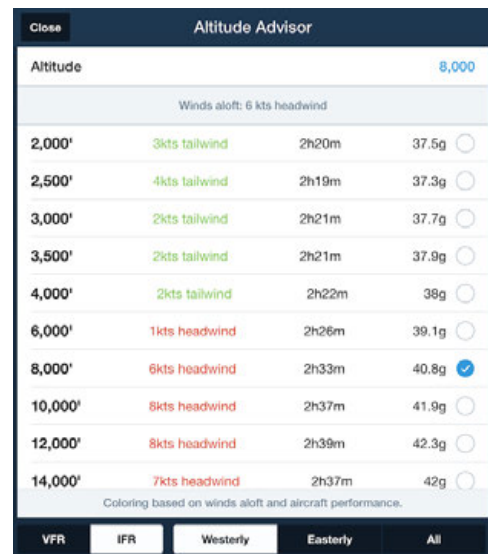

If you have entered your aircraft’s [Climb performance](#) on the More > Aircraft page, the Altitude Advisor will automatically calculate whether it is possible to reach the listed altitude based on your aircraft’s rate of climb and the distance of the route.

NOTE: If it will not be possible to reach an altitude given your aircraft's performance, the current winds, and time available before needing to descend, the Altitude Advisor will show "-----" for that altitude's row.

When connected to a Stratus ADS-B receiver or SiriusXM SXAR1, Altitude Advisor™ will only display wind effects if you have received recent winds aloft data for the entire route.

Procedure Advisor

The Procedure button in the top right of the Flight Plan Edit view opens the Procedure Advisor allowing you to add or replace Arrival procedures (STAR), Departure procedures (SID), Approaches, VFR traffic patterns and Search & Rescue (SAR) patterns in the route.

Departures, Arrivals, Approaches and Traffic Patterns require that at least one airport be entered in the Route Editor. SAR patterns can be entered without an airport in the Route Editor.

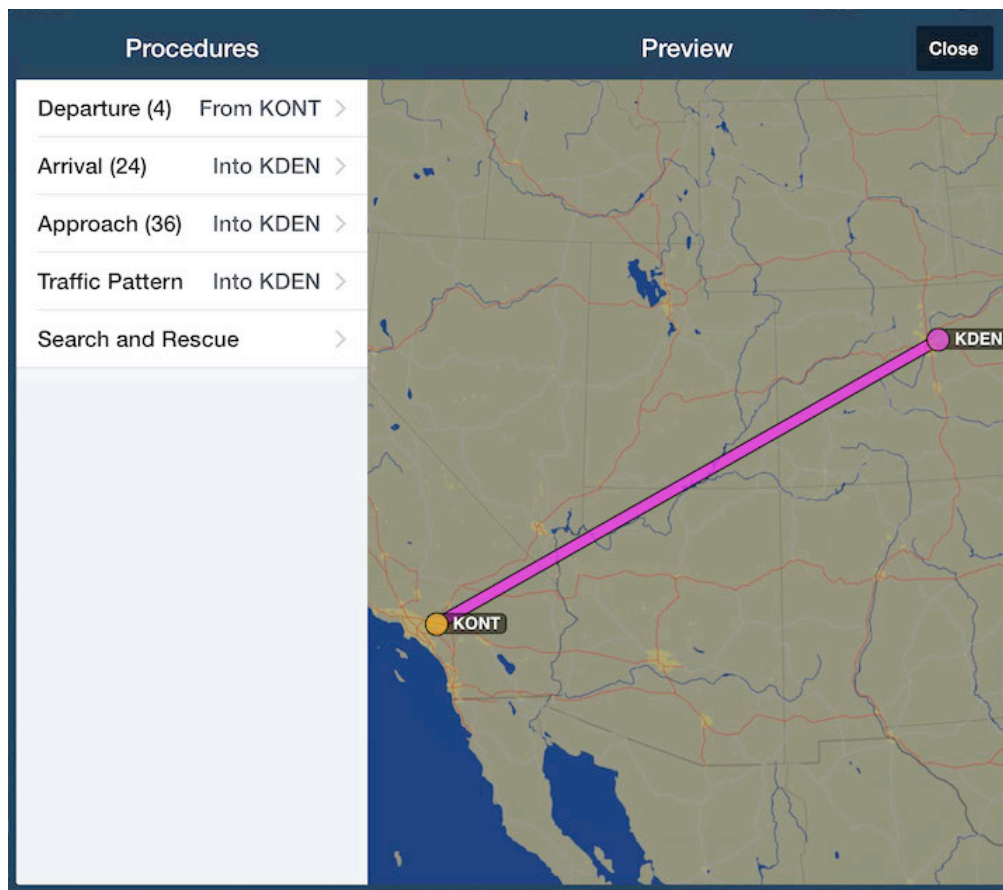

Departure

Tap **Departure** to see an inset map of the different SIDs available from the airport. The inset map can be panned and pinch-zoomed so you can see details of the different SIDs.

Tap a Departure name in the list on the left, or tap the boxed name on the inset map to see all of the transition options for that SID.

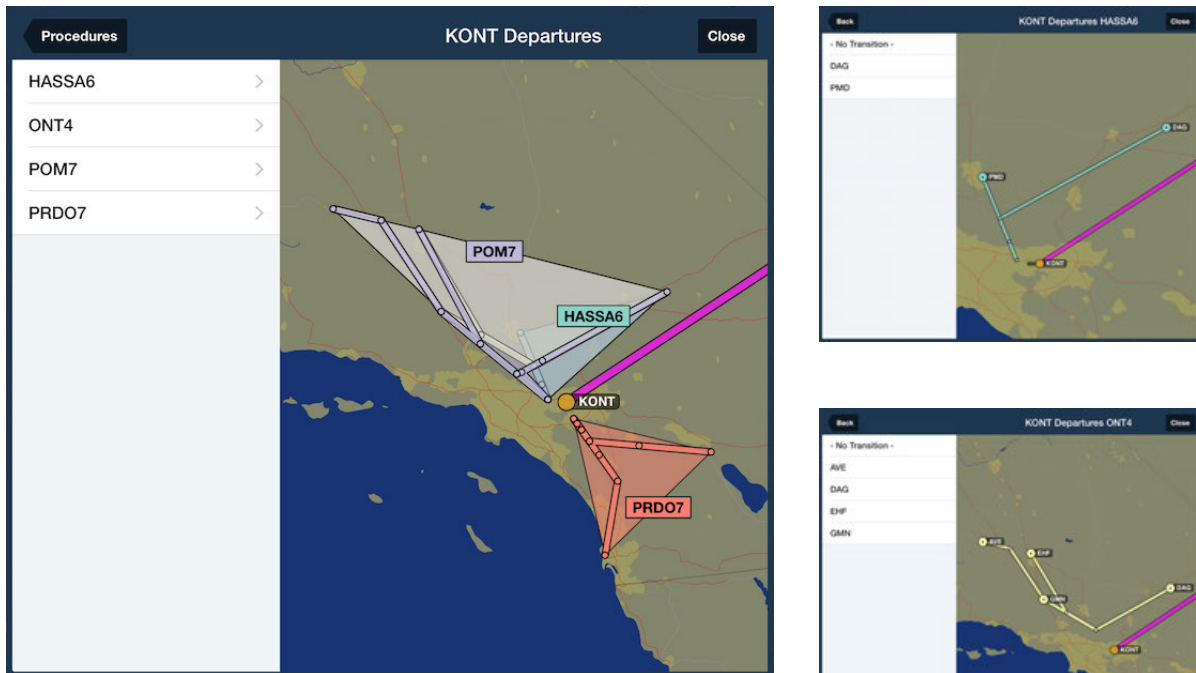

Then tap the Transition (and runway if required). When the desired SID, Transition and runway (if needed) are displayed, tap “Add to Route” to insert that SID into the route.

After adding a SID the Procedure Preview stays open so you can add additional elements to your route, such as an Arrival or an Approach.

To close the Procedure Advisor window and return to the Maps view, tap “Close” or tap anywhere not on the Procedure Preview window.

Once the Departure has been added you can change it or the selected runway by tapping the colored Departure oval in the Route Editor and choose **Change Departure...** or **Change Runway...**

Arrival

Tap **Arrival** to see a map of the different STARs available at the destination airport. As when adding a SID, tap an Arrival name in the list on the left, or tap the boxed name on the Preview map to see all of the transition options for that STAR.

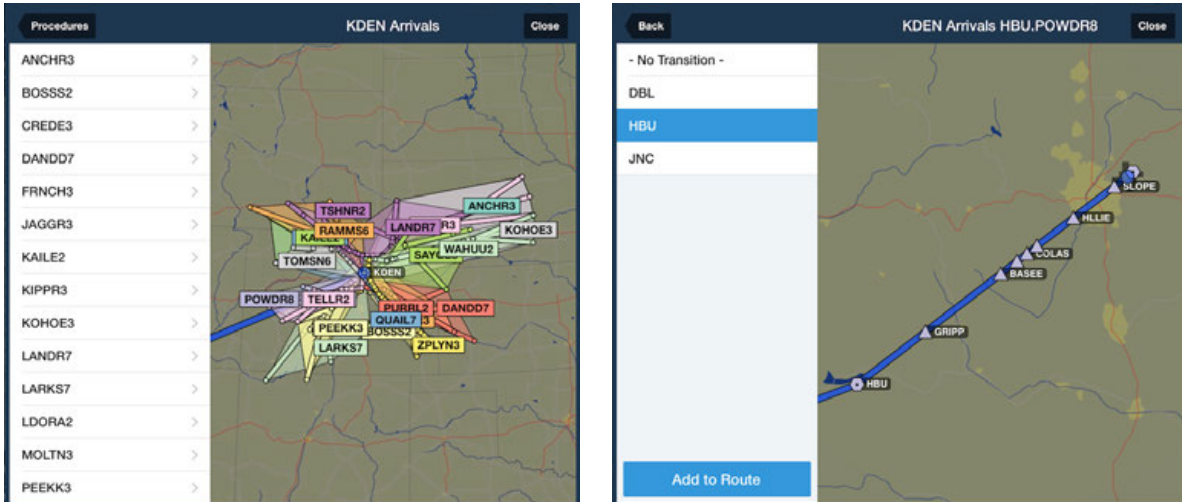

If the list of Arrivals is longer than the Procedure Preview window, scroll down to see the remaining Arrivals. Then tap the Transition (and runway if required). When the desired STAR, Transition and runway (if needed) are displayed, tap "Add to Route" to insert that STAR into the route.

Once the Arrival has been added you can change it or the selected runway by tapping the colored Arrival oval in the Route Editor and choose **Change Arrival...** or **Change Runway...**

Approach

Tap **Approach** to see the available approaches for that airport. If a current METAR is available, the runways with the most favorable winds are highlighted in the list.

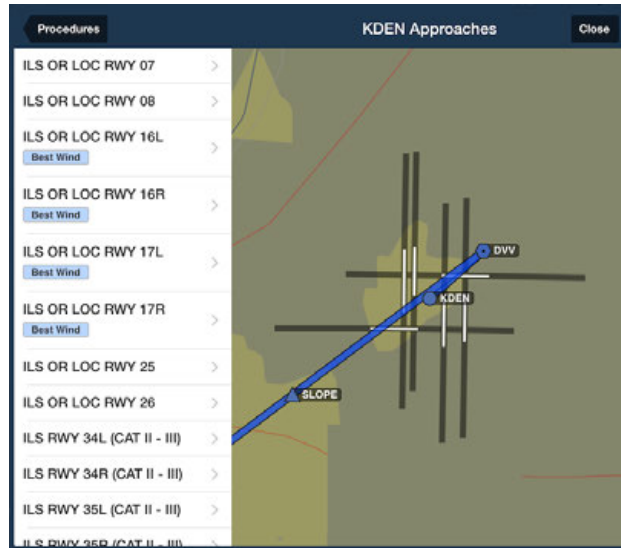

Tap an Approach to see the preview including the available IAFs. Choose an IAF by tapping in the list on the left, or on the Maps page, then tap "Add to Route."

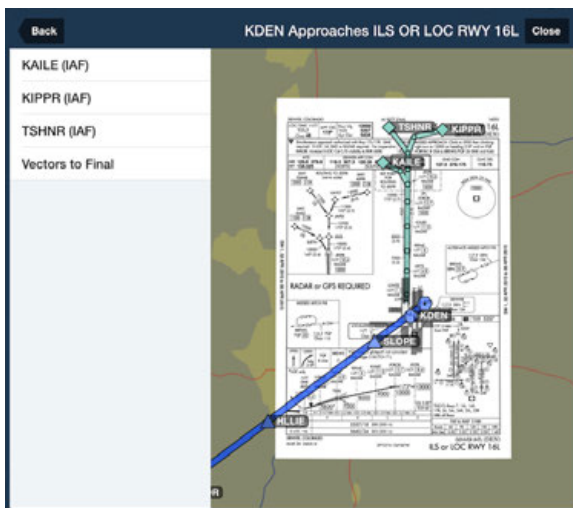

If you have a **Pro** or greater subscription plan, the plate associated with a given approach will automatically appear on the inset map when you select the approach. If adding an approach for which you have Jeppesen charts, a "Select Plate" popup will appear for approaches that have multiple plates associated with them (such as ILS or LOC, ILS CAT I, and ILS CAT II & III), allowing you to select which plate will appear on

the map. When you make your selection the name of the approach on the previous list of approaches will be updated to match your selection.

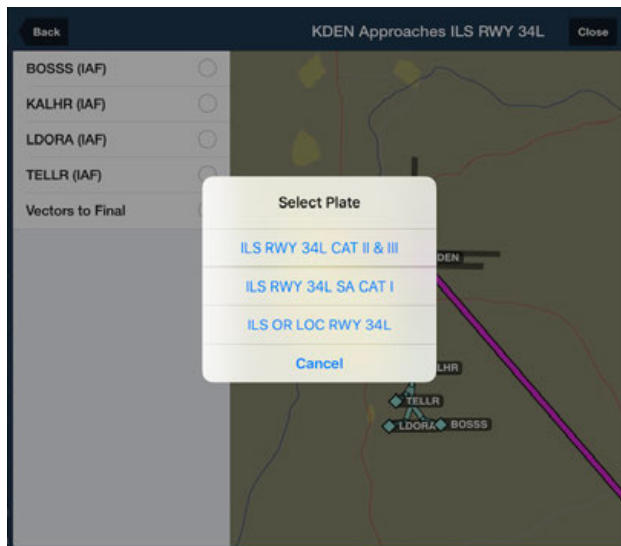

When you close Procedure Advisor after adding an approach for which you have the plate, and you have a **Pro** or greater subscription plan, the plate will automatically be added to the map.

Once the Approach has been added you can change between approaches or IAFs by tapping the Procedure Advisor button again and selecting a new Approach. Or tap the colored Approach oval in the Route Editor and choose **Change Approach...** or **Change IAF...**

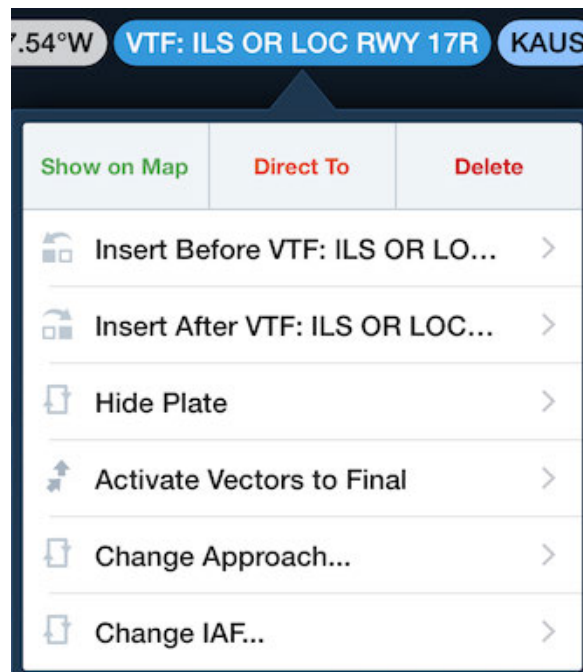

If an Approach entry includes a hold, ForeFlight Mobile will automatically insert the correct Direct, Parallel, or Teardrop entry based on the direction you're coming from.

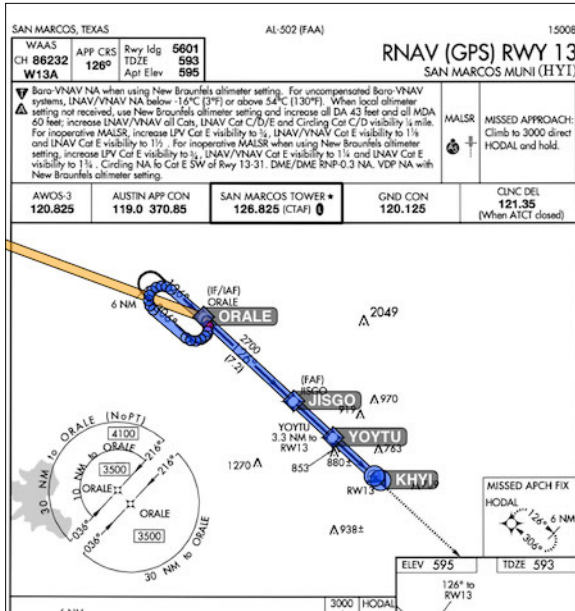

Direct Entry

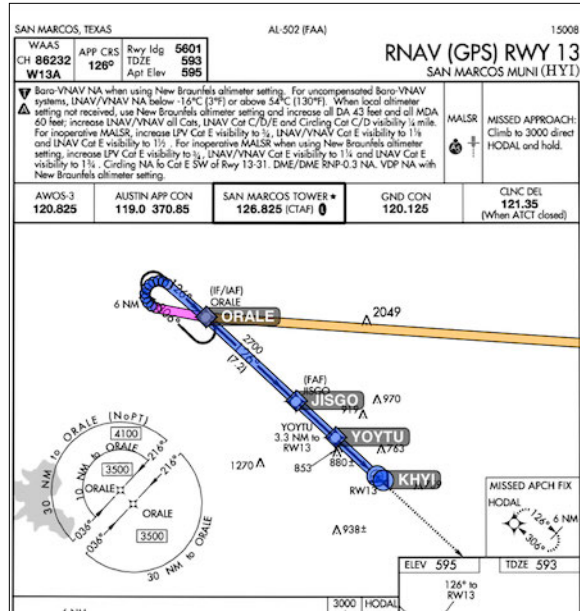

Teardrop Entry

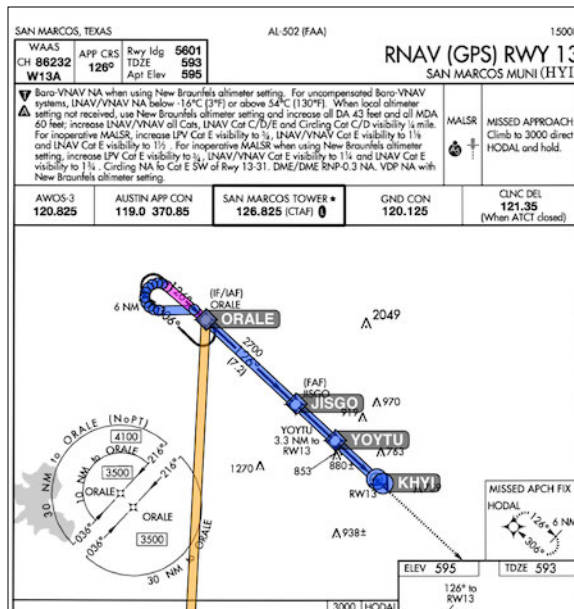

Parallel Entry

Activate Vectors to Final

Activate Vectors to Final erases any existing IAF, draws a light magenta 30nm extension from the FAF, and plots a direct-to route from your present position to a point 3nm outside the FAF. You can reactivate Vectors to Final anytime to redraw the line from your current position to the point 3nm from the FAF.

Tap the colored Approach oval in the Route Editor and choose **Activate Vectors to Final** or tap the Procedure Advisor button and re-select the approach and choose Activate Vectors to Final.

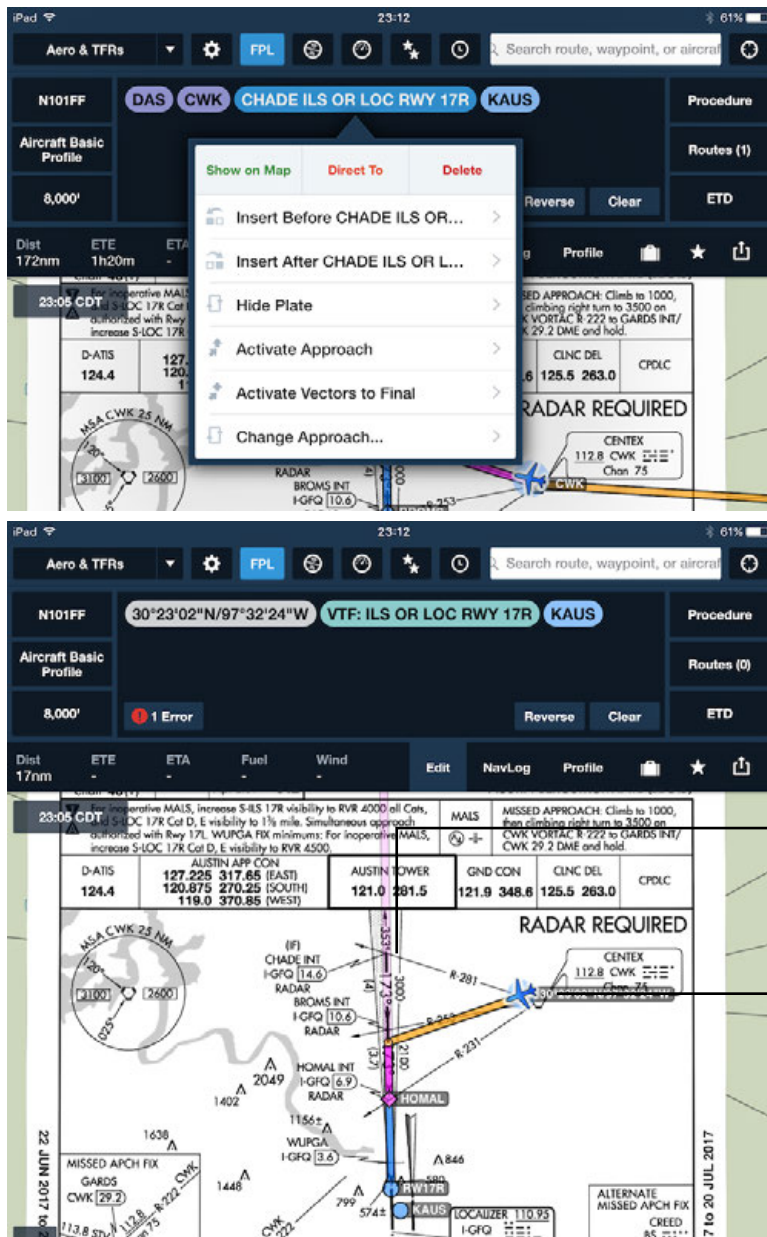

Traffic Pattern

Tap the **Procedure** button, then tap **Traffic Pattern** to display VFR traffic patterns for the airport at the end of the current route. If current winds are available, the runway selections with the best winds are highlighted in the list. Wind direction, speed and age of observation are also shown at the bottom of the list (scroll down if necessary to see the winds).

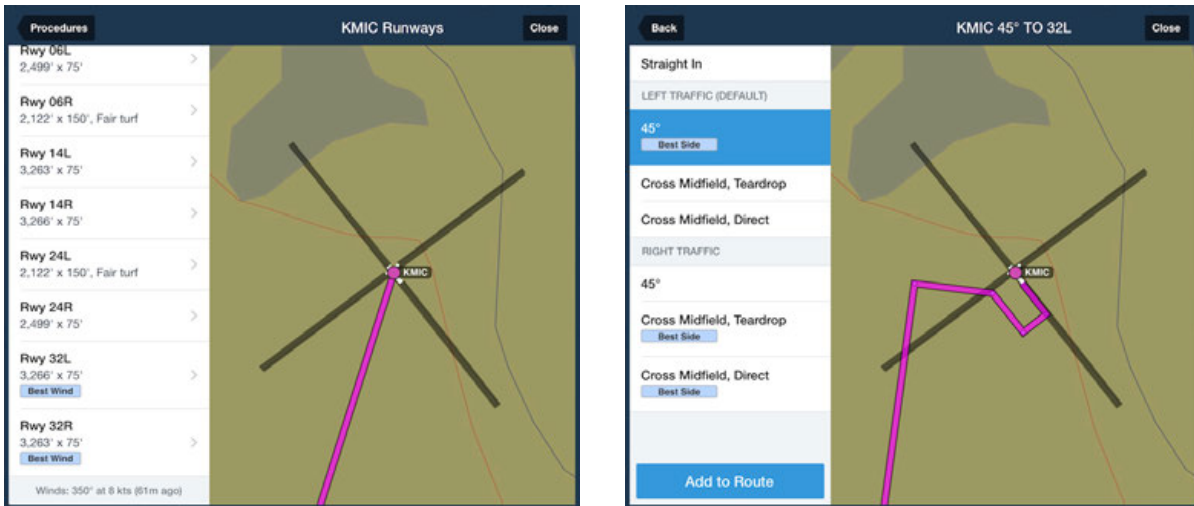

After selecting a runway the available pattern entry options are displayed, such as Cross Midfield or Straight-in. For non-towered airports the entries are sorted based on each runway's pattern side (right or left).

Additionally, entries are highlighted that make the most sense for your route's direction of flight. Tap an entry to add it to the end of the current route (or to replace one already in the route). Traffic patterns are automatically removed from a route when certain route edits are made, such as reversing the route.

IMPORTANT: Traffic patterns cannot currently be sent to another device via [Cockpit Sharing](#).

Search and Rescue

On the iPad, **Search and Rescue** (SAR) patterns can also be inserted using the **Procedure** button (when the Enable Search and Rescue setting is ON). For more details about SAR features, see the Search and Rescue Supplement, in **Documents** > **Catalog** > **ForeFlight**. SAR patterns created on an iPad can be sent to an iPhone, but cannot be created on an iPhone.

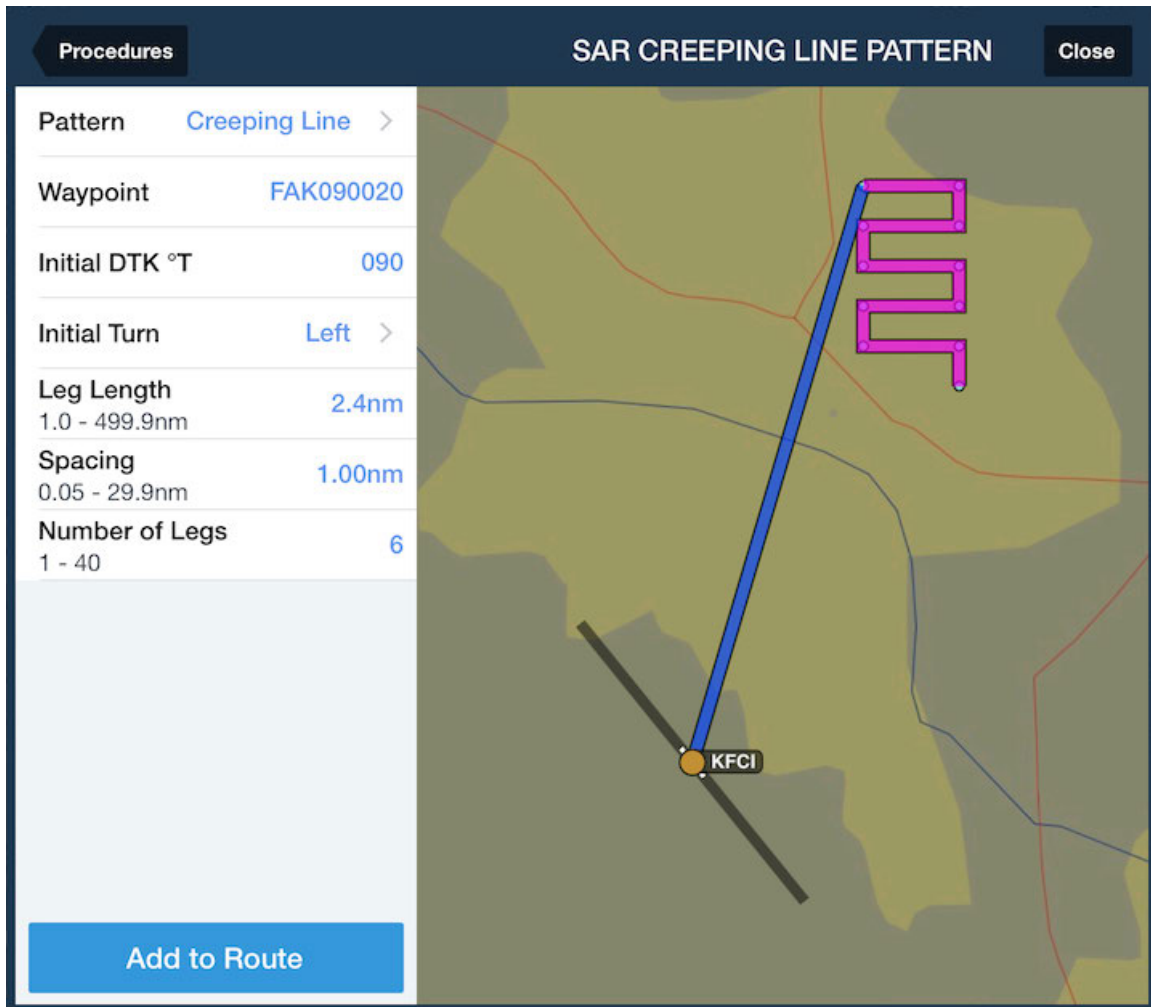

Reverse

The Reverse button reverses the current route, and removes SIDs, STARs and Approaches.

Route Advisor

The Routes button opens Route Advisor, which displays a list of potential routes that you can select for a pair of departure and destination airports. To the right of the list is a Route Preview, showing the path of every route on an interactive map. Tap on a route in the list to highlight it on the map. You can pan and zoom around the Route Preview map and tap the Zoom to Route button in the bottom left to return to a view of the full route. Tap Select Route after tapping on a route in the list to add the route in the Route Editor. This will replace any route that is already there.

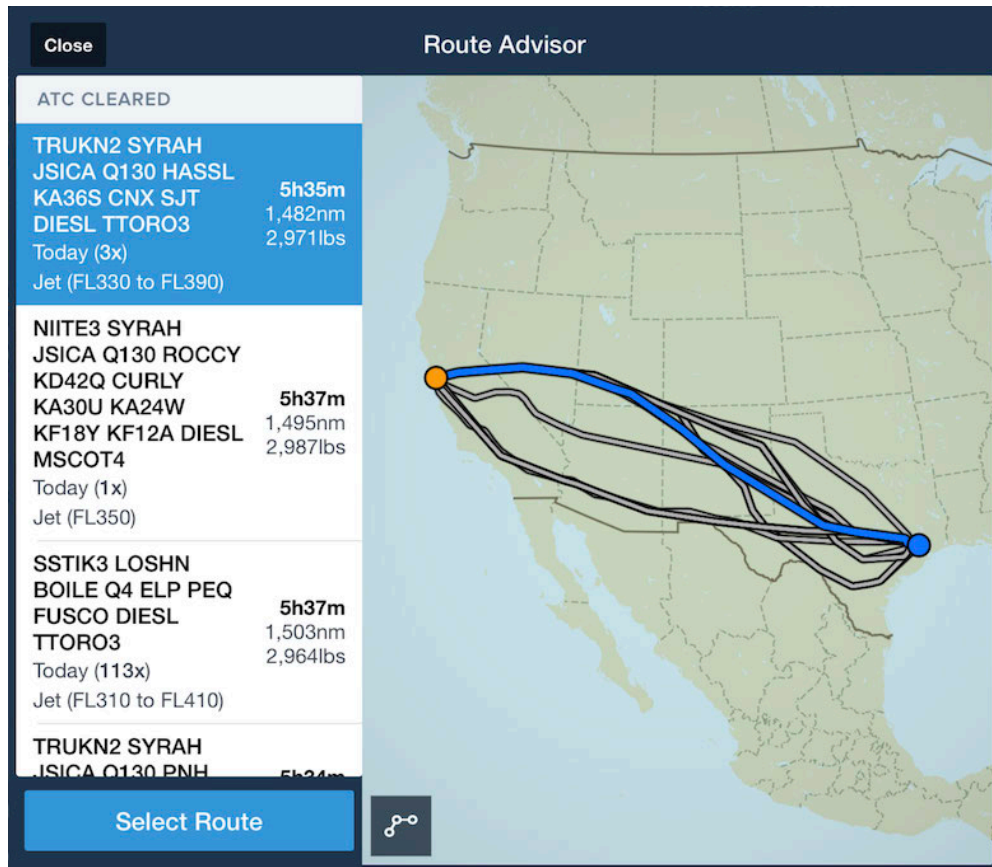

When a Performance Profile has been selected, the estimated time enroute and fuel burn based on that profile are shown for each route on the right, along with the route's total distance.

Route Advisor requires an internet connection to load new routes for an airport pair, but once those routes are loaded they can be viewed offline as long as the same departure and destination airports are entered in the Route Editor.

Types of routes shown include:

- ❖ **AviationCloud Autoroute (Performance Plus only)** - this is a special wind- and temperature-optimized route that can be generated for any airport pair in the world. See the Performance Planning in ForeFlight Mobile guide for more information.

- ❖ **ATC Cleared** - these are routes that ATC has cleared in the recent past. These show the departure time of the most recently-cleared flight, the number of times a route has been cleared in the past year, and the type of aircraft and clearance altitude for which the route was given.

- ❖ **TEC/Preferred** - these routes are commonly used and may include an altitude or range of altitudes that are typically given with the route.

- ❖ **Airway** - these are victor-airway based routes.

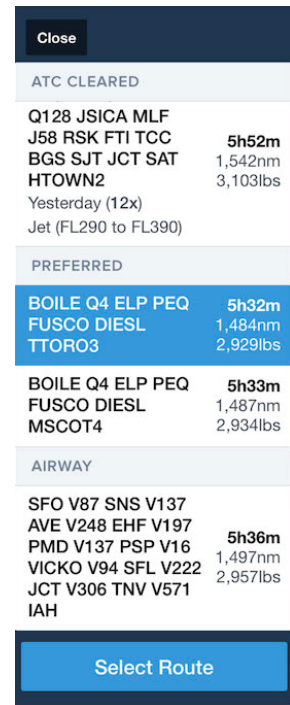

For any route that passes through Eurocontrol airspace, Route Advisor will evaluate the route against Eurocontrol’s complex system of route constraints and display a “Eurocontrol Valid” or “Eurocontrol Invalid” label beneath the route.

Route Editor

The Route Editor is used to add, reorder, or remove route items. A route item is any airport, navaid, waypoint, airway, or other route element. To add an item to the end of the route, tap anywhere in the dark blue area of the Route Editor. This will show the keyboard. Type in the ID of the route entry to add.

To add a route item in the middle of the route, tap any existing item to display the action menu for that item.

Tap either of the insert buttons to show the ID entry field. Type in the new entry to add and press Insert or tap the return key on the keyboard.

To jump to an entry on the Map, tap the entry and tap the “Show on Map” button.

To go Direct-To a route entry, tap it and tap the “Direct To” button.

To remove an entry, tap it and select Delete. Alternatively, you can hold your finger on the entry

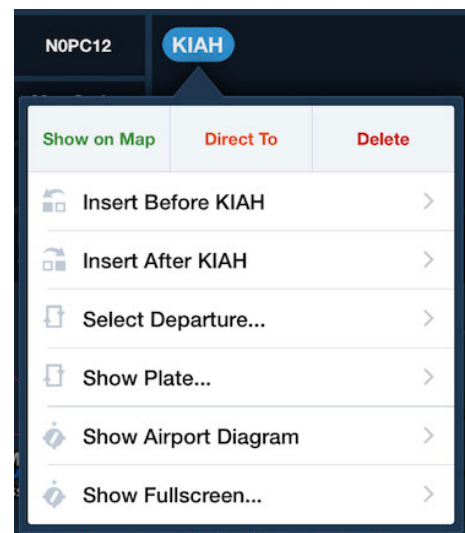

briefly to “pick it up.” Then drag it out of the Route Editor and release it to delete it.

To move an entry, touch-hold on it to “pick it up” then move it to the new location and lift your finger to “let go.”

NavLog View

The navigation log displays each leg of the route, with course (or heading, if winds aloft are included for your route), distance, fuel burn, and time statistics.

The table listing shows the start and end points of each leg, along with the leg statistics. You can select whether to display only Totals columns, only Leg columns or Both Totals and Leg columns (as below) in **More > Settings > Nav Log Columns**.

FROM	TO	HDG	TOTALS	LEG	REMAINING	ETA
PRUDE	JENEY	246°M	68nm 11.5g	0h43m 8nm 1.1g	4m13s 3.3nm	1m25s 19:09
JENEY	MOAKS	246°M	74nm 12.3g	0h46m 6nm 0.8g	3m10s 9.3nm	4m01s 19:11
MOAKS	BRNIE	246°M	75nm 12.6g	0h47m 2nm 0.2g	0m56s 11nm	4m47s 19:12
BRNIE	WUISPI	246°M	78nm 12.9g	0h48m 3nm 0.3g	1m20s 14nm	5m53s 19:13

Dist 279nm ETE 2h38m ETA(CDT) 21:58 Fuel 39.2g Wind 21kts head Edit NavLog Profile

❖ **Planned Data:** Information in the *From, To, Heading (or Course), Totals, and Leg* columns represent the *planned* route and is based on the information provided in the *Search* box, or based on your selected aircraft’s performance profile. This information is *not* updated once displayed.

❖ **Real-Time Distance, ETE/ETA:** The *Remaining* and *ETA* columns are updated in real-time based on current GPS position and groundspeed. The distance remaining on the leg, estimated time enroute for the leg, and estimated time of arrival at the next waypoint are displayed.

NOTE: during pre-flight planning on the ground, the *Remaining* and *ETA* columns will not show accurate information, because they require actual (real-time) GPS speed and position to update.

Tap on a waypoint ID in the table to jump to that waypoint on the map.

Tap the arrow button  to adjust your route to any leg, or direct to a waypoint on a leg.

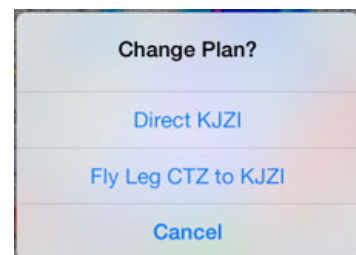

Profile View

While planning your flight, the Profile view (iPad only, Pro or greater subscription required) shows a cross section with your planned altitude relative to the terrain and obstacles within a selectable-width corridor along your planned route of flight (default is 2nm-wide: 1nm on either side). In flight, the Profile view automatically switches to show obstacles and terrain 50nm ahead of your current location. US Obstacle and Terrain data must be downloaded to the iPad to use Profile view.

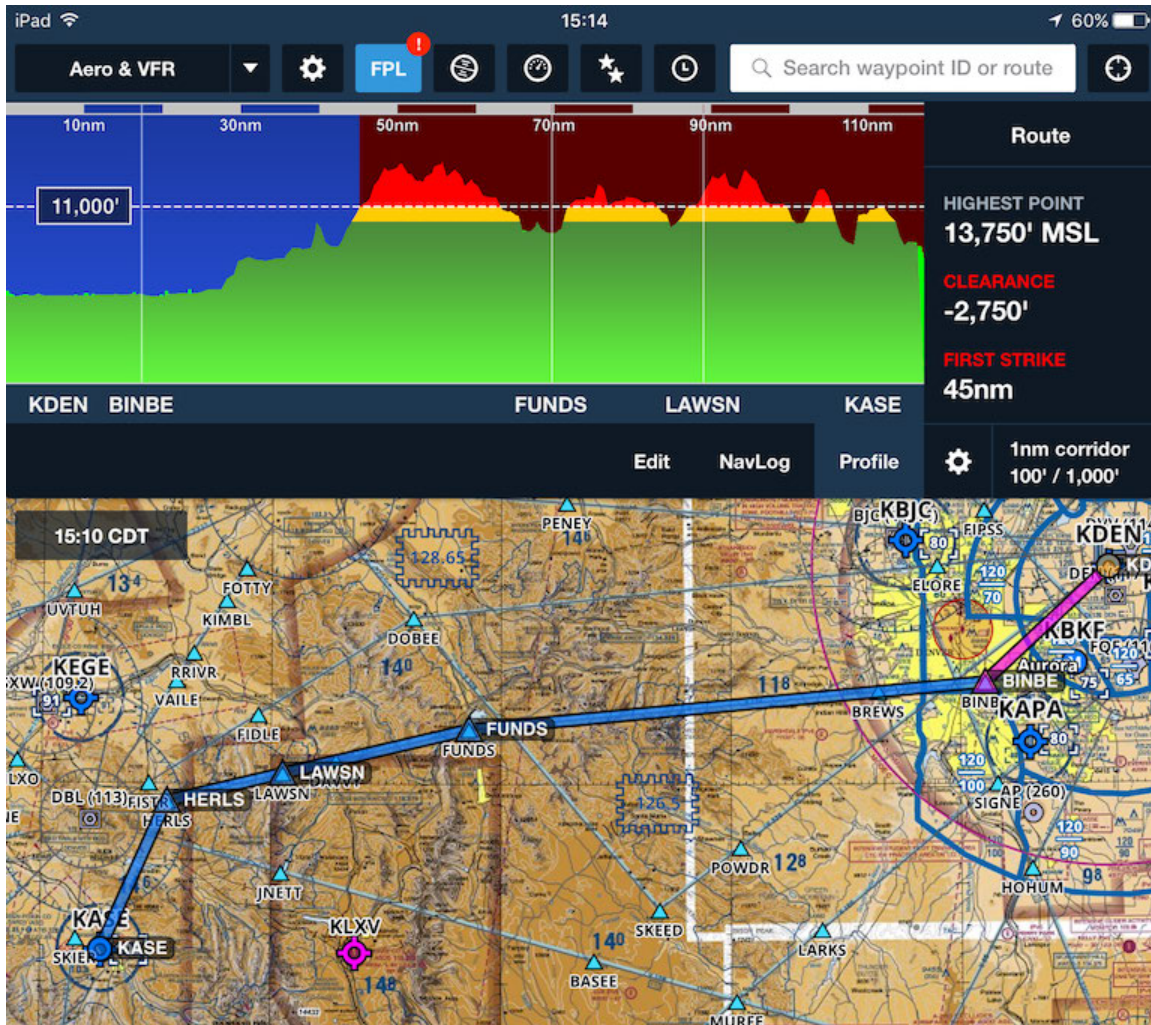

By default, the terrain profile is colored **green** in areas where there is more than 1000' clearance between your planned altitude (or actual altitude while airborne) and terrain/obstacles. The terrain profile changes to **yellow** for those areas where the terrain/obstacle clearance is between 100' and 1,000'. The terrain profile changes to **red** in those areas where there is less than 100' terrain/obstacle clearance or where the terrain/obstacle is above your planned or actual altitude.

After you enter a route in the Route Editor, tap the Profile button at the bottom of the Flight Plan Editor to display a cross-section of the terrain and obstacles along the chosen route.

Waypoints along your route are depicted as thin vertical white lines with the waypoint identifier displayed along the bottom of the profile view beneath the vertical line.

Adjust the planned altitude by touching the altitude block on the left side of the Profile view and sliding it up or down as desired. If your proposed altitude along your route intersects an obstacle or terrain ahead, the sky area will change from **Blue** to **Red**, the Clearance numbers will display in **Red**, and the First Strike section will indicate how far away (in nautical miles) from your present position the conflicting terrain or obstacle will intersect with your proposed altitude.

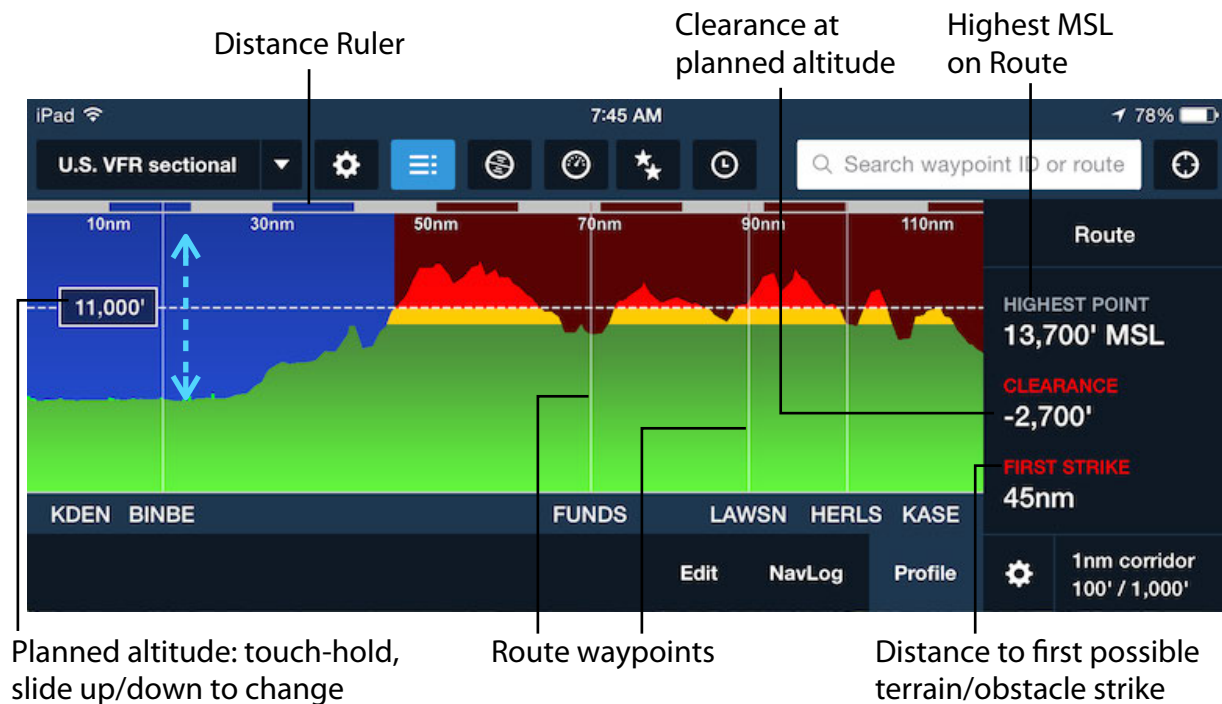

If the route is in the US, you will also see obstacles depicted along the route as thicker vertical lines. The obstacles are displayed to scale based on their altitude AGL.

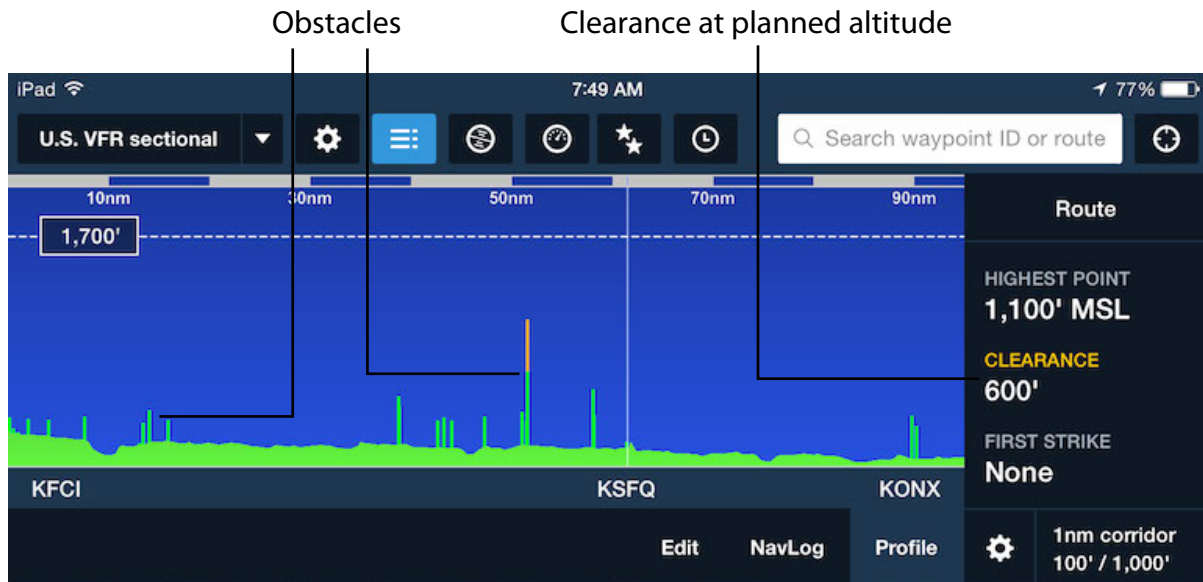

Corridor Width / Alert Altitudes

Tap the gear button to the right of Profile to choose different total corridor widths. Any obstacle or terrain feature within the selected corridor width centered on the route will be shown on the Profile view.

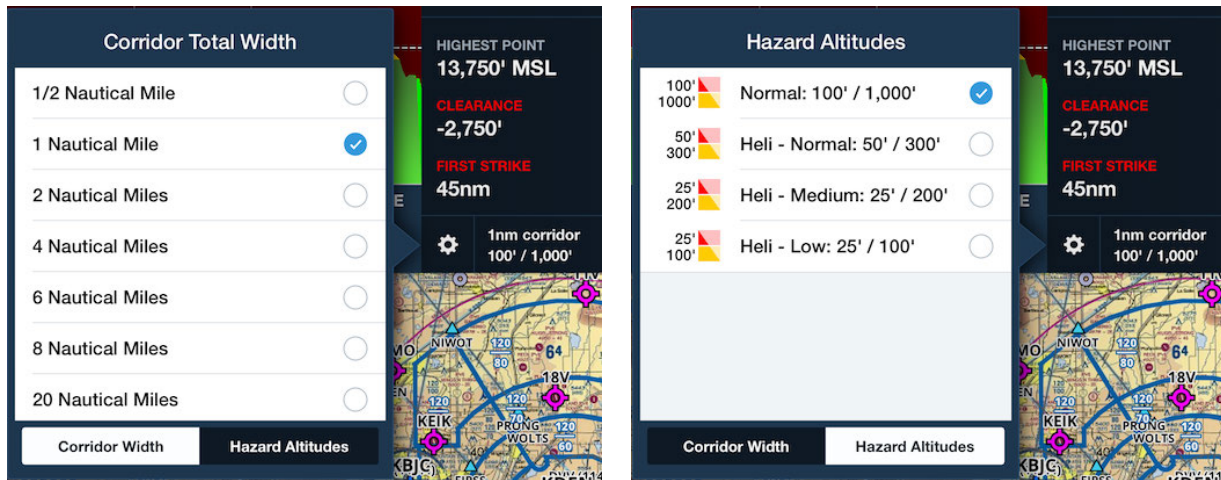

Choose the Hazard Altitude to select the relative altitudes from your aircraft for terrain & obstacle yellow & red warnings for the Profile view and Hazard Advisor.

Zoom in/out

The default Profile view automatically scales to show your entire route. To zoom in on an area of interest, touch two fingers to the Profile view then slide them apart horizontally. Pinch them together to zoom out.

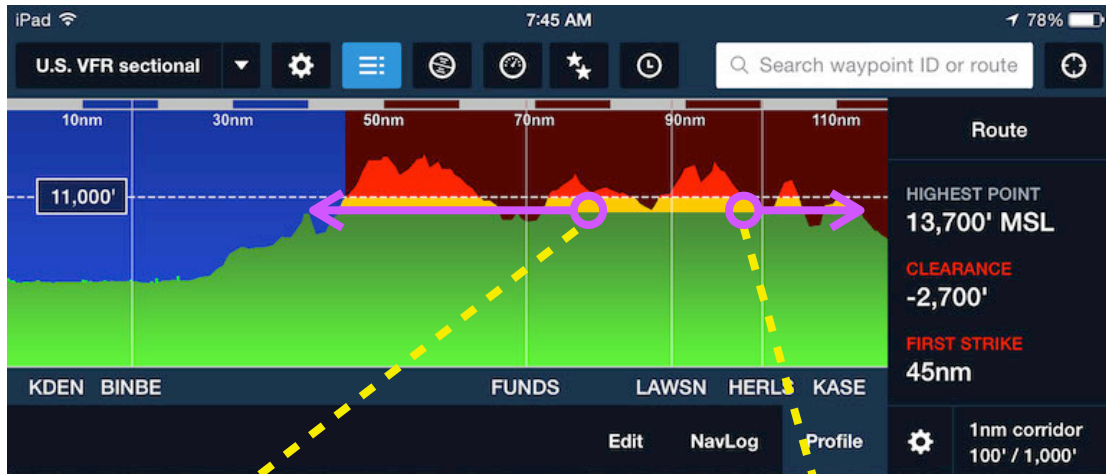

Slide two fingers apart horizontally to zoom in

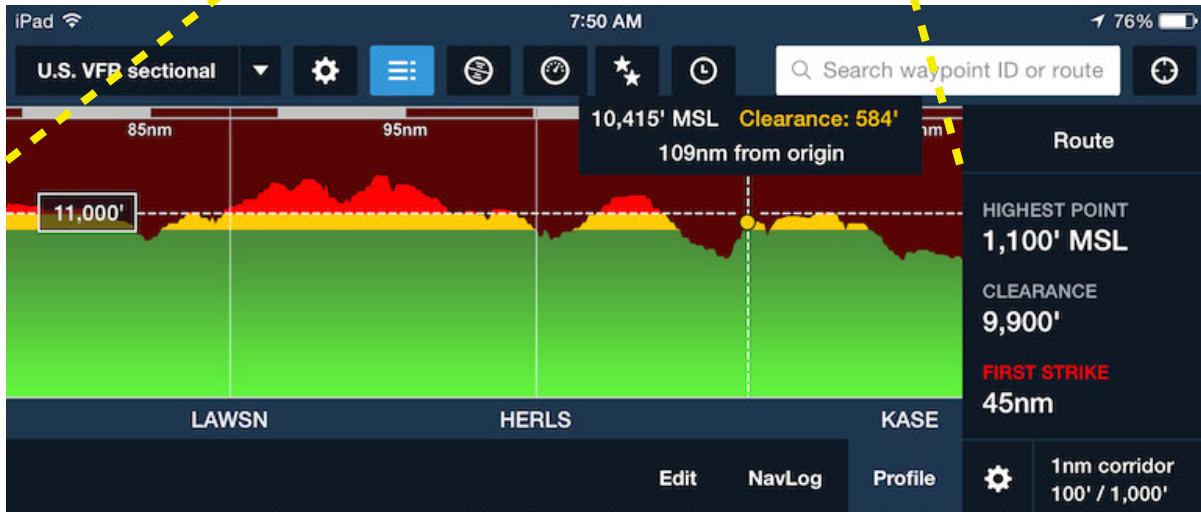

Show altitude by “scrubbing”

Touch and hold a single finger anywhere in the Profile view to open a pop-up display with altitude and clearance details for that point. A colored icon (dot) is displayed along the route line at that location. Scrub (drag) a finger left or right across the Profile view to view the terrain clearance at your desired point.

Touch and Scrub (drag) 1 finger across profile to see altitude, clearance and distance from origin

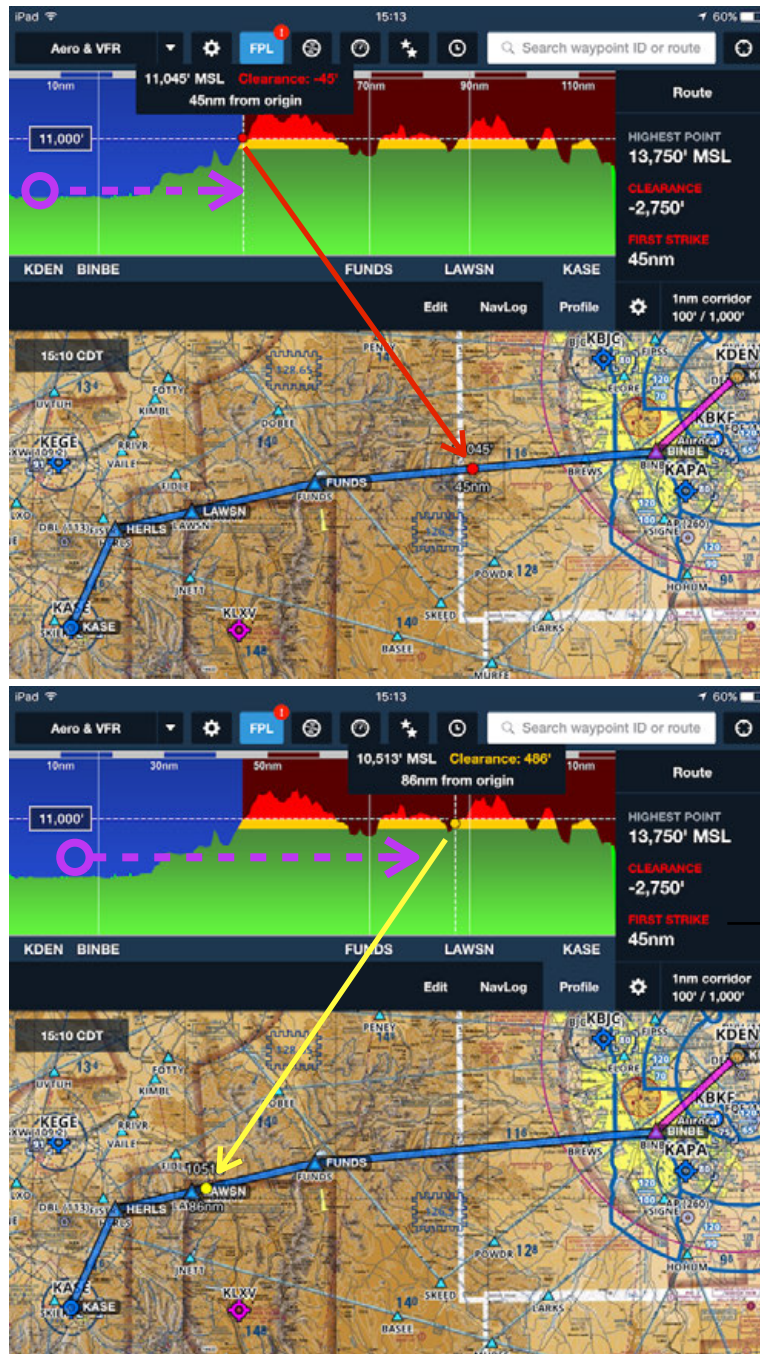

Ruler

When you touch two fingers to the Maps page to display the ruler, the Profile view changes to display the Obstacles and Terrain information under the ruler. You can also “scrub” along the Profile view to see the altitude and clearance pop-up for the area corresponding to points along the ruler’s path.

Single-tap on the Maps page to remove the ruler and return to the Route/Flight Profile view.

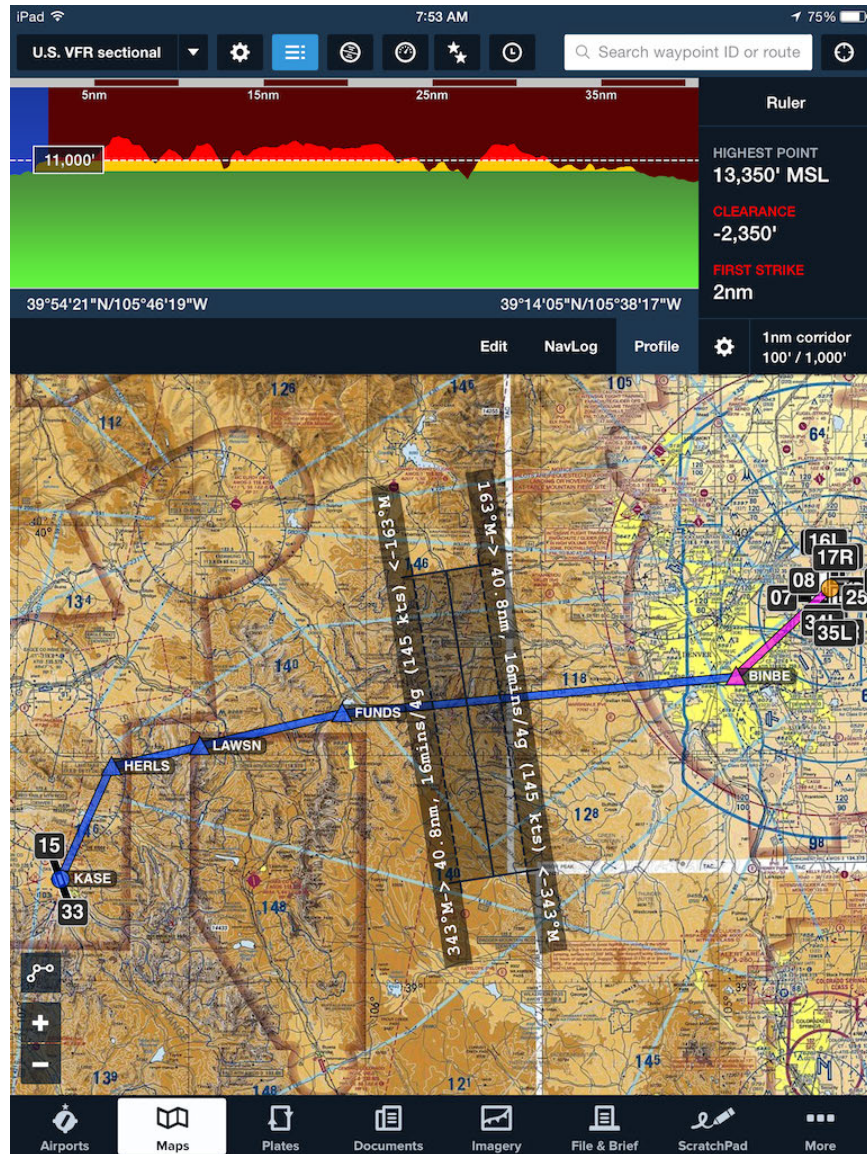

Aircraft view in flight

In flight, the Profile view automatically changes to “Aircraft” mode, which shows obstacles and terrain 50nm ahead of your present location. Pinch-zoom the Profile view to view less than 50nm ahead. Also in Aircraft Mode, your GPS altitude (MSL and AGL) are displayed to the left of the aircraft icon. Tap the “Route” button to show your planned route at your planned altitude in the Profile view. Tap the “Aircraft” button to return to the aircraft view mode.

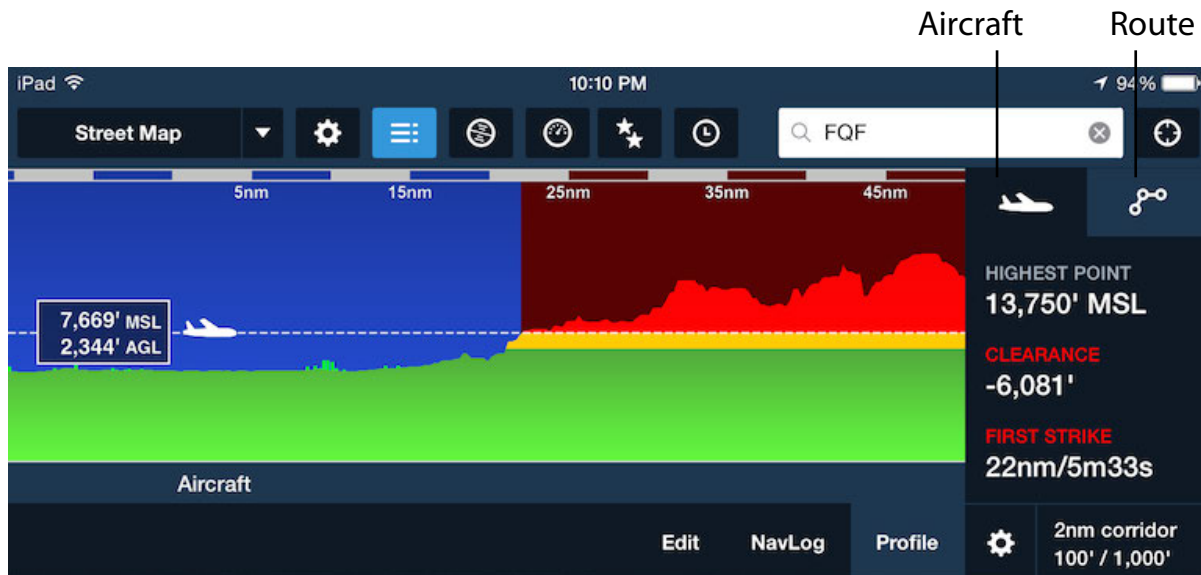

Single-waypoint Search

To find out about another waypoint, airport or navaid that is not on the active route in the Route Editor, simply enter the waypoint, airport or navaid into the Search box. The route will remain active, but the searched-for item will be highlighted on the screen. You can explore that waypoint (such as viewing an airport’s details in a popover view) without affecting the active route, and you can also add it to the route as you would any other location on the map.

Engaging the Moving Map

When the aircraft is not in motion, the current location is shown as a blue dot. When the aircraft is in motion, the current location is shown as an aircraft, which is selected in the **More > Settings** view. If the aircraft doesn't show up on the Map, please review the GPS troubleshooting tips on our web site at www.foreflight.com/support/gps

The map can be set to automatically scroll to keep the current location on the screen. Activate this auto-centering mode by tapping the crosshair button in the top right of the screen, in the gray toolbar. The button turns blue when auto-centering is engaged.

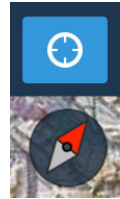

Track Up



Auto-centering can be set to operate in Track Up mode (the top of the screen is rotated to your current GPS track direction), Track Up Forward mode (Track Up mode with the aircraft moved slightly down the screen) and North Up mode. Change modes by tapping the "configure" button with the gear icon in the Maps toolbar. You can also quickly toggle between North Up and your last Track Up mode by tapping the circular "orientation" button just under the auto-center button.

NOTE: If Track-up is selected while stationary, the map will not rotate. Once the aircraft starts moving, the map will rotate so the direction of travel is at the top of the map.

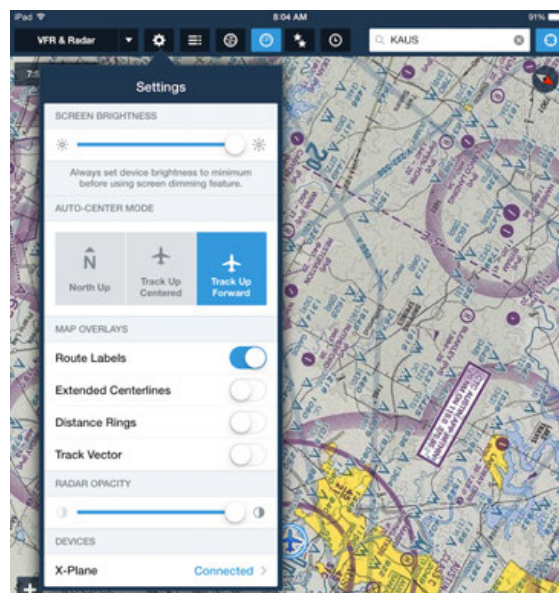
Tap the gear icon in the Maps toolbar to display Settings, then choose Auto-center Mode:
North Up
Track Up Centered
Track Up Forward



Tap the crosshair button to engage Track Up

Tap the orientation button to toggle between Track Up:  and North Up: 

Tap the crosshair button again or manually pan or zoom the map to disable the auto-centering mode. If you pan the map while in track-up mode the current map rotation will be maintained until you tap the auto-center or orientation button in the upper right of the Maps view.

You can prevent the automatic disabling of auto-center mode when panning by changing the Auto Center Deactivate mode in Settings. When that is set to Manual, you cannot pan the map when auto-center mode is ON. Tap the crosshair button to turn auto-center mode OFF so you can pan the map.

Note that only the iPad Cellular model contains a GPS receiver. The Wi-Fi-only iPad does not contain a GPS receiver. In order to use the mobile map functionality with a Wi-Fi-only iPad, you must use a Stratus ADS-B + GPS receiver or an external GPS receiver (see: www.foreflight.com/support/gps).

Distance Rings

Distance Rings displays 3 concentric rings with markers around your aircraft's current position, so you can quickly judge the distance or time from your location to other locations on the chart.

The small green triangles on the rings align with your track and the ring scale labels (either nm or time) align with your right wing.

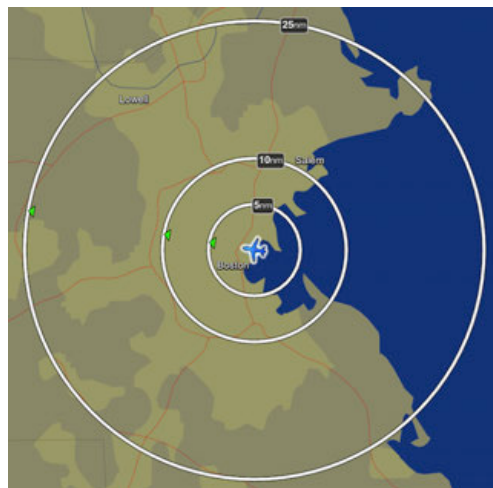

To display the Distance Rings, tap the Map Settings “gear” button to display the drop-down menu, then slide the Distance Rings switch ON or OFF, or change the setting in **More > Settings**.

As you zoom out on the Map the inner rings and scale markers automatically hide to de-clutter the view.

The 3 concentric Distance Rings can be displayed in several styles, selected in **More > Settings**.

Automatic	Distance	Time
NM, ring scales adjust automatically as the map is zoomed in and out	5, 10, 15 NM	5, 10, 30 minutes
	10, 20, 50 NM	10, 20, 60 minutes
	20, 40, 100 NM	

If an Automatic or Distance-based measurement is selected, the rings are only displayed if you have a GPS fix. If a Time-based measurement is selected, the rings are only displayed when you have a GPS fix AND are moving at more than ~10 knots. The rings are hidden when there is no GPS fix, or when moving at less than ~10 knots when a Time-based measurement selected.

Glide Advisor™

The Glide Advisor uses your aircraft's glide ratio, current GPS altitude AGL, surrounding terrain height, and winds aloft (either Packed before your flight, or updated in-flight via ADS-B or SiriusXM) to present a continually-updated ring showing your glide range. **IMPORTANT:** Prior to use, Glide Advisor must be configured with your aircraft's best glide speed and glide ratio (see below).

The Glide Advisor ring shows when your GPS altitude is more than 200' AGL. When the Glide Advisor ring is displayed, the parameters are shown in the lower-right corner of the Maps page. If you have entered glide information for each aircraft (see below), the N-number of the selected aircraft is also shown for quick verification that the correct parameters are being used.

Glide: 70KIAS, 8.0:1

Glide: 70KIAS, 7.9:1 (N101FF)

In the examples below note the difference between the Glide Advisor ring shape in relatively flat terrain, vs. rising terrain, where the ring shape appears irregular due to the height of the surrounding terrain. In these examples the ring is not centered on the aircraft's position due to the effect of winds.

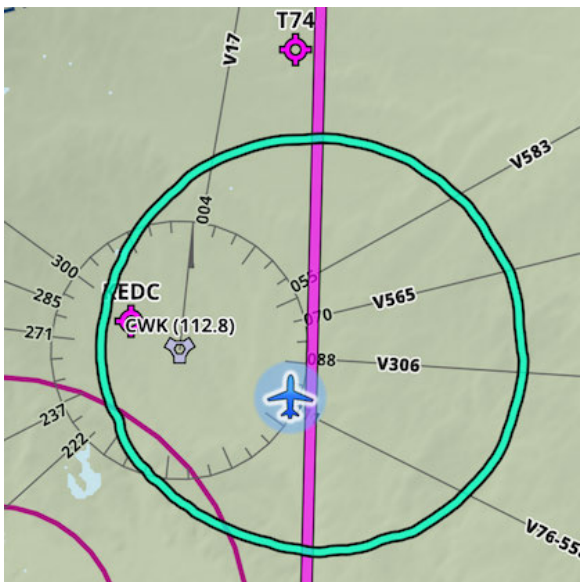

At 6,500' AGL, flat terrain ahead.

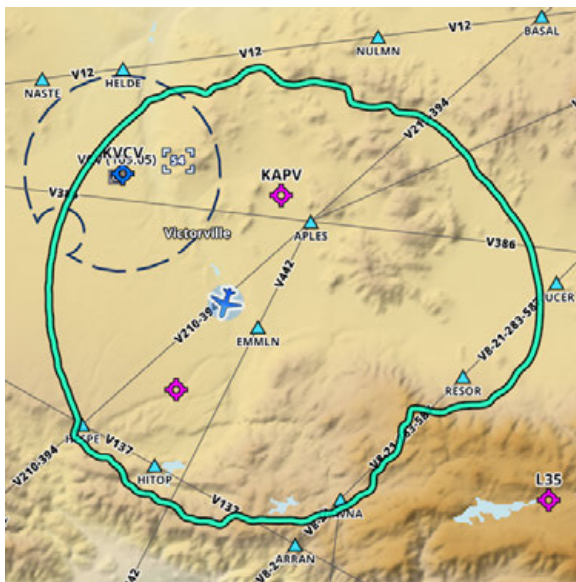

At 12,500' AGL, rising terrain ahead

Before using the Glide Advisor, you must enter the best glide speed and best glide ratio for the aircraft you are flying. It is recommended that you take a few minutes to look-up and enter this information for each of the aircraft you fly so that you can display a correct Glide Advisor ring. Best glide speed and glide ratio information can

be found in your aircraft's POH. You can enter this information in [More > Aircraft](#), or you can enter it on the Maps page in the Maps Settings menu:

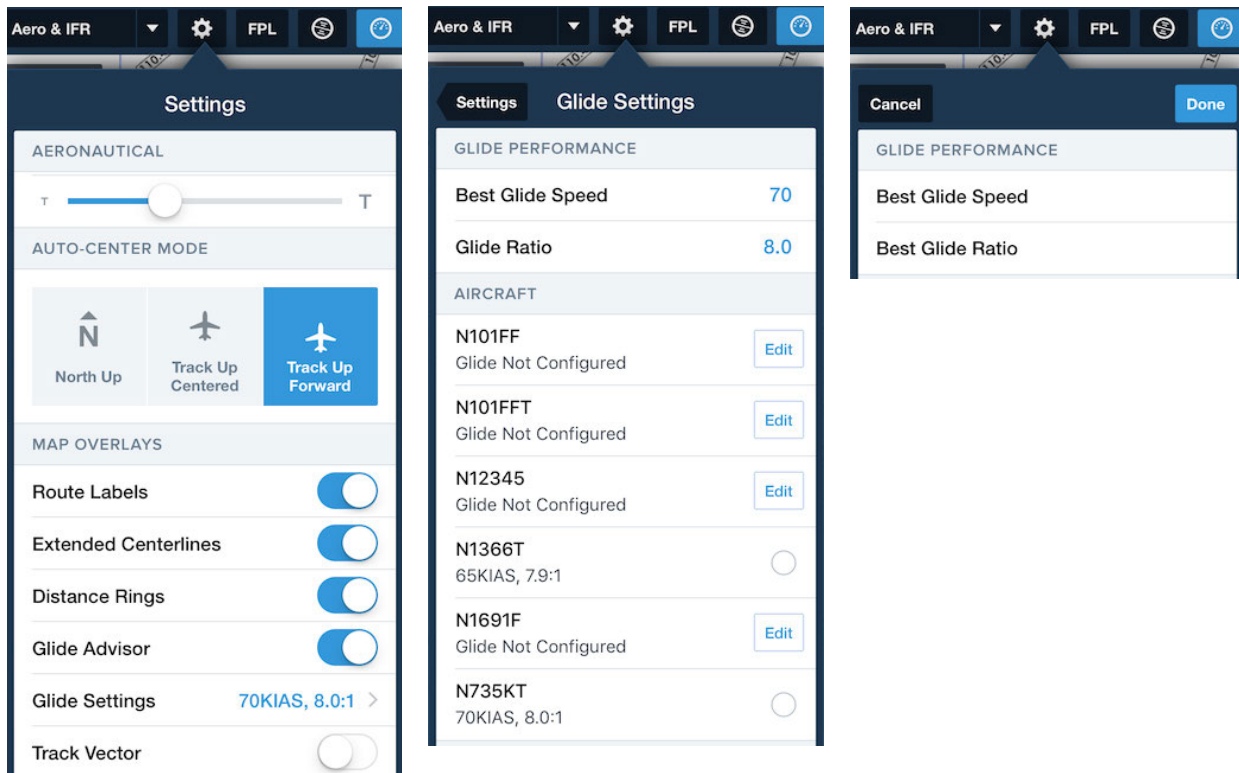

Glide Advisor requires that your aircraft's glide ratio be entered in a form like "8.0:1", meaning that you can glide 8 feet forward for each vertical foot lost - in this case you can simply enter "8.0" in the glide ratio field. However, many POHs express glide ratio in a form like "1.3 nautical miles per 1000 feet", so to get the glide ratio into the proper form you would need to multiply 1.3 by the number of feet in a nautical mile (6,076.12) and divide by 1000. Most glide ratios for powered, fixed-wing aircraft (excluding gliders) fall somewhere between 5 and 15, so if your glide ratio appears to be much smaller or larger than this, double-check your math.

Track Vector

When the Track Vector is ON, a projected track is displayed in front of the aircraft icon. The length of the vector is controlled by the setting on the More page under Settings, and can be 15, 30, 45, 60 seconds; 2, 5, 10 minutes or 1/2, 1, 2, 5, 10, 25, 50 Nautical Miles.

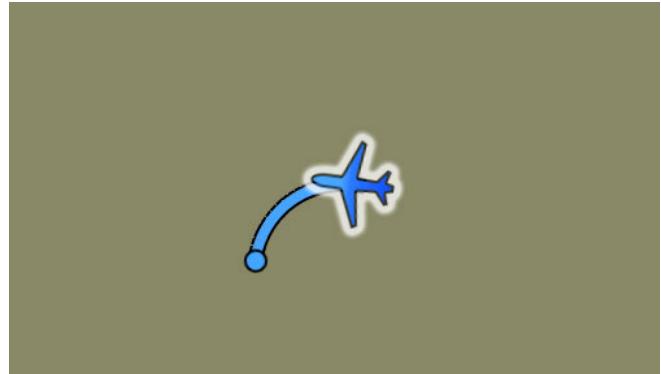
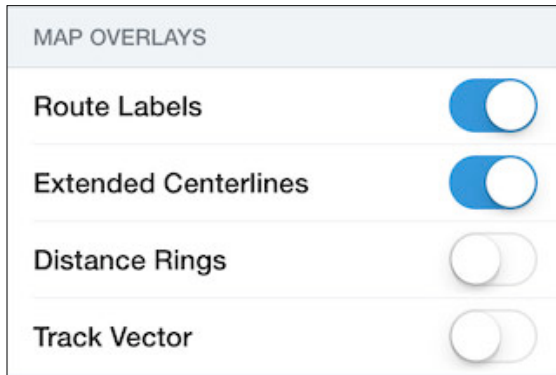

While your track direction is changing at more than 2 degrees-per-second (i.e., the aircraft is turning) the track vector changes to a curve in the direction of your turn.

Direct-To

To create a direct-to change to your route, tap a waypoint on the route. Then tap the orange **Direct To** button. An alternate method is to tap the arrow icon  in the NavLog, or to tap the colored oval in the Route Editor and choose **Direct To**.

Choosing **Direct To** removes all waypoints in the route prior to the selected waypoint and adds a new direct-to leg from present position to the selected waypoint.

Additionally, a direct-to change can be made to utilize a waypoint not already in the route. See the "Touch Planning" section for details.

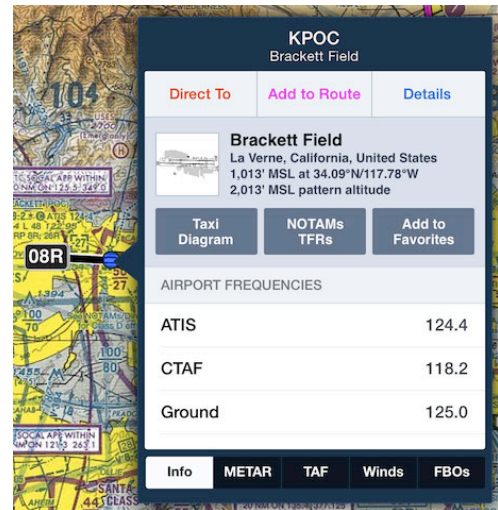

Ruler

Distances can be measured on the Maps view at any time by holding down two fingers on the map until the ruler appears. Hold both fingers on the Map and slide them across the map to reposition the ruler to take measurements between other locations. The ruler is also handy for quickly visualizing great-circle (direct) routes between two points. When measuring distances less than three nautical miles the distance will also be displayed in feet, helpful for measuring available runway.

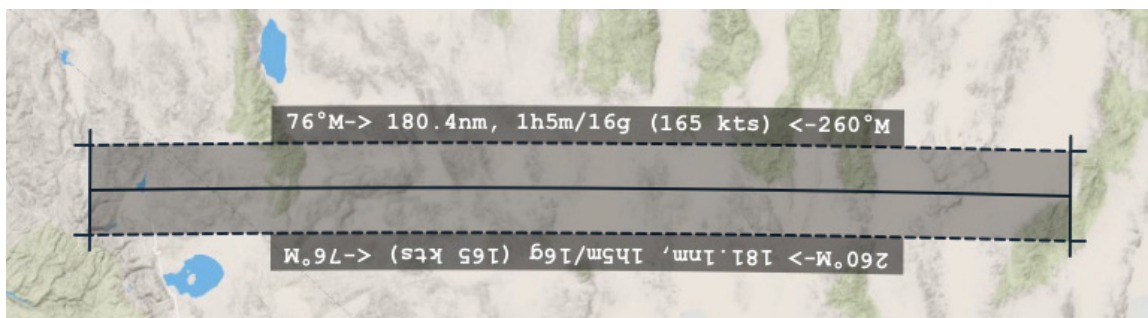

When using the ruler in flight, the current groundspeed will be used to show the time of travel for the distance measured. When not in flight, the TAS from your current route or default aircraft will be used instead.

Fuel burn estimates are also shown using the fuel burn provided for the current route or from the default aircraft. All time and fuel estimates are based on no-wind conditions. Initial course bearings are also shown from each side of the ruler.

The ruler will remain on the Map after you remove your fingers. To remove the ruler, tap on the Map.

Viewing and Hiding the Instrument Panel

To show or hide the Instrument Panel, tap the “instrument” button.



When a position fix is available, the instruments in the Instrument Panel at the bottom of the map update to reflect the latest values for groundspeed, track, and geometric MSL altitude. Additionally, an accuracy value is provided as an indication of the quality of the fix (lower numbers are better).

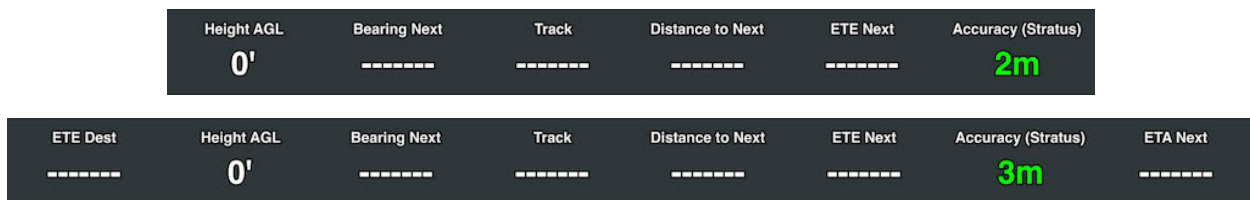

On the iPad, 6 instruments are displayed in the Instrument Panel in portrait orientation and 8 in landscape orientation. On the iPhone, 4 instruments are displayed in portrait and 6 in landscape.

The instruments on the right and left ends of the Instrument Panel in Landscape mode are hidden when the device is rotated to Portrait. The default instruments displayed in the Instrument Panel can be replaced with an instrument of your choice by tapping an instrument and selecting a new one from the pop-up list.

The *Select Instrument* pop-up displays all available instruments. Be sure to scroll the list up/down to see each instrument. The list provides a description of each instrument’s function, as well as an indication of which ones are already displayed. **NOTE:** When in Portrait orientation, the 2 additional instruments visible in Landscape are shown as

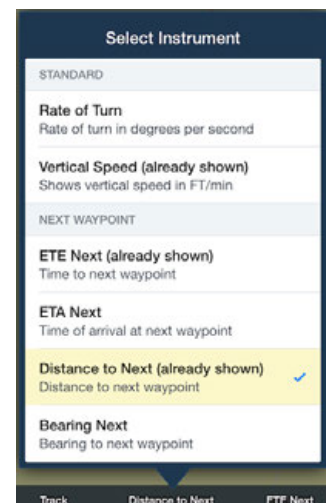

being “(already shown)” even though they are not visible on the screen.

The following instruments are available in the Instrument Panel:

Standard	Next Waypoint	Destination	Other
Groundspeed	ETE Next	ETE Dest	Current Lat/Lon
GPS Altitude	ETA Next	ETA Dest	Zulu Time
Pressure Altitude	Distance to Next	Distance to Dest	Blank
Cabin Pressure	Bearing Next	Bearing to Dest	Flight Time
Height AGL #	Course Next	Descent to Dest	
Height MEF #	Cross Track Error		
Track	Nearest Airport		
Accuracy	Nearest Navaid		
Rate of Turn			
Vertical Speed			
Climb Gradient			

Pressure Altitude and **Cabin Pressure** show pressure altitude as derived by a barometric sensor, if present. If the sensor is in your iPad or iPhone, only Cabin Pressure will display a value. If connected to a Stratus or other external device with a built-in barometric sensor, both instruments will show the same value and Pressure Altitude will have an “Uncorrected” label, indicating that the value may not correspond to actual indicated altitude. However, if the “Pressurized Cabin” switch is enabled in the connected device’s settings then only the Cabin Pressure instrument will display a value; the Pressure Altitude instrument will be blank. If connected to a Satcom Direct router or other installed avionics that can provide actual indicated altitude, the Pressure Altitude instrument will display a value with a “Corrected” label (Performance Plus or Business Performance subscription required).

Height AGL shows the GPS altitude above the highest terrain within a 1/4 nm circle around your present location. #: iPad only; Pro, Pro Plus, or Performance Plus subscription required.

Height MEF shows a dynamic Maximum Elevation Figure for a 1/2 degree latitude by 1/2 degree longitude box centered on your aircraft’s location. MEF is calculated

as: the tallest obstacle or terrain in that box, rounded up to the nearest 200 feet. #: iPad only; Pro, Pro Plus, or Performance Plus subscription required.

Nearest Airport shows the Cardinal position and distance from the nearest airport to your present location.

Nearest Navaid shows the Navaid identifier and the radial and distance from that Navaid.

Flight Time shows the total flight time while recording a Track Log. See [Flight Time Instrument](#) for more information.

Using Favorite Routes

To view a favorite route, tap the double-star button in the dark blue tool bar at the top of the Maps view. A list of your favorite routes is displayed.



Tap a route in the list to make it the current route.

To delete a route from the favorites list, use swipe-to-delete on the route.

The favorites list can be re-ordered by tapping the **Edit** button. Once in *Edit* mode a three-bar icon is displayed on the right of each route in the list. Tap-and-hold on the three bar icon until the row appears to lift up, then drag the row to the desired location in the list. You can also delete the route by tapping the red button on the left.

Note that removing routes from your *Favorites* list will not affect items displayed in the *File and Brief* view.

Using Recent Routes

Every route shown on the Map is automatically saved to the Recent routes list. This provides a great way to quickly jump to a previously viewed routing or performance configuration.



View this list by tapping the clock icon in the dark blue tool bar at the top of the view. Tap a route in the list to make it the active route.

Delete a route from the recents list using swipe-to-delete, or delete all routes from the recents list by tapping the **Clear** button at the top of the list.

Favorite and Recent Route Sync

Changes to your Favorite and Recent routes, including adding, removing and change the order of the routes, are automatically synchronized to each device that is

signed-in to your ForeFlight Mobile account. For more information, see the [Sync chapter](#).

Clearing a Route

Clear a route from the Map by tapping the “Clear” button in the Route Editor. Tap the Flight Plan Editor “FPL” button (bright blue in top-middle of this screenshot) to show the Route Editor:

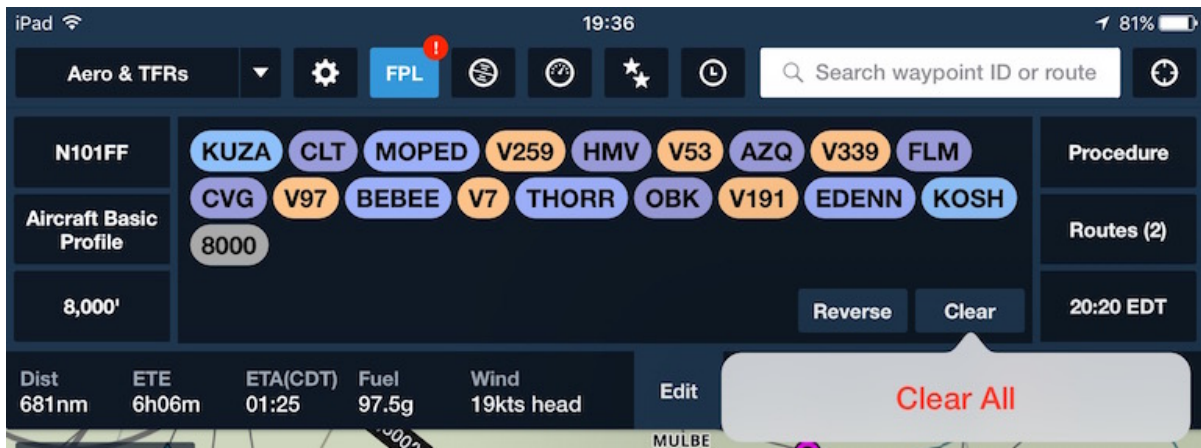

Alerts

About The Design

ForeFlight Mobile provides a number of in-app audio and visual alerts that help to keep pilots aware of potential hazards and improve situational awareness in flight and on the ground. Alerts appear in red or beige rectangles in the upper third of the screen and persist for several seconds; they can be dismissed more quickly by tapping on them. Audio alerts can be silenced, and individual alerts disabled entirely in **More > Settings > Alerts**.

Runway Proximity Advisor

ForeFlight Mobile has a visual and audio alert system that triggers when you taxi near or onto a runway. This system uses GPS and geographic runway safety areas to alert pilots as they approach or enter a runway environment. This feature is available for all ForeFlight subscriptions.

The system runs automatically in the background, regardless of which part of the app is currently visible. ForeFlight Mobile must be running and visible on the iPad screen for the system to function. Essentially all airports in the USA are supported.

As you near the runway the system will provide an "Approaching" alert which includes the name of the runway. Upon entering the runway itself, the system will provide an "Entered" alert, which includes both the name of the runway and the length of runway remaining in feet, rounded to the nearest hundred. If the aircraft is not clearly at one particular end of the runway, the system will alert with both runway end names and will not include a length remaining upon entering the runway. For instance, it will say "02-20" instead of just "02."

To receive audio alerts in your headset, use a bluetooth-capable headset and connect it to the iPad. Ensure that the iPad

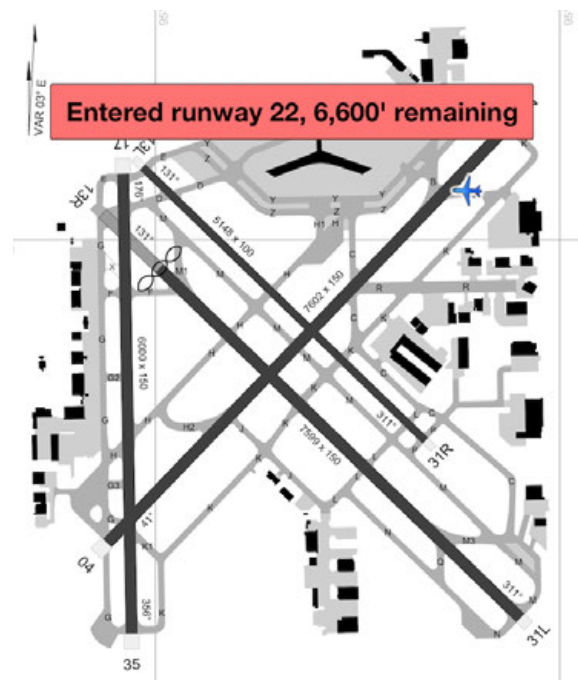

volume is set to an appropriate and safe level.

If you are using a vibration-capable device, like the iPhone, the device will vibrate when audio alerts are given.

Alerts are automatically disabled when the aircraft is stopped or traveling faster than 40kts. Note that you may receive an alert on take-off if you cross a different runway early in the take-off roll. Similarly, on landing you may receive an alert if you cross another runway while rolling out. You will not be alerted about entering your landing runway when landing - you have to *taxi* onto or near a runway to get an alert.

Cabin Altitude Advisor

If your iPad/iPhone is equipped with a barometric pressure sensor, or is connected to an external device that provides that capability (such as a Stratus 2S or Garmin Flight Stream 210), ForeFlight will monitor your cabin's pressure altitude and provide alerts when you pass 12,000' MSL and 25,000' MSL.

Caution, cabin altitude above 12,000'

Alert, cabin altitude above 25,000'

Each alert will not sound more than once every 30 minutes.

Traffic Alerts

When connected to an external device that provides ADS-B traffic data (such as a Stratus 2S), ForeFlight can issue alerts when another aircraft passes within 1.8NM horizontally and +/- 1,200' vertically of your aircraft's position. See [Traffic Alerts](#) for more information.

TFR Alerts

TFR Alerts monitor your GPS position and track for nearby known TFRs and provide visual and/or audio alerts to warn you if your present track will take you inside (or over/under) a known TFR within the next 5 minutes, even if you don't have the TFR map layer turned on. Four different alerts are possible based on your position relative to the TFR: "TFR Ahead", "TFR Below", "TFR Above", and "Inside TFR."

If ForeFlight detects that you will enter or pass within three nautical miles of an active (or soon-to-be active) TFR within the next five minutes it will issue a “TFR Ahead” alert, or “Upcoming TFR Ahead” if the TFR is not yet active. A TFR’s altitude (MSL or AGL) is taken into account when determining if you will enter it, and an adjustable altitude buffer is provided in **More > Settings > Alerts** so you can customize how close your altitude must be to the TFR for the alert to activate.

The altitude buffer has settings for 500’, 1000’, 2000’, and 5000’. If you are outside a TFR’s altitude but within the selected buffer altitude, ForeFlight will issue “TFR Below” or “TFR Above” alerts as you pass respectively above or below the TFR. If you enter a TFR within its altitude range ForeFlight will issue an “Inside TFR” alert.

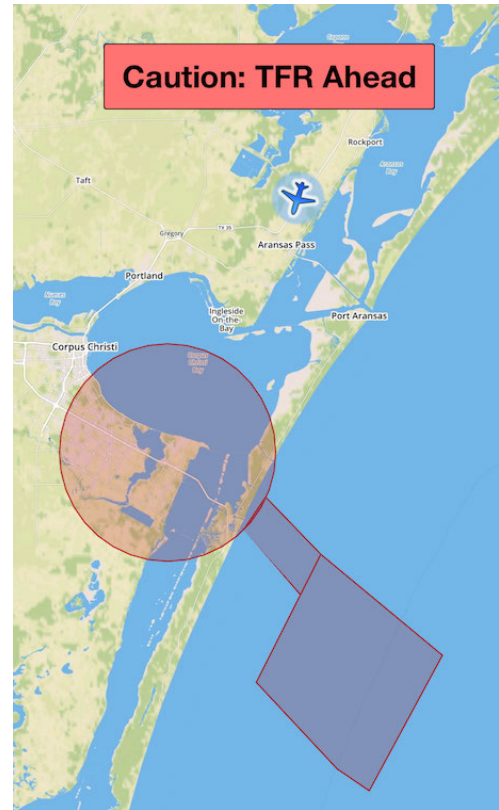

TFR ALERTS IMPORTANT NOTICE:

TFR alerts are provided **only** as a tool to increase situational awareness in flight. They **do not** replace conventional tools and practices for avoiding TFRs and should not be used as such.

ForeFlight can only provide alerts for TFRs that it has information for, which requires you to download that information before flying. Failing to do so may prevent ForeFlight from displaying alerts for active or soon-to-be-active TFRs.

Immediately before your flight: While still connected to the Internet, use the [Pack](#) feature to ensure all relevant TFR and weather data is downloaded. Alerts for TFRs issued **after** you Pack will not be shown, unless you are using an ADS-B or XM in-flight weather receiver.

Sink Rate

The Sink Rate alert warns you when your downward vertical speed exceeds a certain amount, which varies based on your height above ground so as to warn you sooner at lower altitudes.

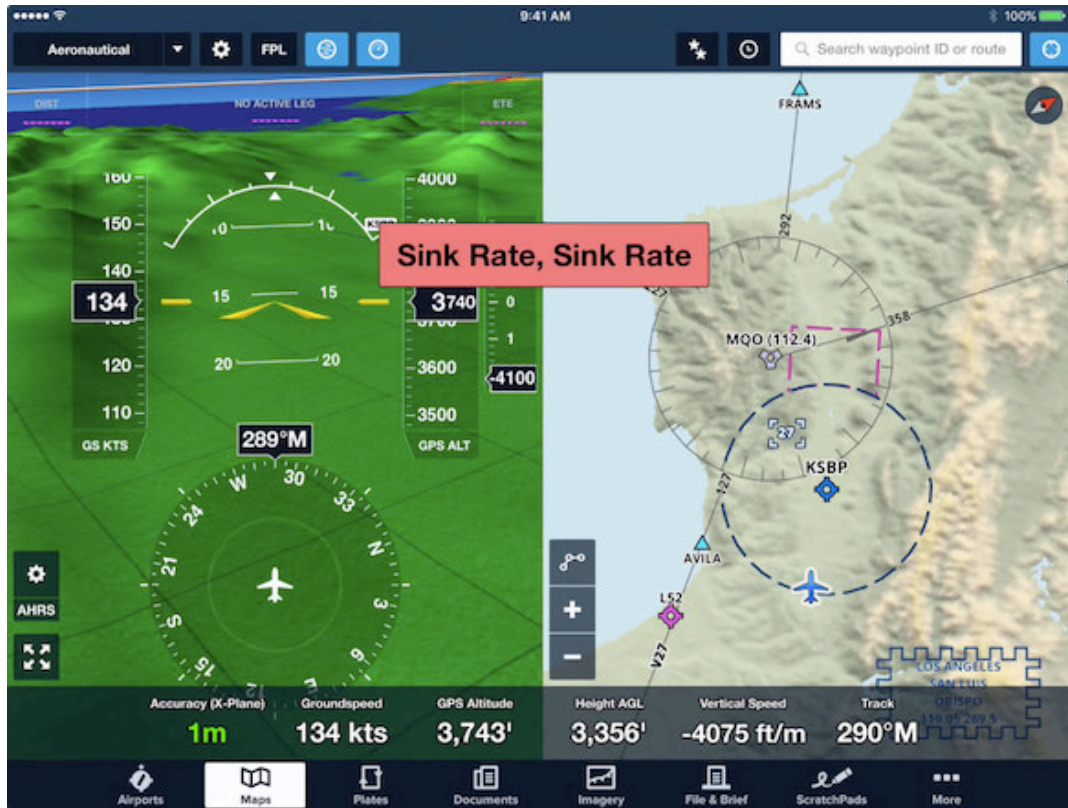

At all altitudes, the descent rate required to trigger the alert must be maintained for five seconds, and the alert will only sound once every 30 seconds. This alert is automatically disabled if your groundspeed is less than 40kts.

Above 2,500' AGL (or when AGL is not known), the alert is triggered if your descent rate exceeds -4,000' per minute.

At 2,500' AGL, the alert is triggered if your descent rate exceeds -3,000' per minute.

Between 2,500' AGL and 500' AGL the descent rate required to trigger the alert decreases linearly along with altitude, down to a threshold of -1,500' per minute.

At 500' AGL the alert is triggered if your descent rate exceeds -1,500' per minute.

500' AGL

The 500' AGL alert is a simple callout that triggers when you descend through 500' AGL after having been above 1,000' AGL. The alert will only sound once every 60 seconds, and is automatically disabled if your groundspeed is less than 40kts.



Device Disconnect

The Device Disconnect alert is triggered if the Bluetooth or Wi-Fi connection to a portable or panel-mounted device that ForeFlight supports is lost. This allows you to take appropriate action to restore the connection, to switch to a backup device (if available), or to continue the flight knowing that the previously connected device is no longer available. The alert is only triggered if your groundspeed is above 40 knots or if your device does not have a GPS fix.



Destination Weather Frequency

The destination weather frequency callout provides you with your destination airport's weather frequency (whether ATIS, AWOS, or ASOS) as you near the airport.

The callout requires that the last item in your route be an airport (there must be more than one item in your route) and that the airport has a weather frequency. The callout occurs at a certain distance from the airport, which is greater at higher altitudes - at 5,000 feet or below the callout occurs at 20nm from the airport.

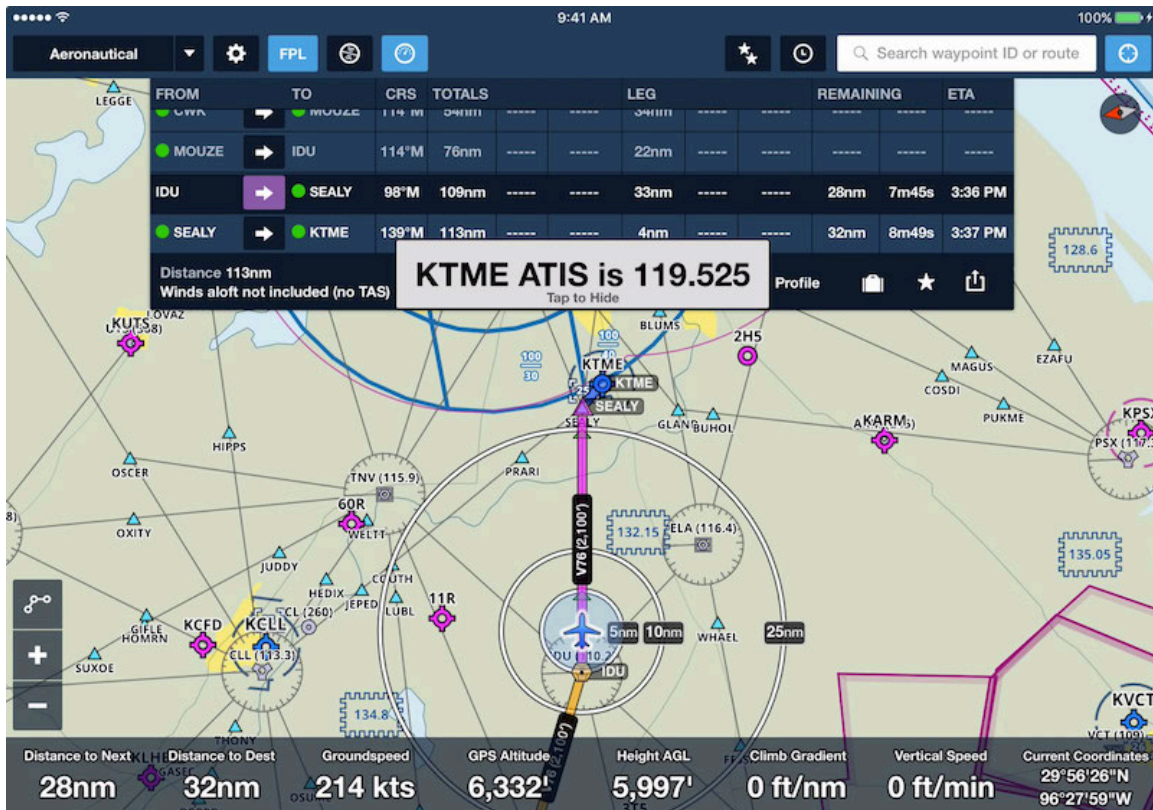

Unlike other alerts, the weather frequency popup does not disappear after a few seconds - it will remain on the screen until you dismiss it by tapping on it.

The callout will not occur more than once every 20 minutes for the same airport, but if you change the destination airport then the callout can occur again in less time for the new airport.

New Flight Plan Loaded From Panel

If connected to installed avionics that can send flight plans to ForeFlight (such as Garmin Connex devices), and “Auto-Receive Panel Flight Plans” is enabled in More > Settings, any time ForeFlight receives and loads a new flight plan from the panel it will display a “New Flight Plan Loaded From Panel” message.



New Flight Plan Loaded From Panel

Pack

About the Design

While connected to the Internet, use Pack to supplement your [Downloads](#) by running a preflight check to ensure you have the information you need for a trip downloaded to your device for offline (inflight) use.

Packed data is not saved somewhere different than you're used to, but is seamlessly integrated with the rest of the data you already have downloaded or are viewing over the Internet. You view the Packed charts, plates, and data as you are used to doing: on the Maps page, Plates page, Airports page, etc...

Charts and plates downloaded using Pack are for the current data cycle only and will not automatically update at the next data cycle.

Pack analyzes the route in your Flight Plan (or Routes page on the iPhone) by looking at a corridor 50 NM wide (25 NM on each side of your route) and 100 NM in diameter around your departure and destination. Pack will download charts and plates for any states that fall inside the boundary. In the example below the route from KMIC to KCID runs from Minnesota to Iowa but the borders of Wisconsin and Illinois both fall inside the Pack boundary. So charts and plates for WI and IL will also be selected for download when using Pack for this route.

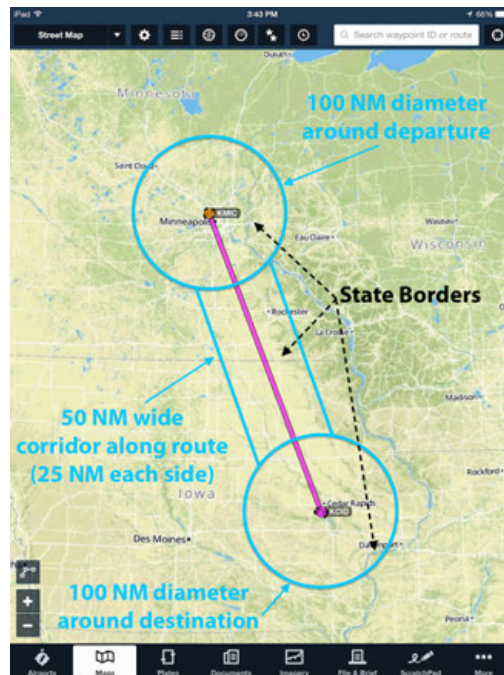

IMPORTANT: Pack only analyzes the charts along your route based on the chart type selections you made in the [Download Settings](#) view. So for example if you are planning a flight above 18,000' be sure you have IFR High Charts turned ON.

Pack also downloads any Weather (METAR, TAF and MOS), AIR/SIGMETs, TFRs and fuel price data inside the 50 NM route corridor and 100 NM diameters departure/destination circles.

If you have a Pro Plus, Performance Plus, or Business Performance subscription plan, Pack will download forecast data for the [Icing](#), [Turbulence](#), and [Surface Analysis](#) layers. If your route of flight stays within the bounds of the U.S.-only layers for icing and turbulence, Pack will only download data for those layers. If your route of flight stays entirely outside the bounds of the U.S.-only layers, Pack will only download data for the Global layers. If your route of flight crosses the boundary, Pack will download data for both the U.S. and Global icing and turbulence layers.

Pack will automatically analyze your route if the Pack "Enable Auto Check" is ON in More > Settings. If it is OFF, Pack will analyze your route only when you tap the Pack button at the bottom right of the Flight Plan Editor: 

If Enable Auto Check is ON, Pack periodically re-analyzes the route and will alert you if new items become available. Once you Pack for the trip METAR, TAF and TFR updates will be downloaded automatically, provided the route has not been changed.

Even with Pack, it is a recommended best practice to check that the desired areas have been selected on the [Downloads page](#). This will speed up packing since fewer charts and plates will need to be downloaded when using Pack before a flight.

If your route includes states you have not selected to download in More > Downloads > United States, Pack will download that state's data but the state will not be selected for ongoing downloads (in future data cycles) in More > Downloads > United States. This means that when the next data cycle goes live, the states that were Packed will show as Expired. Clear the message by tapping More > Downloads > Delete > Delete Expired.

Tip: Pack for your flight (see below) once you've finished planning your route to ensure you have the data needed for your flight and so you have time to review relevant TAFs, METARs, NOTAMs, TFRs, etc. Shortly before you head to the plane for the flight, use Pack one more time to make sure you have the latest available data.

IMPORTANT: While Pack is downloading, **DO NOT** start or cancel downloads on the [Downloads page](#).

Pack for a Flight

iPad

After entering a route in the Route Editor, Pack analyzes the route to determine if any data needs to be downloaded. If data does need to be downloaded, a red "!" is displayed on both the Pack (suitcase) button and the FPL hide/show button.

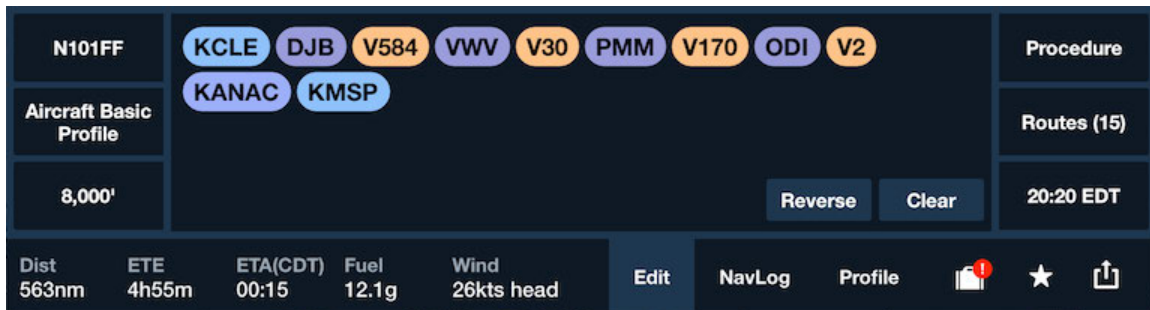

Tap the Pack (suitcase) button at the bottom of the Flight Plan Editor to open the Pack pop-up and review the list of needed downloads. An estimate of the amount of data to be downloaded is shown in the lower left corner.

Tap the blue **Pack** button to download all listed items. If you are short on time and only want to download a few items, instead of tapping the Pack button, tap on the blue download arrow next to each item(s) you want to download. **REMEMBER: information you don't download will not be available in flight.**

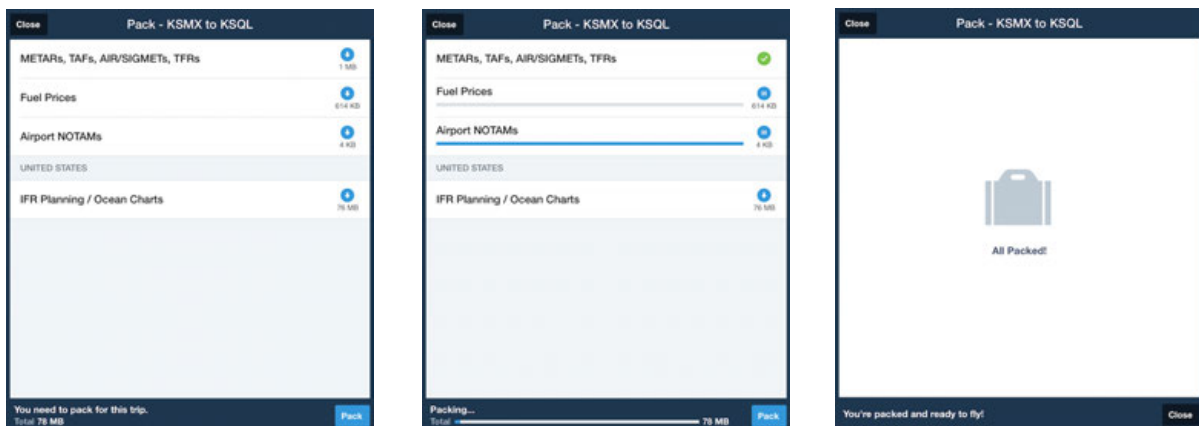

Tap outside the Pack pop-up to close the pop-up and continue using ForeFlight while the Pack data is downloading. Tap the Pack (suitcase) button on the Flight Plan Editor

to open the pop-up to check Pack status. When Pack has finished downloading the ! will disappear.

If the route is changed significantly while Pack is downloading, the Pack downloads will stop automatically and the Pack Alert pop-up will appear.

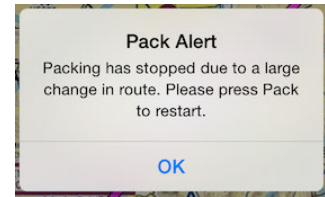

If Pack seems to stop downloading, close the Pack window, return to the Route Editor and make a change to the route (e.g., delete then reinsert a point). This will cause Pack to reset and re-analyze the route.

iPhone

Pack is available on the Route page, which is accessed by tapping on the Menu button, scrolling down to the Routes section and either (1) tapping on any one of the listed routes; (2) tapping on the Favorites or Recents button and selecting a route; or (3) tapping on Create to make a new route.

After choosing or entering a route, scroll to the bottom of the Route page to the Pack line. After a few seconds, Pack will analyze the route to determine if additional items need to be downloaded.

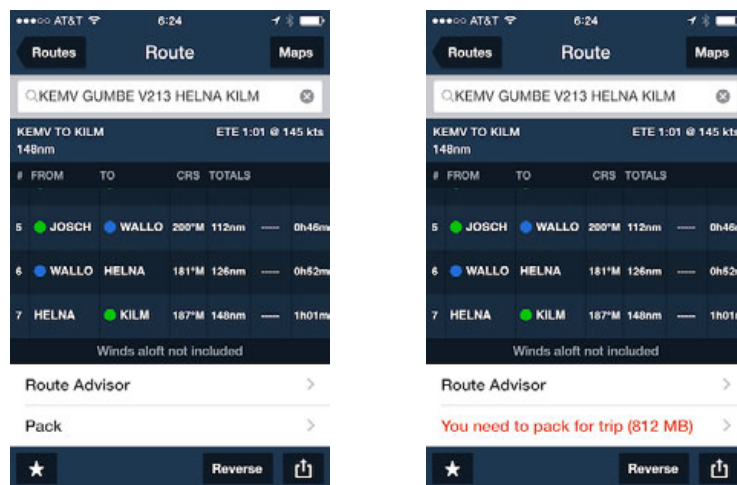

If items are needed for your trip, the "Pack" line will change to, "You need to pack for the trip (## MB/GB)." The ## MB/GB is an estimate of the amount of data to be downloaded.

Tap the "You need to pack for the trip" line to view details of the the items that need to be downloaded. Tap the blue Pack button to download all listed items.

If you are short on time and only want to download a few items, instead of tapping the Pack button, tap on the blue download arrow next to each item(s) you

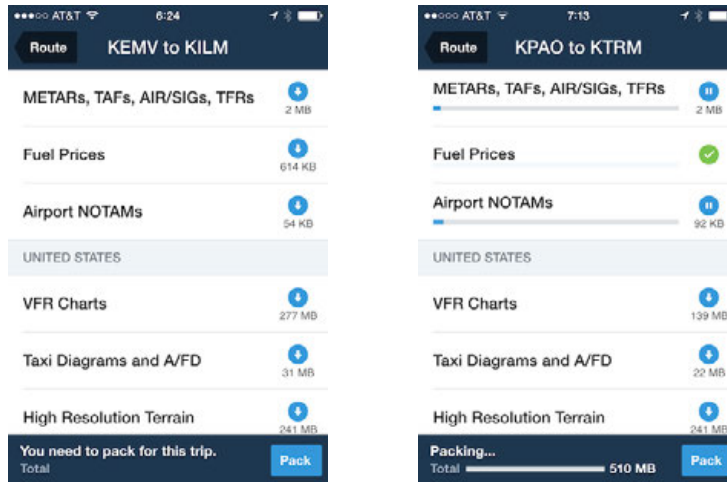

want to download. **REMEMBER: information you don't download will not be available in flight.**

If Pack seems to stop downloading, return to the Routes page and make a change to the route (e.g., delete then reinsert a point). This will cause Pack to reset and re-analyze the route.

Sync

About the Design

Sync is a fast, cloud-based system that works seamlessly in the background to synchronize Recent and Favorite Airports, Routes, Weather Imagery, User Waypoints, Aircraft, ScratchPads (iPads only), Flight Plans (both filed and un-filed), Navlogs, and Weight & Balance profiles between all devices signed-in to your ForeFlight account. Because sync'd information is stored in the cloud, changes made on one device will automatically be delivered to the other device when it is connected to the Internet.

IMPORTANT: Sync is disabled by default for multi-pilot accounts with a shared single login.

Using Sync

Activate Sync on each device in More > Settings by turning **Synchronize User Data** ON. After Sync is turned on, User Waypoints and the Recent and Favorite Airports, Routes, Aircraft, ScratchPads (iPads only), Flight plans from the Flights page, weather Imagery, and Weight & Balance profiles are synchronized to all devices.

If you change the order of items in a Favorites or Recents list on one device, the order of the items in the list will be synchronized to all other devices.

For example, suppose you have an iPad and an iPhone signed-in to your account, and two User Waypoints: WPT1 and WPT2 on your devices:

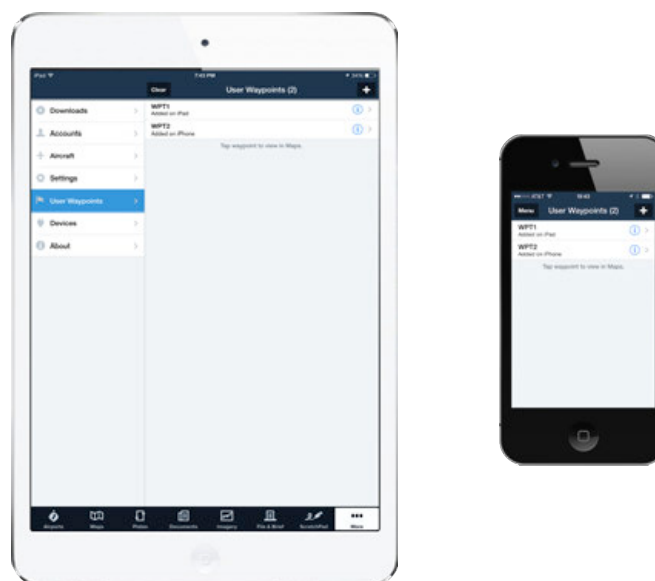

When you add a new User Waypoint WPT3 on the iPad, Sync will add WPT3 to the iPhone via the cloud:

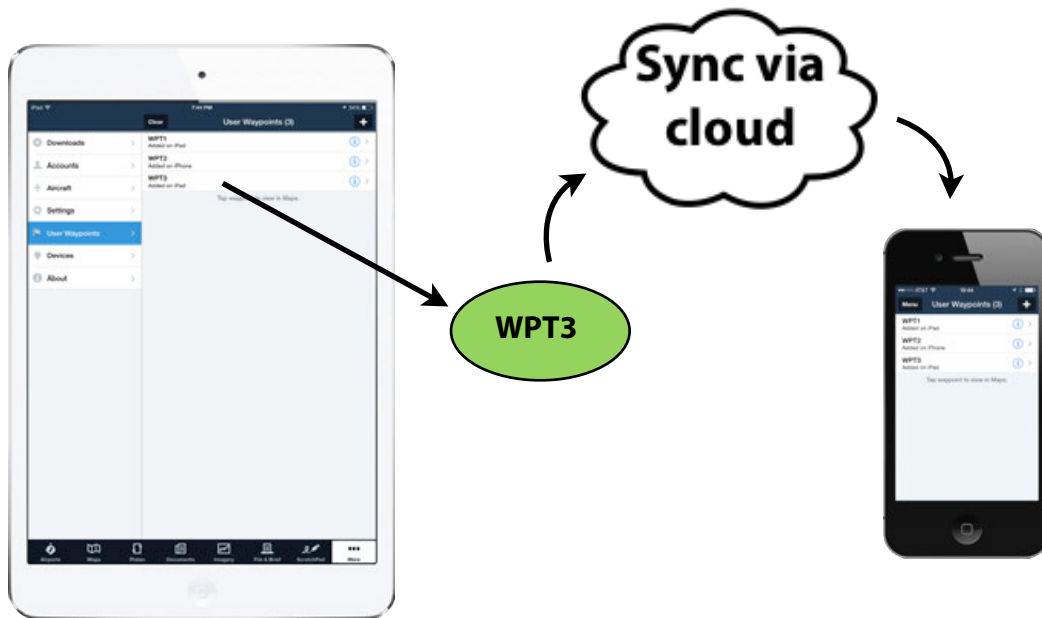

If you make changes on one device while it is not connected to the Internet, the next time that device goes online Sync will send those same changes to the other device(s) via the cloud.

IMPORTANT: If you delete a sync'd data from one device, Sync will also delete it from ALL other devices on which Synchronize User Data is ON. For example, if you delete WPT1 from the iPhone, Sync will delete the waypoint from the iPad via the cloud:

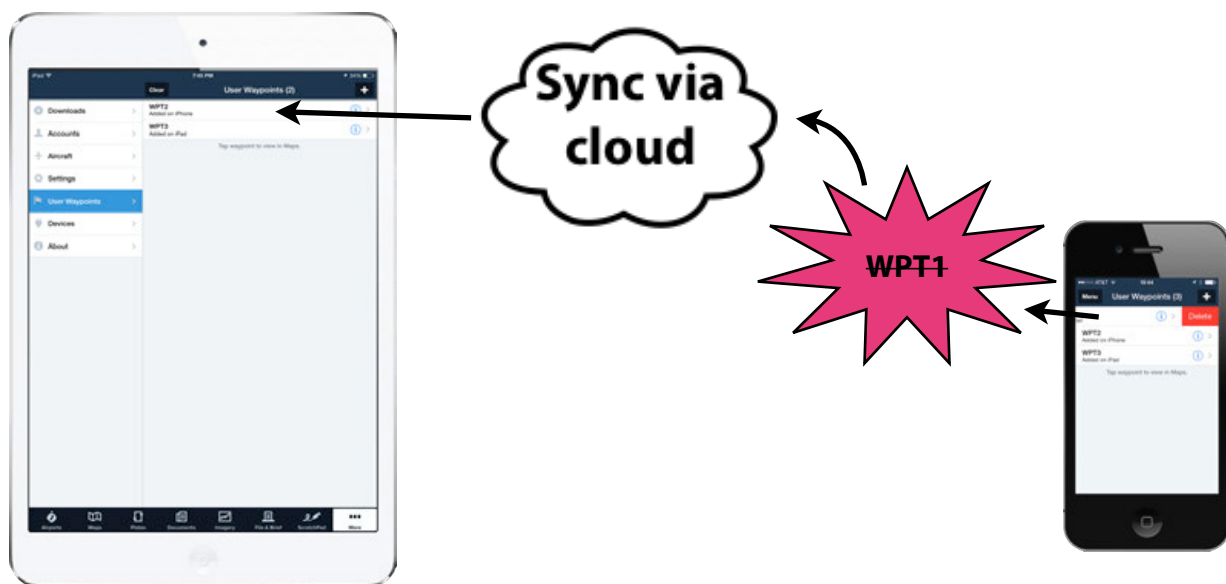

If Synchronize User Data is OFF on one device, as soon as you turn it ON, the item that was deleted from the first device will then be deleted from the other device.

NOTE: If you sign-out of the ForeFlight account on a device, ALL sync'd data is also removed from that device. Then when you sign back in to your account, all sync'd data is restored to that device.

When you install ForeFlight Mobile on a new device, turn **Synchronize User Data** ON to automatically load all of your User Waypoints, Recent and Favorite Routes, Aircraft, Flight Plans from the Flights page, and Weight & Balance profiles into the new device.

NOTE: If a User Waypoint with the same name is manually created on two devices while one or more of the device(s) is offline, or while Synchronize User Data is OFF on one or more of the device(s), then when the devices are online or Synchronize User Data is turned ON, two User Waypoints will be shown with the same name on each device. Resolve this by changing the name of one of the same-named User Waypoints, or by deleting one of the same-named User Waypoints.

Cockpit Sharing

About the Design

Cockpit Sharing allows you to share a route with another device running ForeFlight Mobile, provided both devices are on the same WiFi network: either an Internet-connected WiFi-hotspot on the ground or a WiFi-equipped ADS-B receiver like the Stratus family of portable ADS-B receivers.

Using Cockpit Sharing

Activate Cockpit Sharing on each device by tapping on **More > Settings** and turning "Cockpit Sharing" **ON**.

Send from an iPad: Tap the **Send To** button  on the Flight Plan Editor to see a list of all possible destinations. Tap the desired destination to send the route.

Send from an iPhone or iPod Touch: Choose a Route on the Routes page, then tap the **Send To** button and tap name of the destination device in the list.

On the receiving device, tap **View Route** on the pop-up to load the route, or tap **Cancel** to ignore the route sharing request.

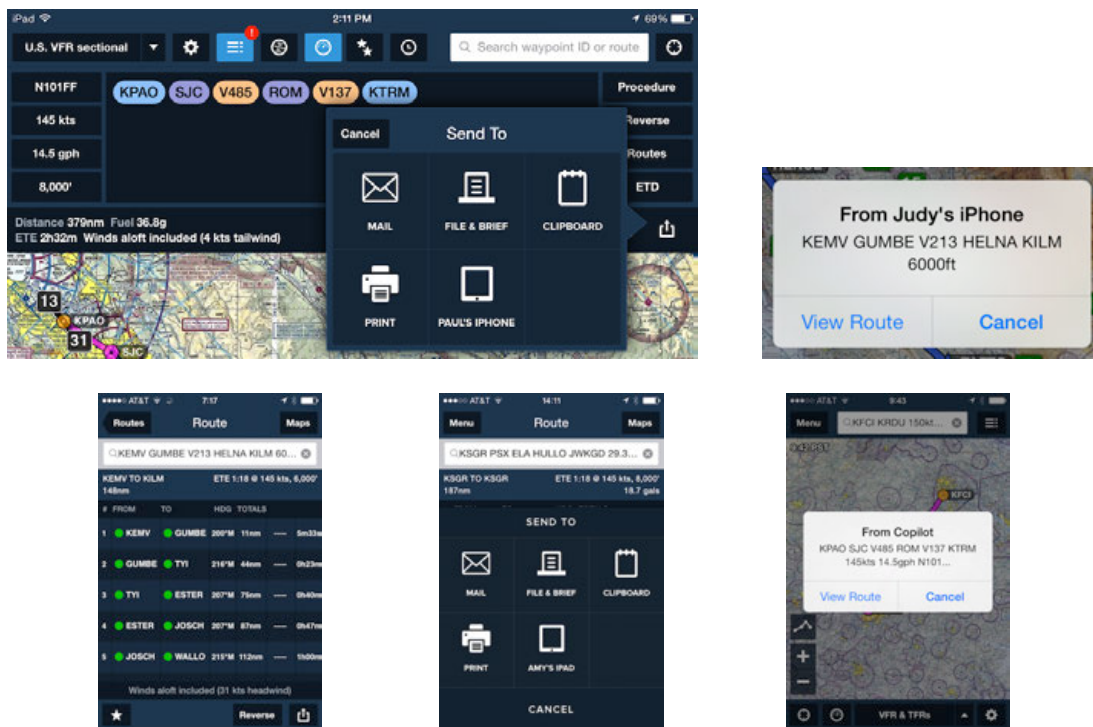

Plates

About the Design

Instrument pilots use their procedures differently in the air than when on the ground. Often, you'll view an arrival, approach, and then taxiway diagram - all without needing to return to a chart or A/FD in between. The *Plates* view is designed to account for the way you use procedures *while* you're flying.

The *Plates* view provides access to approach plates; taxiway diagrams, and arrival and departure procedures. This view enables you to organize the plates in the way that makes the most sense to you and streamlines your access to each procedure.



About Plate Binders

Binders provide a method for organizing plates into logical groups for easy access while in flight. A plate binder can contain any combination of:

- ❖ **Airport Diagrams**
- ❖ **Hot Spots**
- ❖ **Take-Off Minimums**
- ❖ **Departure Procedures**
- ❖ **Arrival Procedures**
- ❖ **Instrument Approach Procedures**

Creating a Binder

To create a new binder, tap the *Binder Selector* in the top toolbar. Use the + button to add a new binder and provide a name when prompted.

The binder is created and the *Plates* view automatically displays your new (empty) binder.

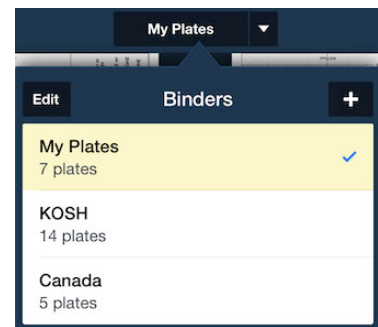

Managing Plates

There are two methods of adding plates to a binder.

The *'Tap to add plate here'* thumbnail displays an intelligent list of airports gathered from airports you've used in other parts of ForeFlight Mobile. Tap an airport to see the available plates. Tap one or more plates to add them to the binder.

The *Plate Search* box in the top toolbar allows you to search for a plate by airport, or by a specific procedure.

Example Searches:

- ❖ **KJFK** - Lists all procedures associated with the JFK airport
- ❖ **RHV GPS** - Lists the RNAV (GPS) approaches to the RHV airport

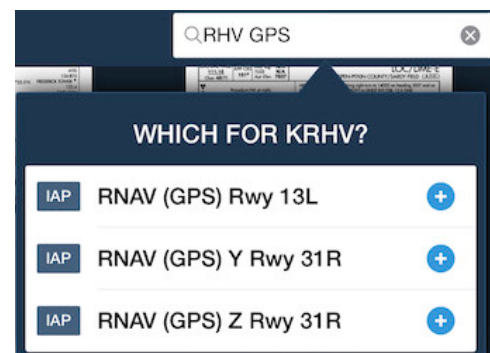

❖ **MDW ILS 13-** Displays the ILS Rwy 13C approach to MDW airport in the procedure viewer.

Tap the **+** icon to the right of any procedure to add it to the current plate binder. Tap the procedure name to view it.

To reorder or delete plates in a binder, tap the **Edit** button on the left side of the top toolbar.

To change the order in which a plate is displayed in the binder, hold and drag the plate to the new location. Note that you can add the same plate to the same binder more than once. For example, you might create a binder that contains plates for three local airports. You could elect to include each airport's taxiway diagram both before each airport's departure procedures *and* after each airport's approach plates, making it easier to find the diagram in context during both arrival and departure operations.

To remove a plate from the binder tap the **X** icon in the upper left of the plate thumbnail.

Plate Controls

To hide/show the plate controls across the top of the plate and the Instrument view across the bottom of the plate, single-tap on the plate.

The plate control buttons, including Invert Plate Colors under "Settings", are shown below:

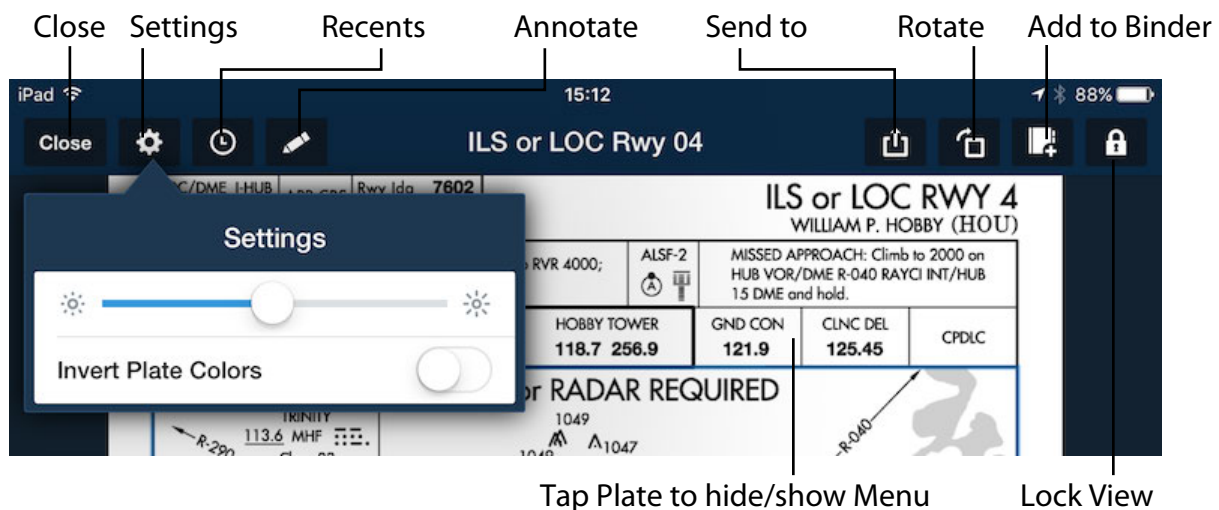

NOTAM Advisor for Approach Plates and Airport Diagrams

When you display an Approach Plate or Airport Diagram on the Plates page, ForeFlight cross checks downloaded NOTAMs and displays a warning banner at the top of the plate showing a count of relevant NOTAMs related to that plate or diagram.

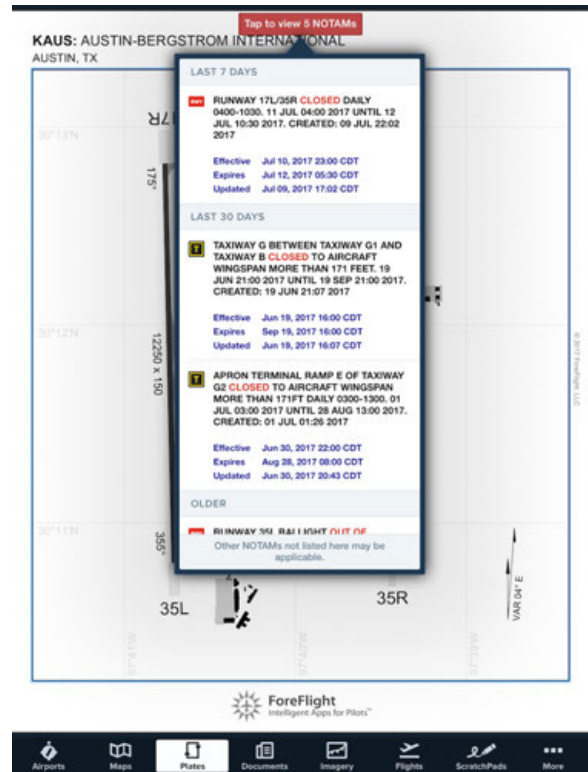
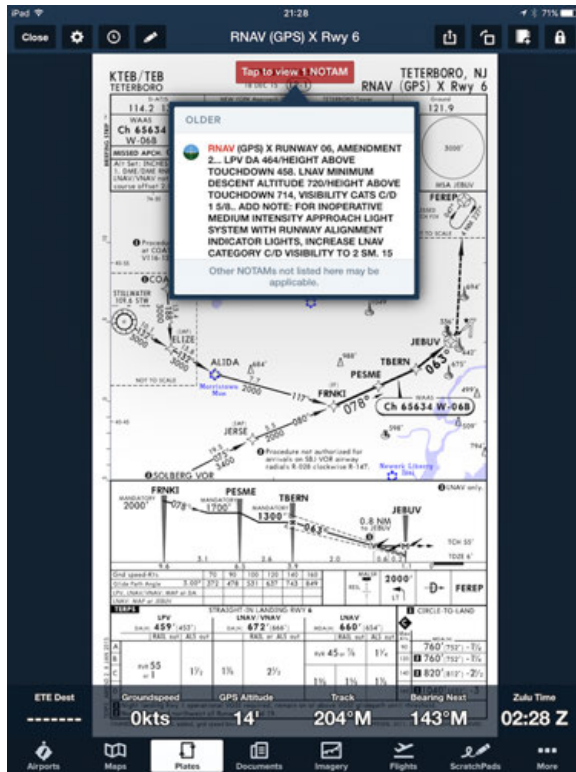

Tap the red banner to view the NOTAMs that are associated with the airport diagram or instrument procedure. Tap again anywhere off of the pop-up to close it.

FBOs on Airport Diagrams

When viewing an Airport Diagram (either FAA or ForeFlight) tap the “FBO” button at the top of the Plates menu to show/hide the location of FBOs that are known to sell fuel at that airport. FBOs can also be shown when the Airport Diagram is displayed on the Map (Pro, Pro Plus, or Performance Plus subscription required).

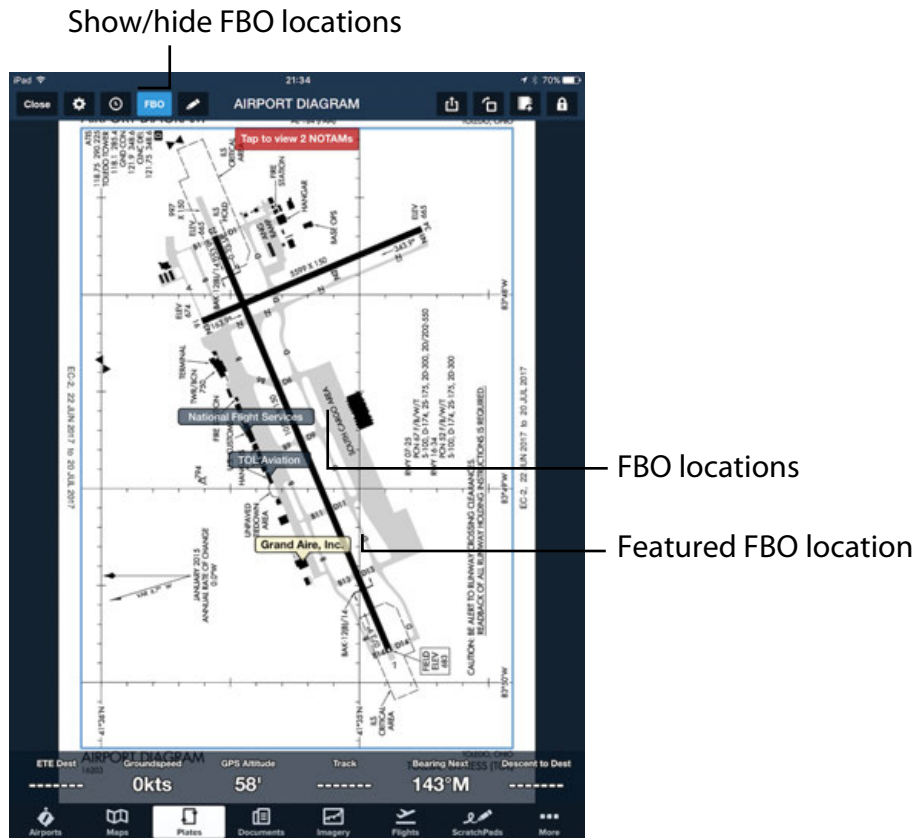

Featured FBOs are shown with a yellow flag; other FBOs are shown with a grey flag.

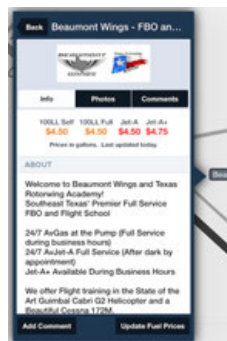

Tap an FBO's flag to open the FBO pop-up with [details about the FBO](#) including fuel prices.

Printing Plates From a Binder

Tap the **Print** button in the top toolbar of the *Plates* view. The *Printer Options* dialog box is displayed. From here, select a printer and a number of copies. Tap the **Print** button to send the selected number of copies of *ALL* plates in the binder to your printer.



To print only *one* procedure, tap the plate's thumbnail to display it in the procedure viewer, then tap the **Send To** button and choose "Printer."

Printing requires an AirPrint capable printer. For more information about this requirement, see:

support.apple.com/kb/ht4356

Ensuring Your Plates Don't Expire

When you view a plate or add it to your binder, ForeFlight uses either a copy of the plate stored locally on your iPad (by virtue of the fact that you've already downloaded it), or uses your iPad's Internet connection to fetch the plate and store it locally on your iPad. In either case, the plates are viewable *until they expire* - whether you have an Internet connection at the time you view them or not.

When these plates expire, *they are only automatically replaced if you have used the Downloads view to download new terminal procedures for the states/regions associated with the plates in your binder*. Otherwise, the plates are only replaced when you open the binder *and* have an Internet connection. In-flight is not the time to discover this.

Be sure to check your selections in **More > Downloads** to ensure ForeFlight is set to download terminal procedures for all states covered in your binders and that all requested data has been downloaded. This ensures all plates in your binder will be current and available to you at any time - on the ground or in the air.

Plates and Taxi Diagrams on a Map

About the Design

This feature allows you to overlay geo-referenced plates or airport diagrams on the Maps view. Viewing plates and taxi diagrams on a Map requires an active ForeFlight Pro, Pro Plus, or Performance Plus subscription. To upgrade, visit www.foreflight.com/buy.

In North-up mode, the plate or airport diagram is displayed on the chart right-side-up; in Track-up mode, the plate rotates along with the chart so that your ground track is towards the top of the map.

Using in-flight ADS-B or XM weather, radar and other weather information can also be displayed on the Map with the plate. Radar or Satellite can be displayed while on the ground and connected to the Internet.

You can add the waypoints on the approach by rubber-banding your route: for each waypoint, touch-hold the route line, then drag it to the waypoint and release to display the waypoint pop-up. Choose the waypoint name to add that point.

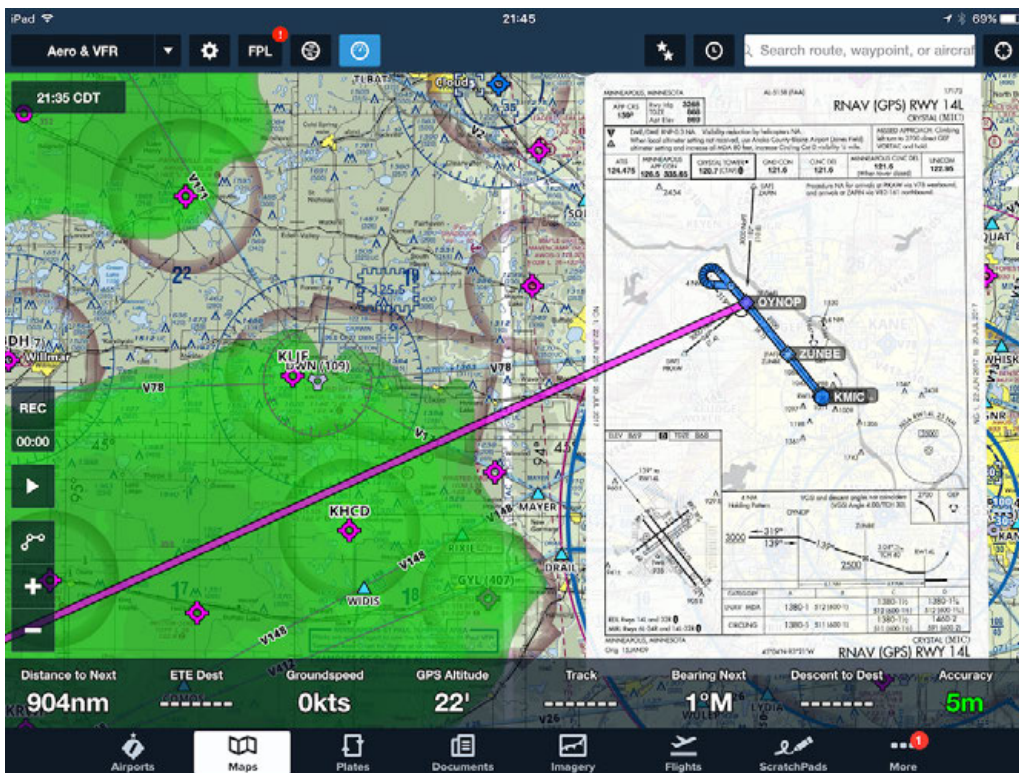

Displaying a Plate on a Map

You can display a US Approach plate or Airport diagram on the map in five ways:

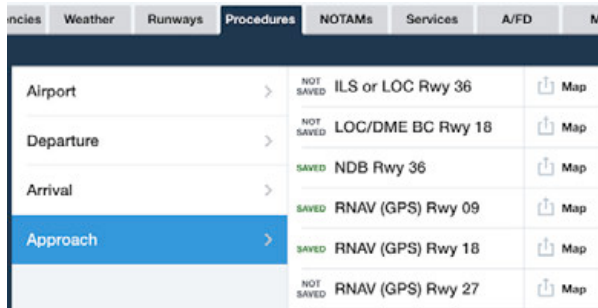

1. From the **Airports** page, tap the **Map** button next to the desired approach in the Procedures list.

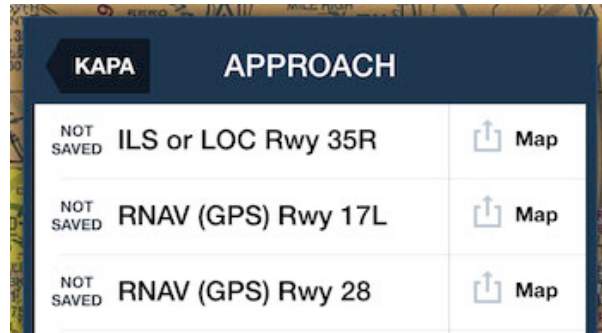

2. From the **Maps** page, tap the desired airport, then tap the grey **More** button, then the **Details** button in the pop-up to select the airport, then scroll down to the Procedures section and tap Approach. Finally tap the **Map** button next to the desired approach.

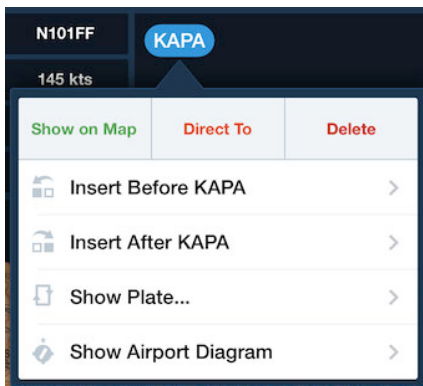

3. From the **Route Editor**, tap the colored oval and choose "Show Plate..." (or "Show Airport Diagram").

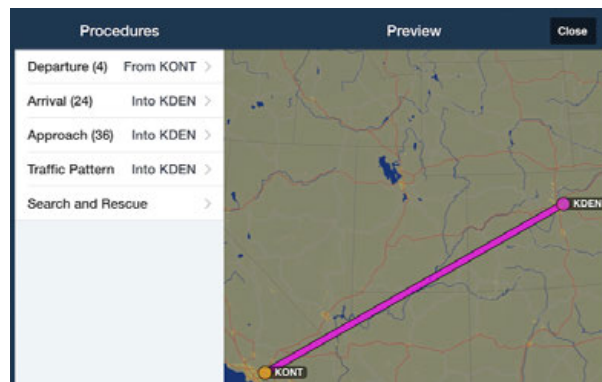

4. From the **Flight Plan Editor**, tap the Procedure Preview button then choose the Approach.

5. From the **Plates** page tap the **Send To** button and choose **Map**:

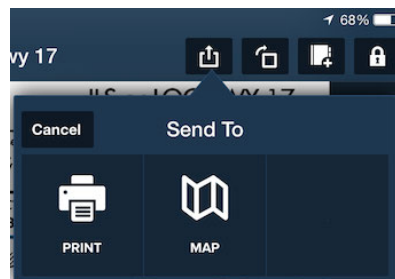

Changing or Hiding the Plate on a Map

Once you have displayed an approach plate or airport diagram on the map, you can change or hide it by

tapping the gear button  or by tapping on the plate itself to display the pop-up. There you will see the selected plate (highlighted in yellow with the checkmark) and you can scroll through the list of available plates to select a different plate. Tap a different plate to display it on the Map.

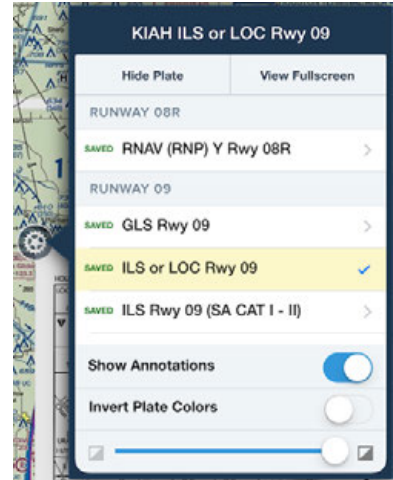

You can also tap **Hide Plate** to remove the plate from the Map, or tap **View Fullscreen** to open the plate on the Plates page. Turn **Show Annotations** OFF to hide any annotations you made to the plate. Turn **Invert Plate Colors** ON for easier viewing in low-light situations, and you can adjust the transparency of the Plate on the chart using the slider.

Adjusting Plate Transparency

Once you have displayed an approach plate or airport diagram on the map, tap the Map Settings “gear” button to adjust the transparency of the plate from fully opaque (completely covers the underlying map) to more transparent so the underlying map shows through. You can also adjust the transparency of the Radar layer (if selected).

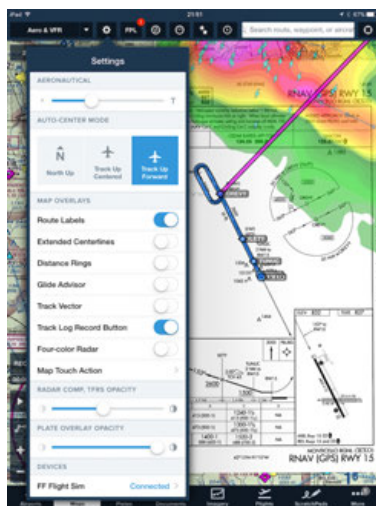

Fully-opaque (slider to right)

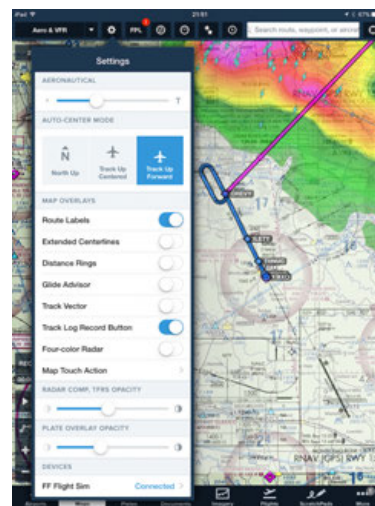

Mostly Transparent (slider to left)

Track Logs

About the Design

Track Logging records details about your flight including track and altitude using any compatible GPS, such as an external device like a Stratus 2S, or your iOS device's internal GPS. Track Logs are synchronized across your devices using Sync. Track Logs can be sent to Facebook, Twitter and via email, are available for viewing and downloading at the ForeFlight website, and can be exported to apps like CloudAhoj and Google Earth, as well as to KML and GPX files. Track Logs can also be imported to ForeFlight Logbook as new entries if it is part of your subscription.

Track Logging is very efficient: the log files require less than 300KB per hour recorded.

Enabling Track Logging

Track Logs can be enabled for either manual or automatic recording. tap **More** > **Settings**, then scroll to the **Track Log** section. To enable manual recording, switch Enable Start/Stop Control to **ON**. When this setting is **ON**, the REC button and a timer indicating the length of the current recording are shown in the lower-left corner of the Maps view above the zoom buttons. To enable automatic recording, switch Enable Auto Start/Stop to **ON**.



Start/Stop Logging

When automatic recording is enabled, a new Track Log is started as soon as the app detects a takeoff, which corresponds with a certain speed threshold. A new Track Log can also be started at any speed by tapping the REC button. In either case the REC button turns blue and the timer starts counting up, indicating the length of log file. The recording continues until the REC button is tapped again, or until the app detects a landing, which is also associated with a speed threshold.



With automatic recording, your location data prior to takeoff and after landing are added to the front and back of the Track Log, respectively, to account for taxiing. This extra recording time at the front of a Track Log is reflected in the timer upon takeoff.

When using the built-in GPS or a Bluetooth GPS, the recording will continue even if you switch to another app. **NOTE:** background recording is not currently available when using a Stratus device for GPS. If you put ForeFlight Mobile in the background

or quit it completely while recording a track log, the recording will stop or be incomplete.

If you put ForeFlight Mobile into the background while logging, verify that the REC button is still blue (Recording) when you re-open ForeFlight Mobile.

Flight Time Instrument

The “Flight Time” instrument can be used in conjunction with track logging to display actual flight time. When Track Log recording is enabled, either manually or automatically, the Flight Time instrument will begin counting up from zero after you take off and continue counting until you land or the Track Log recording is stopped.



Track Log Listing

Tap **More > Track Logs** to see a list of the available Track Logs. Each log entry shows the date it was recorded, the length of the recording in hours and tenths of an hour, the GPS source, and the aircraft’s tail number, if it has been entered or automatically captured from ADS-B Out.

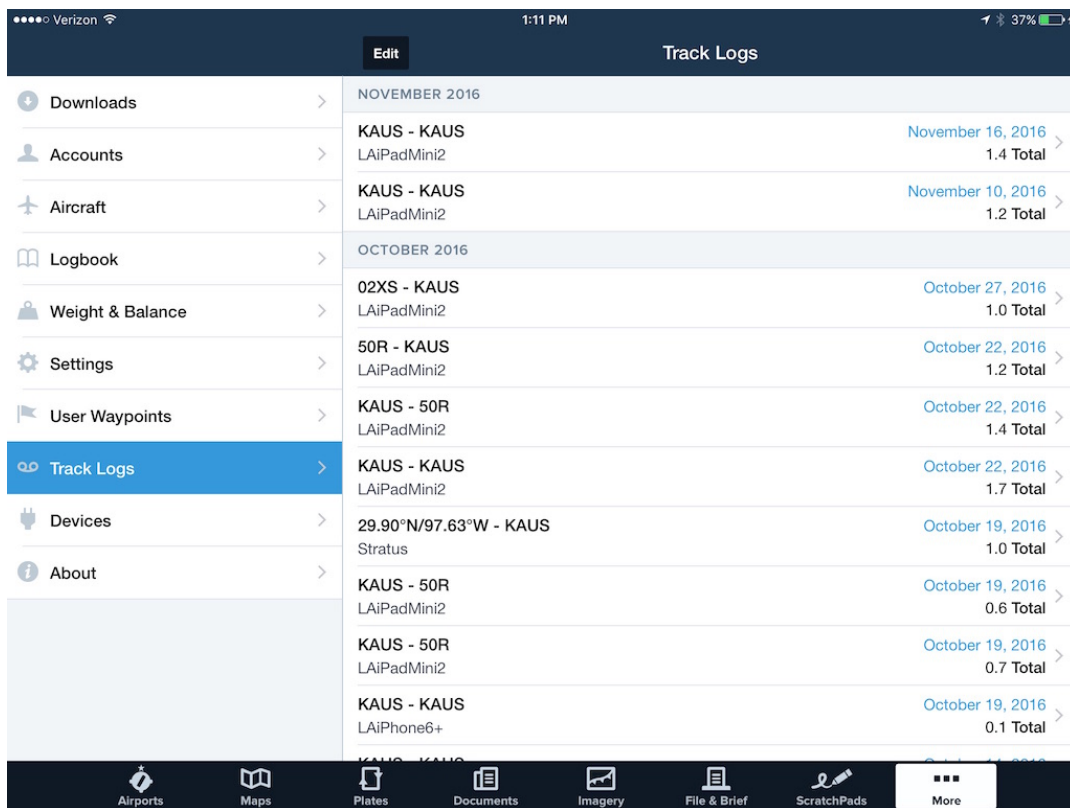

You can delete a Track Log using swipe-delete: swipe your finger from right to left across the listing, then tap the red “Delete” button. **IMPORTANT:** Once you swipe-delete a Track Log, it is gone forever, and will no longer be available via Sync or on the ForeFlight website.

Tap a Track Log to see and edit basic information about it. Track Logging makes a “best guess” as to the starting and ending airports, but you can change those by tapping and typing over the default entry.

You can also change the name of the Track Log to something more descriptive, and add additional information such as Pilot’s Name, Tail Number and Notes. If ForeFlight detects ADS-B Out capability for your aircraft it will automatically capture the tail number and add it to the Track Log.

All changes you make to a Track Log will be sync’d to the other devices on your account.

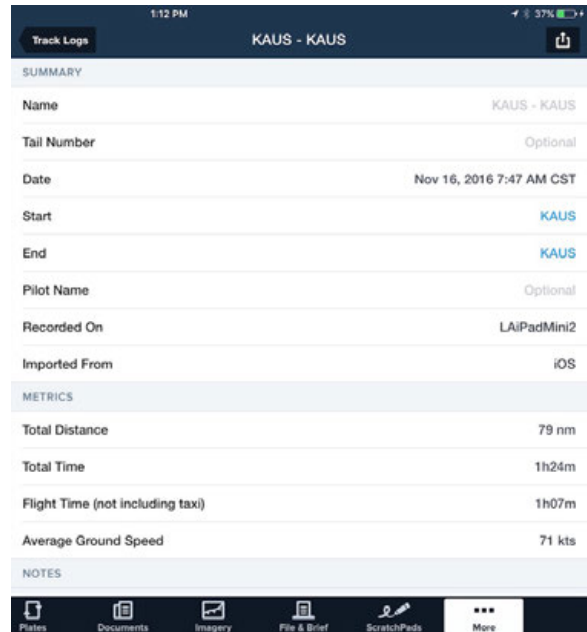

Synchronizing Track Logs to other Devices

Newly-recorded Track Logs are automatically uploaded to the ForeFlight Cloud when your device connects to the internet after a flight. You can then view and edit the Track Log’s information on other devices on your account, as well as import it to ForeFlight Logbook, share it on social media, view it on ForeFlight’s site, and email a link to the Track Log.

Emailing the full Track Log or opening it in another app on your device require that you download the Track Log’s file; a pop-up when selecting one of these options prompts you to download the Track Log.

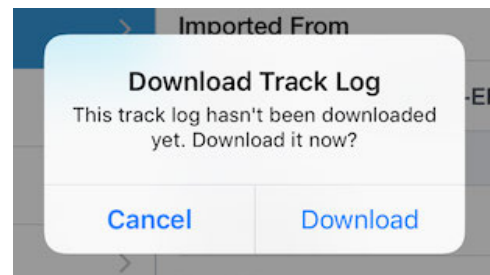

Viewing a Track Log on an iPad or iPhone

When viewing a Track Log's details, tap the Send To button in the upper-right corner and tap the "foreflight.com" button to open Safari and view a summary of the flight on the ForeFlight website.

Tap the Chart selection button  in the upper-left corner of the map to choose between Street Map, Aerial (Satellite) Map, US VFR charts, and US IFR Low and High charts.

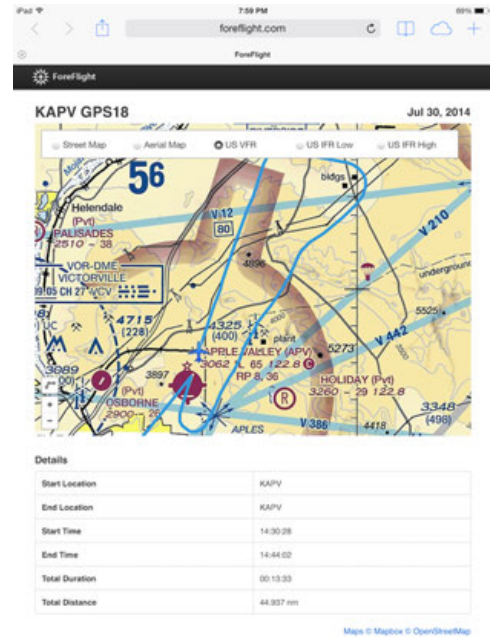

Sharing Track Logs

Track Log details can be shared via email, Twitter, and Facebook (provided you have set up your accounts in Apple Settings). Tap the Track Log entry, then tap the Send to button in the upper-right of the screen and choose how you would like to share the Track Log. You can also send the Track Log to your logbook, which creates a new entry and auto-populates it with the Track Log's details. **NOTE:** iOS 10 and earlier show Facebook and Twitter as separate items in the Send To menu; iOS 11 and later show an "Other" option which includes Facebook, Twitter, and others.

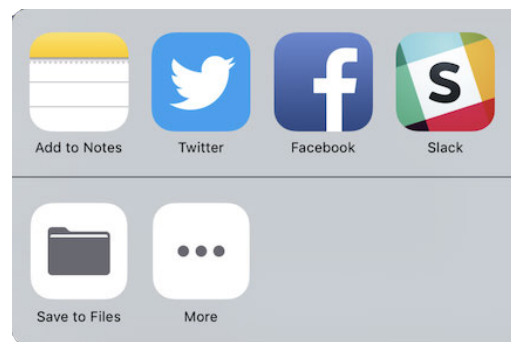
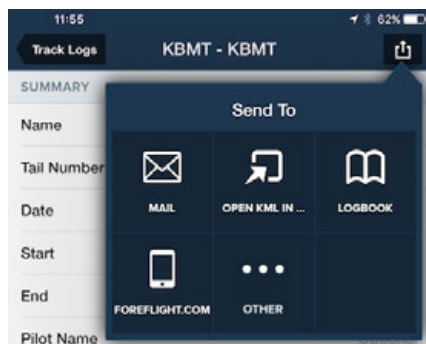

When sharing the full Track Log via email, a KML file of the Track Log is attached to the email, along with the a link to view basic information about the Track Log on the ForeFlight website.

Exporting Track Logs to other Apps

Tap the Track Log entry, then tap the Send To button in the upper-right corner to export the data to CloudAhoj, Google Earth, or other compatible apps.

Google Earth is an excellent resource for viewing the 3-D view of the Track Log on your device.

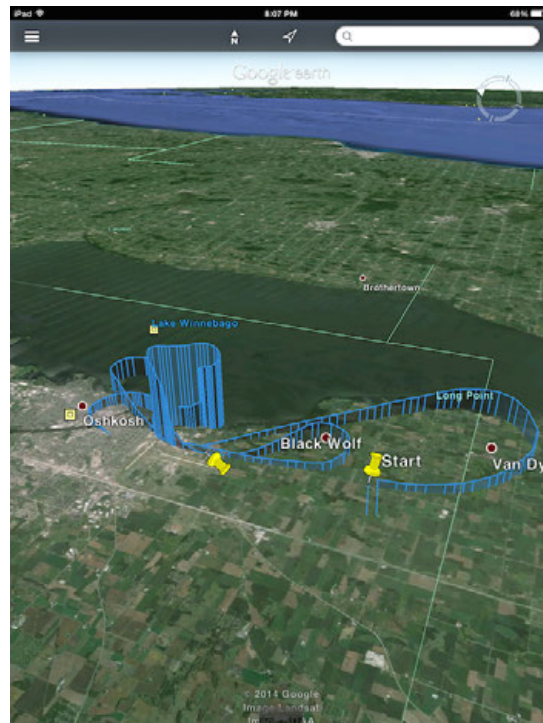

Viewing Track Logs in ForeFlight on the web

Sign in to your ForeFlight account by clicking the Login button at www.foreflight.com, then click on the “Track Log” menu item to view all of the Track Logs on your account. Click the track log you want to view from the list on the left.

The screenshot displays the ForeFlight web interface. On the left is a dark sidebar with navigation options: Maps, File & Brief, Aircraft, Logbook, Track Logs (selected), Users, and Acme A. Below these are Send Feedback and Logout buttons. The main content area is titled 'KDWH → KDWH'. At the top, there are filters for Start Date and End Date. A list of track logs is shown, with the selected log highlighted in blue: 'KDWH → KDWH, Aug 8, 2016 00:20:11 UTC, Total Duration: 01h 08m, Total Distance: 112.51nm'. To the right of the map is a 'Download' menu with options: KML (Filtered), KML (Full), GPX, and CSV. Below the map, the 'ROUTE' section shows '60R KDWH 160kts 12gph N123TS 5000ft'. The 'SUMMARY' section contains a table with the following data:

SUMMARY			
Start Time	00:20:11 UTC	Average Speed	112.36 kts
End Time	01:28:50 UTC	Recorded On	FF iPad
Total Duration	01:08:38	Imported From	iOS
Total Distance	112.51 nm	GPS Source	iOS

The 'ACCURACY' section shows: Maximum Vertical Error 19 m and Maximum Horizontal Error 10 m.

Click on the “Download” button in the upper-right then choose one of the KML options, GPX, or CSV to download the Track Log file in that format.

Documents

About the Design

The Documents view provides access to legends, manuals, or just about any document you wish to bring with you. This view enables you to organize documents in the way that makes the most sense to you, bookmark areas of interest inside of a document, and quickly switch between reading a document and other app views.

Documents from the FAA, NAV CANADA, and ForeFlight are provided in the Catalogs view. These include useful supplemental materials like the Digital Terminal Procedures Supplemental, Class B enhancement graphics, and Aeronautical Information Manual. The Catalog view also includes any PDF, image, or Microsoft Office documents you have imported into ForeFlight Mobile from iTunes or apps like Safari, Mail, or Dropbox. NOTE: Microsoft Office documents can be viewed, but unlike PDF documents they cannot currently be annotated.

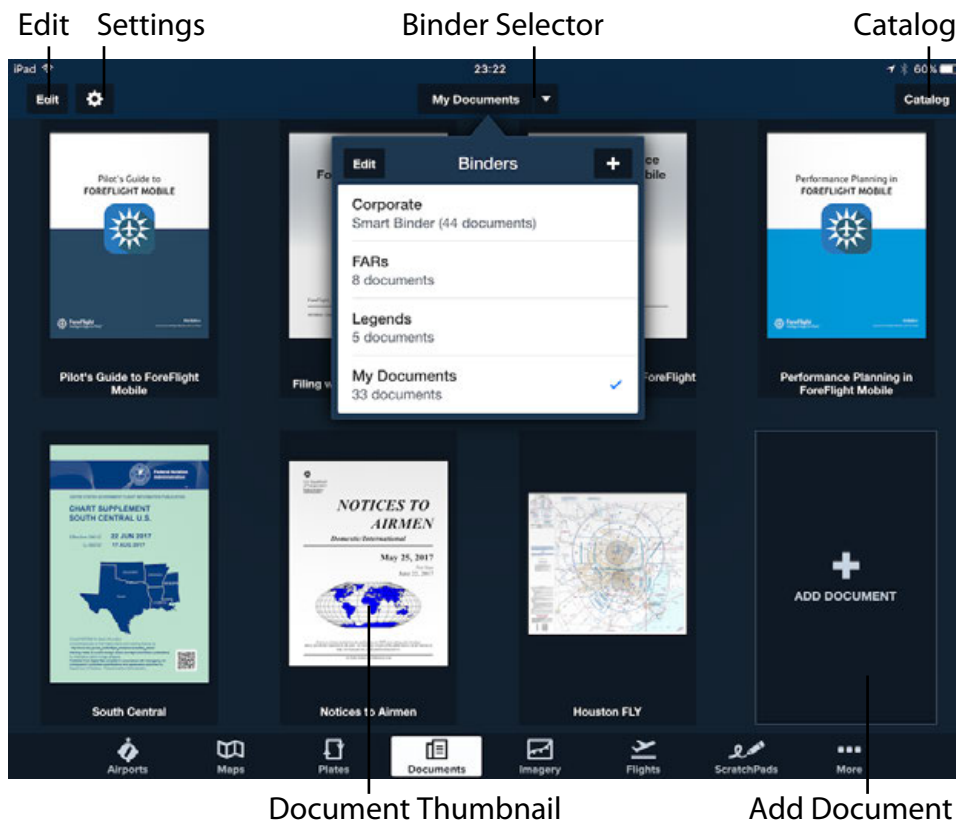

About Document Binders

Binders provide a method for organizing documents into logical groups for easy access while in flight. A document binder can contain any combination of:

- ❖ **FAA Documents**
- ❖ **NAV CANADA Documents**
- ❖ **ForeFlight Documents**
- ❖ **Imported PDF files**
- ❖ **Imported image files (PNG, JPG, TIF, GIF)**
- ❖ **Imported Microsoft Office documents (XLSX, DOCX, PPTX)**

Creating a Binder

To create a new binder, tap the *Binder Selector* in the top toolbar. Use the + button to add a new binder and provide a name when prompted.

The binder is created and the *Documents* view automatically displays your new (empty) binder.

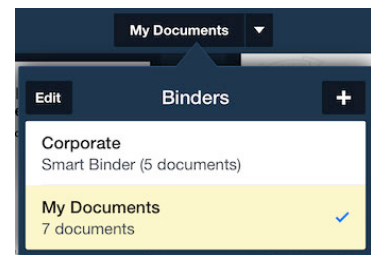

Adding Documents from a Catalog

The Catalog view lets you add documents to your binder from the FAA, NAV CANADA, or ForeFlight catalogs. If you have a ForeFlight Pro, Pro Plus, or Performance Plus subscription, see [Document Syncing](#) for details about automatically adding documents to ForeFlight Mobile.

The Catalog view also lets you add documents to your binder that you have previously imported into the app. You can bring up the Catalog view by tapping the **Catalog** button in the top-right corner, or by tapping the 'Tap to add doc here' thumbnail at the bottom of your binder.

The Catalog view has two panes. On the left pane is a list of the available catalogs. Tap the



catalog name to view that catalog. On the right pane is the list of documents for that catalog.

Tap the  icon to the right of any document to download the document. After the download is complete, it will be added to your current binder.

Tap the  icon to the right of any document to add it to the current binder. This icon indicates that the document has already been downloaded to your iPad, but is not included in the current binder.

The  icon indicates that the document has been downloaded and is already in the current binder.

If you wish to delete a document from your iPad and from all binders, find the document in the Catalog view, swipe from left-to-right on the name of the document, and then tap the red **Delete** button.

Document Syncing

If you have a ForeFlight Pro, Pro Plus, or Performance Plus subscription, you can link your ForeFlight account to a Dropbox, Amazon S3, or Box account (free or paid) at <https://plan.foreflight.com/account> and click on the Integrations tab, then click “Manage.”

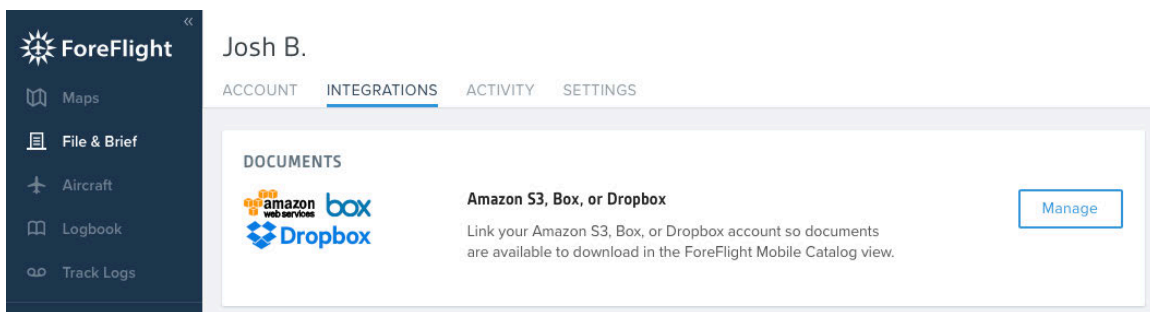

Click the “Connect” button (which shows if there is not yet a connected account) to link your document storage account to your ForeFlight account. If your ForeFlight account has already been linked, click the “Manage” button to manage the Catalog name (which is the name of the Smart Binder shown in the app), change sharing options, or to un-link the account.

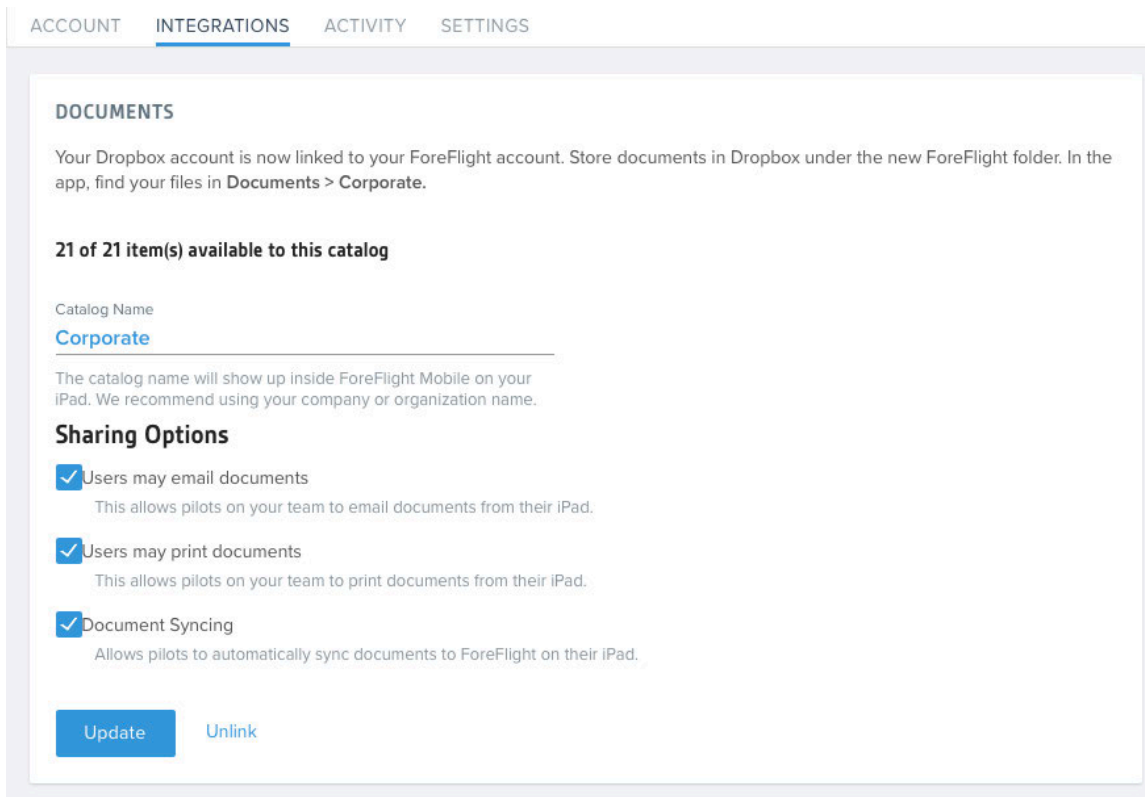

Once linked, any compatible documents you place in the appropriate folder on your computer are automatically shown in the Smart Binder download list in ForeFlight Mobile. The Smart Binder name is set to whatever you enter in the “Catalog Name” box.

Computer folder locations where documents should be saved:

Dropbox: /Dropbox/Apps/ForeFlight

Box: /Box Sync/ForeFlight

Amazon S3: folder is selected at the time of account linkage

If you do not want document to synchronize automatically with the Smart Binder in ForeFlight Mobile, un-check the “Document Syncing” option:

When “Document Syncing” is un-checked, any documents in the Smart Binder in ForeFlight Mobile remain unchanged, and the pilot can manually add documents to or remove them from the Smart Binder.

When “Document Syncing” is checked, any documents that had been manually added to the Smart Binder when “Document Syncing” was un-checked will be removed, and the Smart Binder will automatically be updated and synchronized to match the sync’d folder. Any changes or updates you make to a document in the sync’d folder on your computer will be synchronized to ForeFlight automatically.

Whenever new documents are added to your sync'd folder, ForeFlight Mobile will display a red dot with a number in it on the corner of the More tab, and on the Downloads section.

To download individual documents into the Smart Binder, tap on the **Documents** tab, then tap the **Binders** drop-down to choose the Smart Binder. Then tap on the rectangle with the document title that you wish to download. To download ALL listed documents into the Smart Binder, tap the Download button in the upper-right corner of the Smart Binder. The Download button is only visible when the Smart Binder is selected.

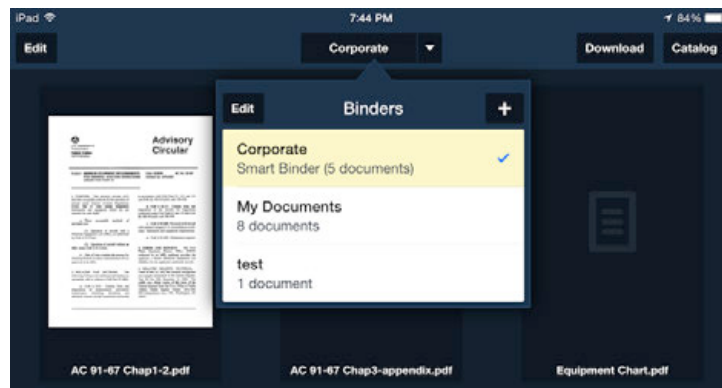

Or tap More > Downloads, then tap the blue "Download" button to download the new documents.

Documents listed in the Smart Binder can also be saved into another binder: switch to the other Binder using the **Binders** drop-down, tap the **Catalog** button, then select the name of the Smart Binder from the category on the left of the screen, then tap the Document title. Saving a document in another location does not make a 2nd copy of it, so can be done without worry of filling up storage space.

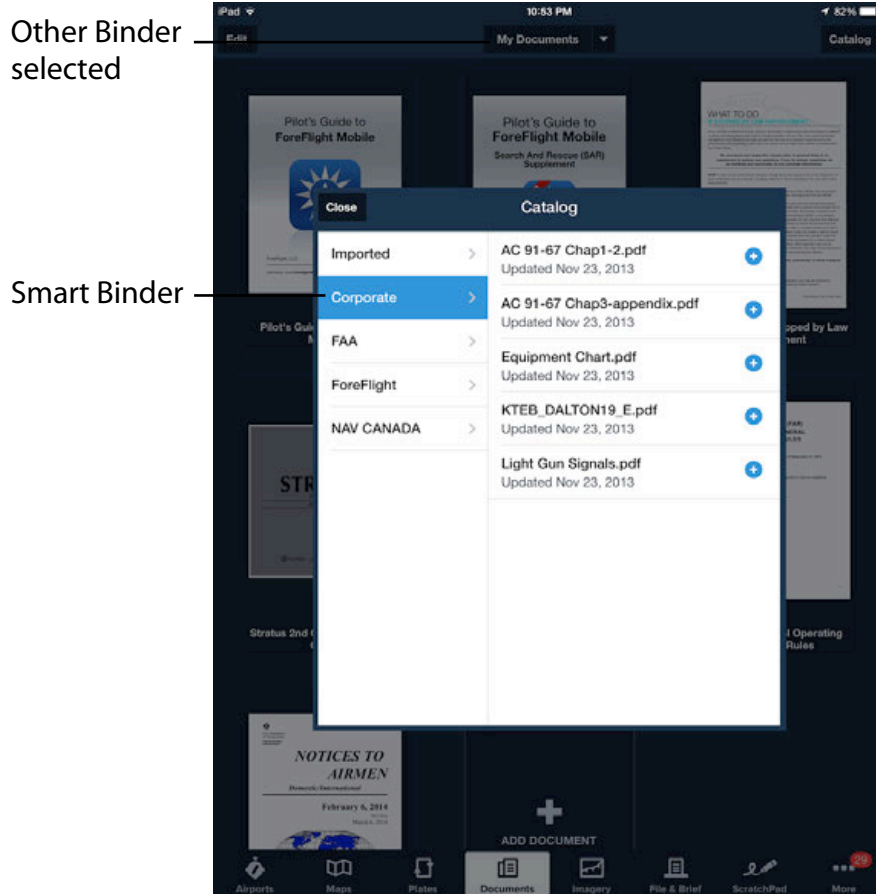

After a document is removed from the sync'd folder your computer, it will also be automatically deleted from any iPads that have downloaded it the next time the iPad(s) connect to ForeFlight's servers via the Internet. The removed document(s) will be deleted from both the Smart Binder and any other binders where the document(s) had previously been saved.

If the sync'd account is un-linked from your ForeFlight account, all sync'd documents are retained on the iPads that had downloaded them. The documents will remain on the iPad until they are either deleted by the pilot, or the pilot signs-out of their ForeFlight account on the iPad. Signing-out removes all sync'd documents.

If a sync'd account is un-linked but then re-linked with a different name than before, a new Smart Binder will be created on all signed-in iPads. To remove the "orphan" Smart Binder, change to More > Downloads and swipe-delete the individual documents in that "orphan" Smart Binder. Once all documents in the "orphan" Smart Binder have been deleted, quit and restart the app to automatically remove the Smart Binder. Or, sign out of your ForeFlight account in More > Accounts to remove all of the documents in the "orphan" Smart Binder, as well as the "orphan" Smart Binder.

Importing Documents from iTunes or other Apps

You can import PDF, JPG, TIF, PNG, and GIF files into your document binders using iTunes, and you can import PDF documents from other apps.

❖ **Importing from iTunes** - Plug your iPad into your computer using the Apple USB cord and start iTunes on the computer. Inside iTunes, click on the name of your iPad under the Devices listing on the left. On the right pane, click the Apps tab at the top. Scroll to the File Sharing section at the bottom of the page and click on ForeFlight. On the right, you will see a table titled ForeFlight Documents. Drag and drop your files onto this table. While the files are copying over, you will see a brief Sync in Progress message on your iPad. After the copying has completed, launch ForeFlight Mobile and tap on the Documents tab. The files will be imported into the app and appear at the end of your current binder. After a file is imported, it will disappear from the iTunes listing.

You can import PDF (but **not** JPG, TIF, PNG or GIF) files from other apps, such as Safari, Mail, or the Dropbox app.

❖ **Importing from other apps** - Send yourself the PDF document via email as an attachment, open the email on the iPad, then tap the PDF icon, or touch-hold the PDF document if it is displayed to show the “Open in” pop-up menu. Then tap “Open in ForeFlight.”

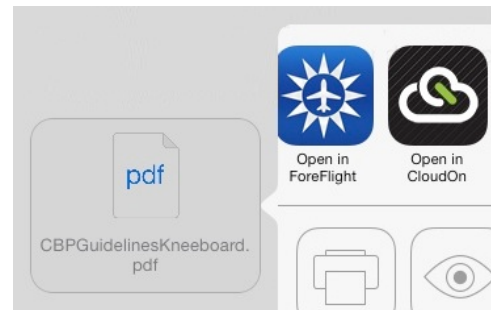









If a document does not import, make sure it is a supported file format: PDF, JPG, TIF, PNG, GIF. Very large image files or PDF files containing scanned images may open slowly, especially on earlier iPad models.

After a document is imported, it is always added to the current binder. To also add it to a different binder, open that binder, tap the **Catalog** button at the top right, and select that document from the **Imported** catalog. Imported documents cannot be added to a Smart Binder.

Viewing a Document

Tap any document thumbnail in a binder to launch the ForeFlight Document Viewer. This viewer supports standard pinch and expand zooming, and panning touch gestures. Swipe left and right with a single finger to change pages. You can close the document by pinching (zoom out gesture) from the view on any page and you can open a document by expanding (zoom in gesture) from the Binder view.

Tap once on a document page to bring up the toolbar at the top and page scrubber at the bottom. Tap again on the document to hide these overlays.

	Settings: shows the screen brightness slider, and the Invert Document Colors switch for better low-light viewing of documents.
	Shows the table of contents for a document (if available) and any pages you have bookmarked. This menu is only shown for PDF documents.
	Toggles between full page view and thumbnail view, which shows a thumbnail for each page in the document. This button is only shown for PDF documents.
	Display the Annotation menu. This button is only shown for PDF documents
	Search for text in the document. This button is only shown for PDF documents
	Bookmarks a page in the document. This button is only shown for PDF documents.
	Shows a menu for Printing or Emailing a document. Emailing is not available for copyrighted document catalogs.
	Disables touch interaction (zooming and scrolling), which minimizes the risk of accidental closure when in turbulence. It also disables the automatic rotation that would normally occur when the iPad is turned. The lock button can also, optionally, disable all buttons on the screen, including those that change views. That feature is configured in Settings ("Lock Disables Buttons").

Document View Toolbar Buttons

At the bottom of the screen, the page scrubber shows thumbnails for each page and lets you quickly jump around in your document.

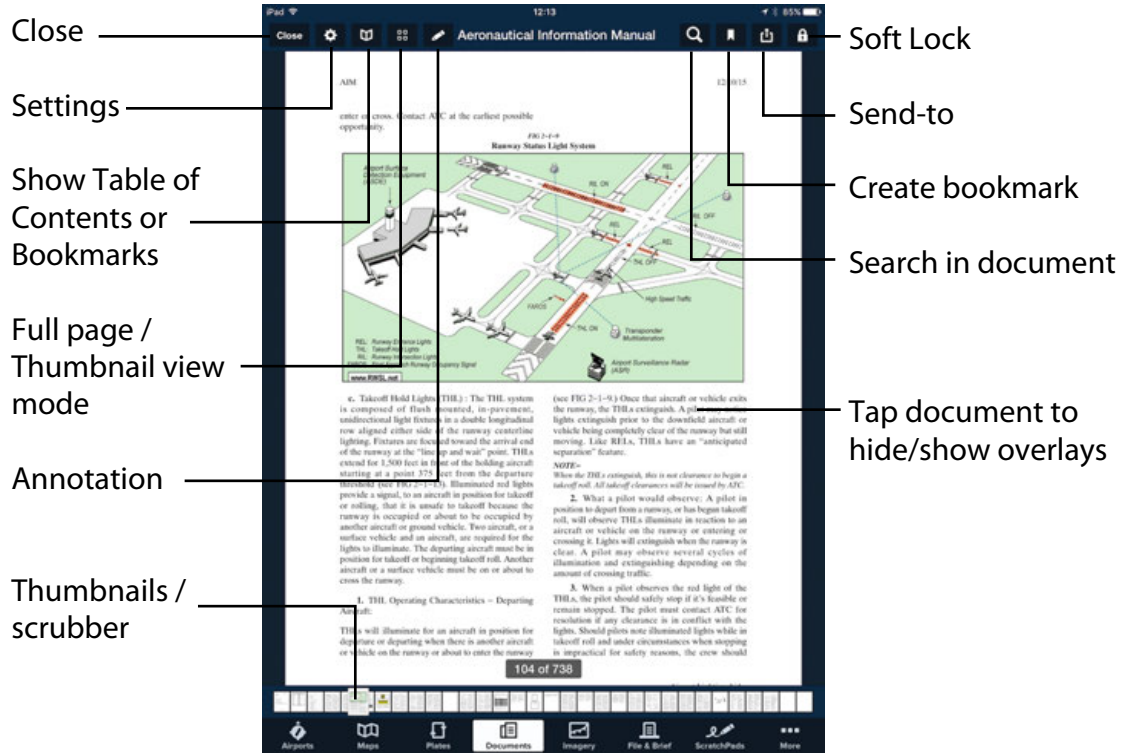

Searching in a Document

Tap the Search button  to display the search box, then enter your search term(s). All matches will be shown in the scrollable expanding list. Tap the entry to jump to the desired page, where the search term(s) will be highlighted in yellow.

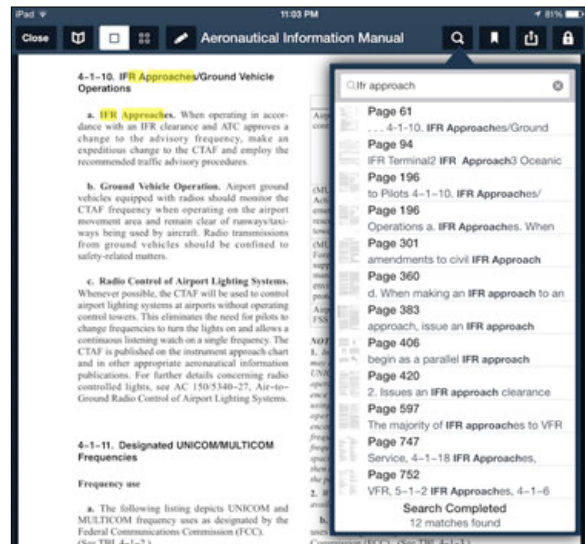

Adding and Removing Bookmarks

While viewing the page you would like to bookmark, tap the Bookmark button  then enter the name you would like to give the bookmark and tap the “Add Bookmark” button. View all bookmarks for the current document by tapping the Table of Contents/Bookmark button and choosing the Bookmarks filter.

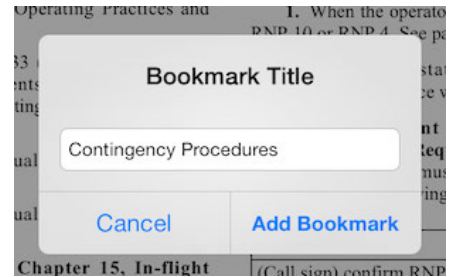

To remove a bookmark, tap the “Show Table of Contents or Bookmarks” button, then swipe-delete the bookmark you want to remove: swipe your finger across the title, then tap the red “Delete” button. Or you can tap on the bookmark you want to remove to will change to that page of the document. When that page is displayed, tap the bright-blue Bookmark button to remove the bookmark.

Managing Documents in a Binder

To reorder or delete documents in a binder, tap the **Edit** button on the left side of the top toolbar.

To change the order in which a document is displayed in the binder, hold and then drag the document to the new location.

To remove a document from a the binder tap the **X** icon in the upper left of the plate thumbnail while in edit mode. If a document is saved in multiple binders, removing a document from only one binder does not delete it from your iPad (see below for information on how to permanently delete a document).

Deleting Documents from your iPad

There are two ways to permanently delete a document from your iPad:

1. If the document is only saved in a single binder, delete it by tapping the “Edit” button in the upper-left corner, then tapping the “X” in the corner of the document. This will remove it from the binder as well as the Download list.

2. If the document is located in multiple binders, delete it by opening the Document Catalog then using “swipe-delete”: swipe your finger from right-to-left across the name of the document (or from left-to-right on iOS 6 or earlier) then tap the red **Delete** button to delete it from all binders as well as the Download list.

IMPORTANT: If you “swipe-delete” the document from the Document list on **More > Downloads**, the document will be removed from memory but immediately queued for download.

If a document is showing in the Download list but is not in a binder, you must first save it into a Binder **before** using one of the methods above to delete the document completely from the iPad.

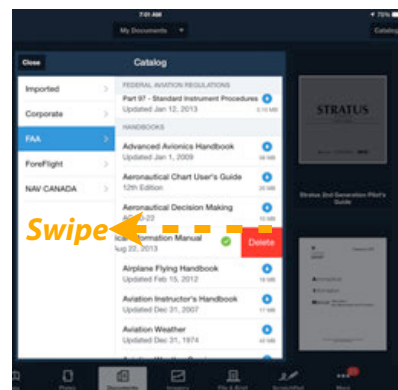
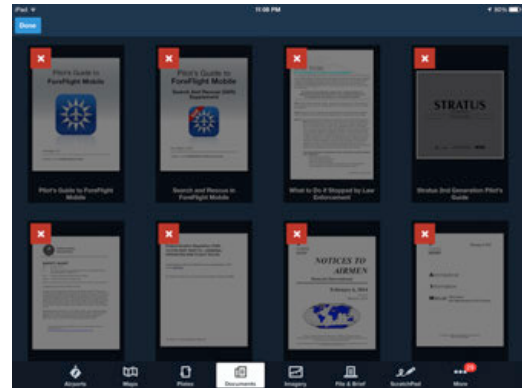

Ensuring Your Documents Don't Expire

When a new version of a document is available, a red badge will appear on the app icon and there will be a new item in the Downloads view. Tap the blue **Download** button at the bottom of the Downloads view to download the latest documents, along with any other data updates that are available.

FAA and NAV CANADA documents that are updated on a regular 28-day or 56-day cycle will be available for download a few days before the document expires. Your document binder will always show the version of the document that is effective, if it is available. Once the new version of a document becomes effective, it will automatically start showing in your binders and any old, expired versions will be deleted from your iPad.

Annotating Plates and PDF Documents

About the Design

This feature allows you to add your own full-color annotations to Approach plates, SIDs, STARs, Airport Diagrams and PDF Documents. This can be useful for highlighting important elements such as crossing altitudes or taxi instructions, or adding notes to your PDF documents.

Annotations are available in all subscriptions and require an iPad 2 or higher. Annotations are not available on the iPad 1. If you have a ForeFlight Pro, Pro Plus, or Performance Plus subscription, annotations you make on an Approach plate are displayed when you show the annotated [Plate on the Map](#).

Annotations you add to a Plate, SID, STAR or Airport Diagram are saved at the data cycle change-over, unless the SID, STAR or Plate name changes in the new data cycle (e.g., if the TEXN5 STAR becomes TEXN6, or RWY03 ILS becomes RWY04 ILS due to updated magnetic variation).

Annotations you add to a PDF Document are saved if the document is updated, provided the document title stays the same during the update.

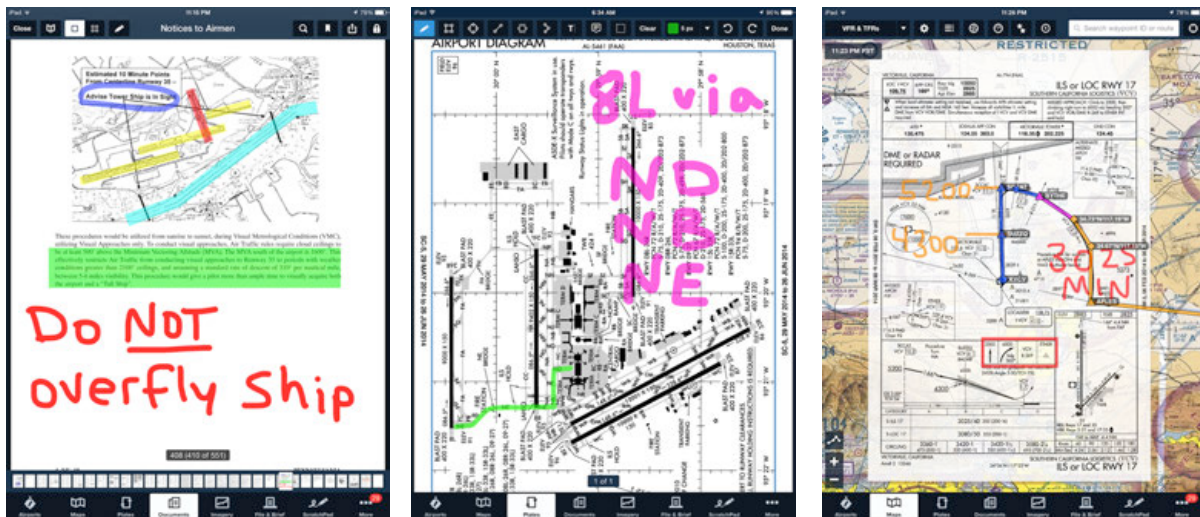

Types of Annotations

There are 8 kinds of annotations available:

Drawing 		Text Box 	
Rectangle 		Ellipse 	
Line 		Polygon 	
Polyline 		Sticky-note 	

Adding and Editing Annotations

There are two ways to add an annotation. When you open a plate or PDF Document, tap the Annotation button in the menu at the top of the page to display the annotation toolbar:

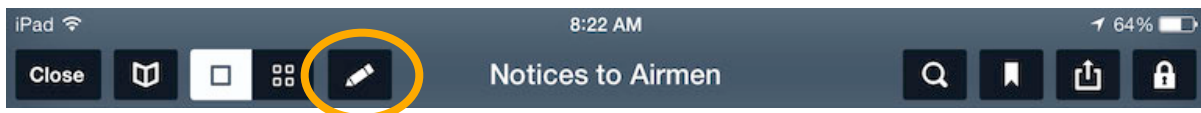

or simply touch-hold on the plate or PDF Document until the magnifying glass appears, then release your finger to display the pop-up Annotation menu:



Tap the button to choose the type of annotation you want to add (Text, Sticky note, or Ink drawing), then adjust the formatting and color of the annotation (if needed) by tapping the colored Annotation setting button (the colored dot) at the top of the page.

You can reposition an annotation by touch-dragging inside of the selection box, and you can resize the annotation by touch-dragging one of the blue “handles” around the annotation.

Choosing Annotation Color

Tap the Color drop-down in the top menu bar to display the line Color, Opacity, and Thickness picker.

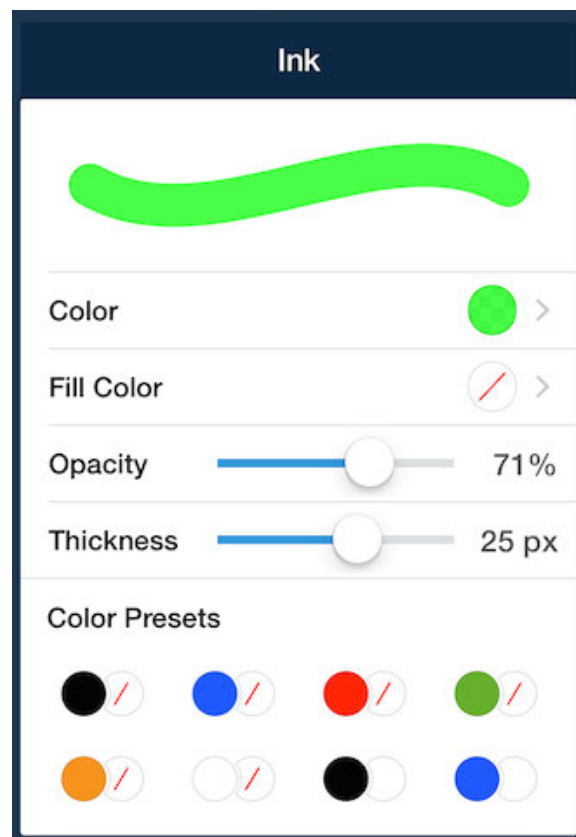

You can choose from 8 presets: six with transparent “fill” colors (with the red /) and two with white fill.

Or tap the Color button to display the color picker. Change between the 5 color selection pages by swiping from left to right.

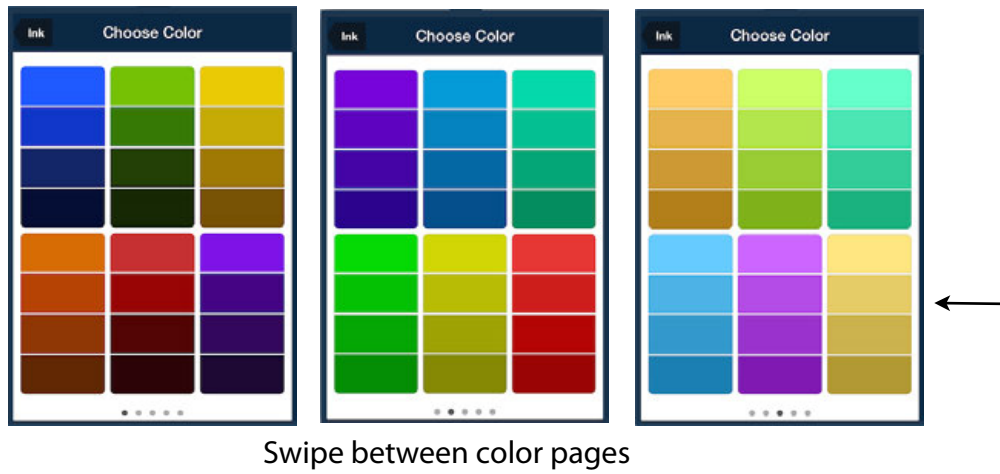

Swipe between color pages

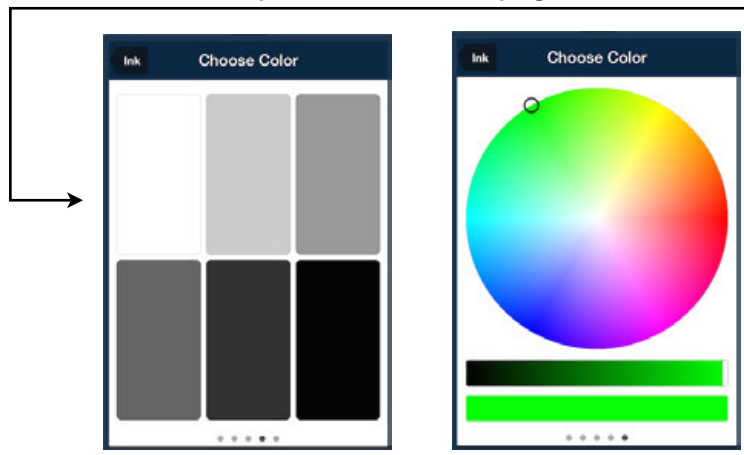

When using the color "circle", touch in the circle to choose the color you want, then slide the horizontal slider below the circle to adjust the brightness of the color.

Fill Color: Transparent or "No Fill"

To choose a transparent or "no fill" color, select the Fill Color box with the red diagonal line.

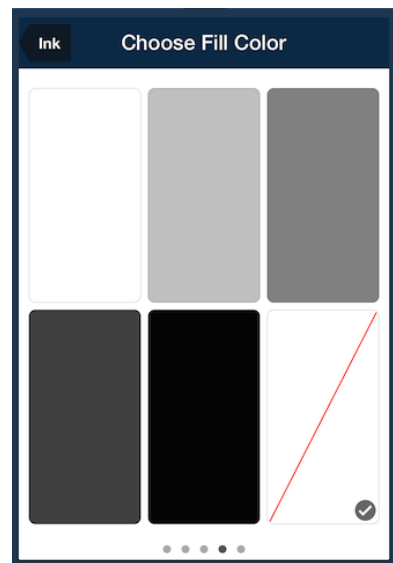

Drawing/Ink

The freehand Drawing/Ink tool allows you to choose the line Color, Opacity and Thickness. To edit a previously drawn line, tap it, then choose the "Inspector" menu.

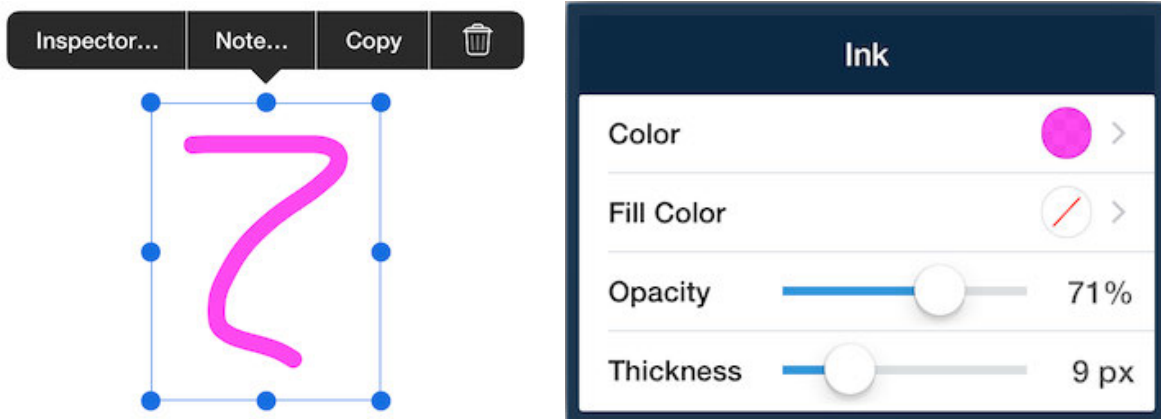

Text Box

The Text Box tool lets you pick the Text Color, the Text Box fill Color, the Opacity, the Font (Font style in a sub-menu), Font Size, text alignment, and whether a Callout line + arrow are automatically attached to the text box.

To create a text box, select the Text Box tool, tap on the Plate or Document where you want the text to appear, then type the desired text. When typing into a text box, several formatting options are available at the top of the on-screen keyboard:

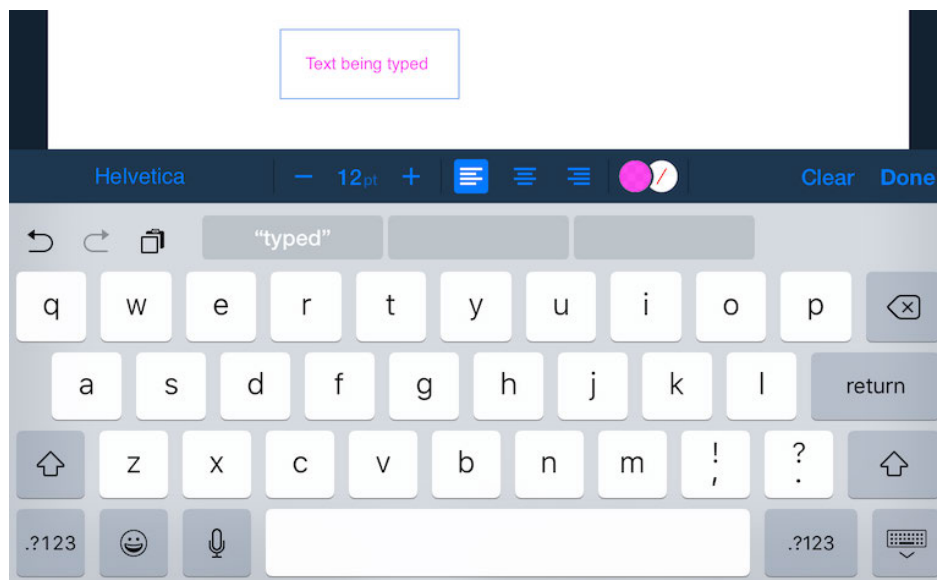

To edit a previously drawn text box, tap it, then choose the “Inspector” menu, then tap the attribute you want to change.

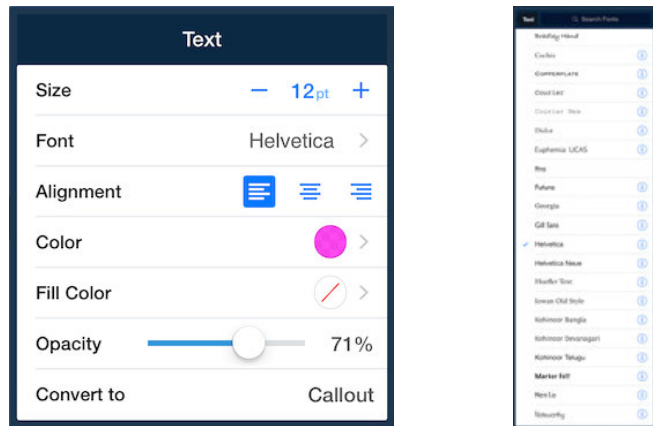

If converting the Text Box to include a Callout line + arrow, tap “Callout” in the Convert to line, then choose the Line End type.

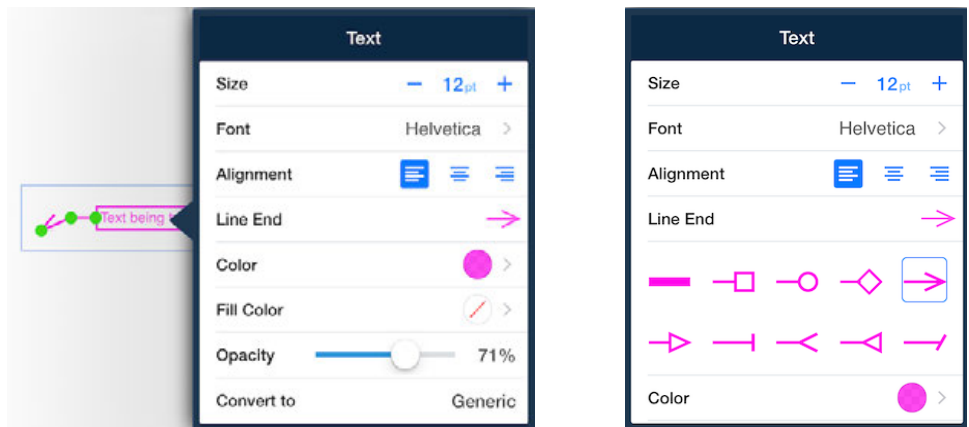

You can reposition the callout line by touch-dragging on the green “corner” points.

Rectangle

The Rectangle tool allows you to choose the line and Fill Color, rectangle Opacity and line Thickness. To draw a rectangle, touch-hold then drag your finger to make the rectangle. Lift your finger to complete the drawing. To edit a previously drawn rectangle, tap it, then choose the “Inspector” menu.

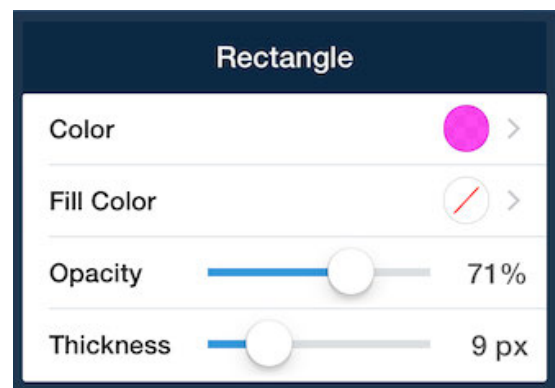

Ellipse (Circle)

The Ellipse tool allows you to choose the line and Fill Color, ellipse Opacity and line Thickness. To draw an ellipse, touch-hold then drag your finger to make the ellipse. Lift your finger to complete the drawing. To edit a previously drawn ellipse, tap it, then choose the “Inspector” menu.

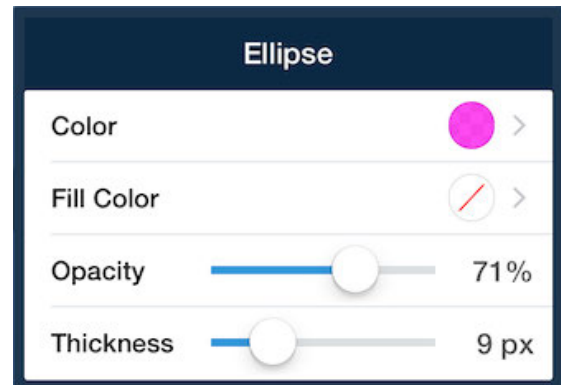

Line

The Line tool allows you to choose the line Color, Opacity, Thickness as well as start and end-point type (e.g., arrow, dot, diamond, etc...). To draw a line, touch-hold then drag your finger to make the line. Lift your finger to complete the drawing. To edit a previously drawn line, tap it, then choose the “Inspector” menu.

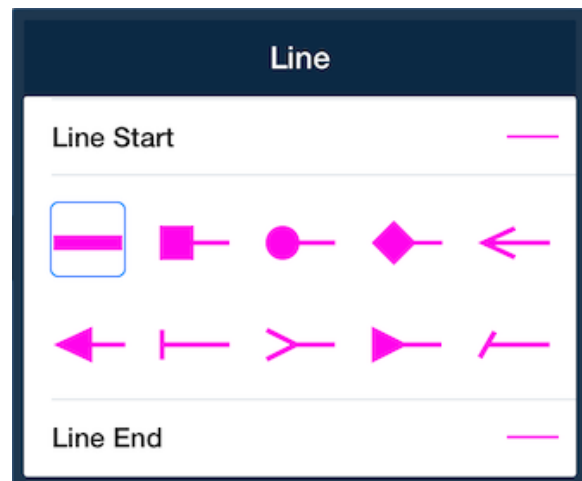
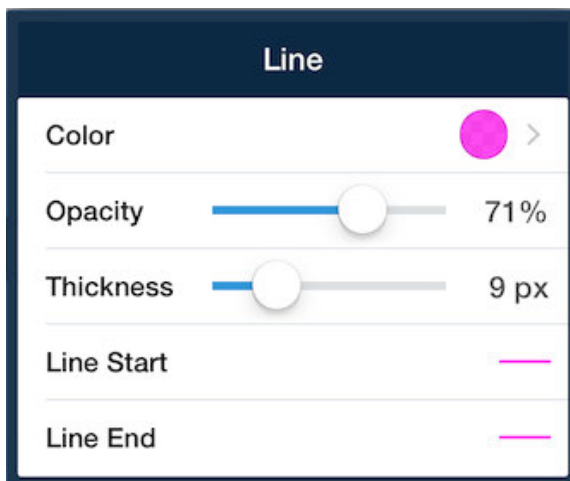

Polygon

The Polygon tool lets you choose the line and Fill Color, polygon Opacity and line Thickness. To draw a polygon, tap your finger to each desired “corner” of the polygon. Each additional tap will extend a line segment from the previous corner to the new tap. When you tap “Done” in the menu bar, a final line segment will automatically be added to “close” the polygon.

To edit a previously drawn polygon, tap it, then choose the “Inspector” menu.

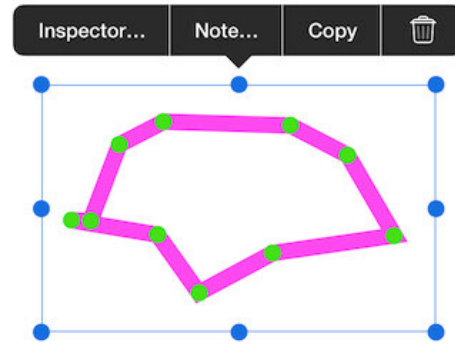
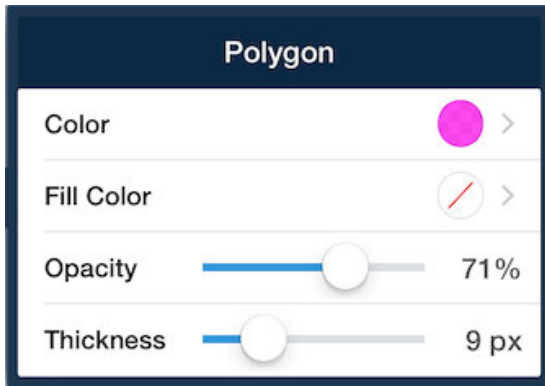

You can edit the corners of the polygon by touch-dragging the green “corner” point handle to the desired corner position.

Polyline

The Polyline tool is similar to the Polygon tool, except that the shape is not automatically “closed” when you tap “Done”, and like the Line tool you can choose the start and end-point types (e.g., arrow, dot, diamond, etc...).

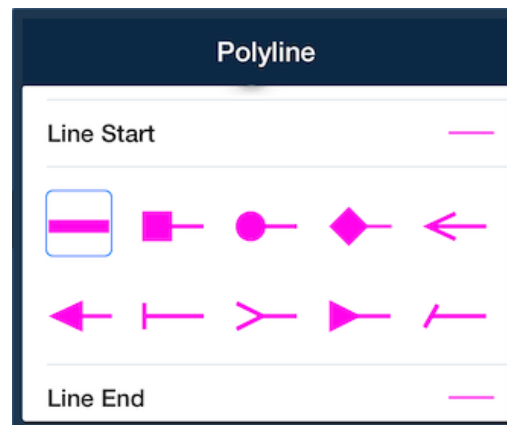
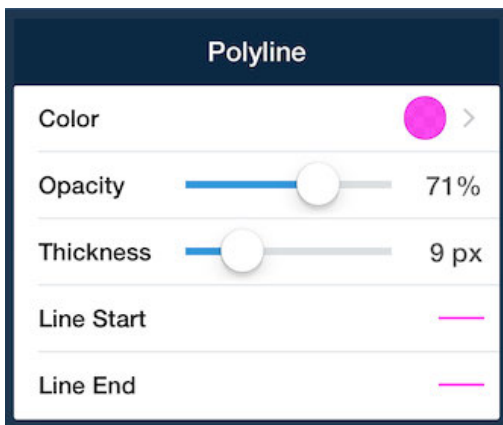

To edit a previously drawn polyline, tap it, then choose the “Inspector” menu.

Sticky-note

Tap the note icon, then tap the “Edit” button to choose the note background color and icon type. Tap anywhere not on the Sticky-note to close the Edit menu.

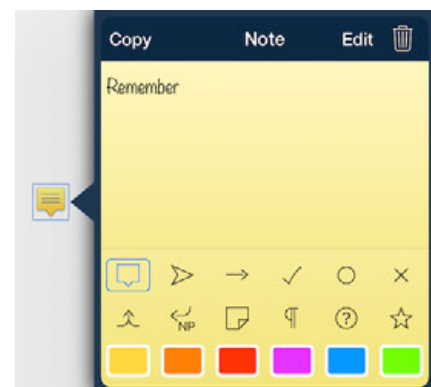

Undo/Redo

While adding annotations to a Plate or Document, tap the Undo (left) arrow button to remove recent annotation elements, and tap the Redo (right) arrow button to restore removed annotation elements.



Selecting Multiple Annotations

Tap the Selection button  then touch-drag across multiple annotations to select several at once, then tap Group to group the items together, Copy to copy all items, or the Trash can to delete the selected annotations.

Copying and Pasting an Annotation

Tap a previously added annotation to select the annotation and display the edit pop-up menu, then tap the Copy button.



Paste the copied annotation in a different location or onto a different page (or document) by touch-holding on the Plate or Document until the magnifying glass appears. Lift your finger, then tap the Paste button in the pop-up Annotation menu.

Deleting Annotations

Tap the annotation to select it, then tap the Trash-can button in the edit pop-up menu.

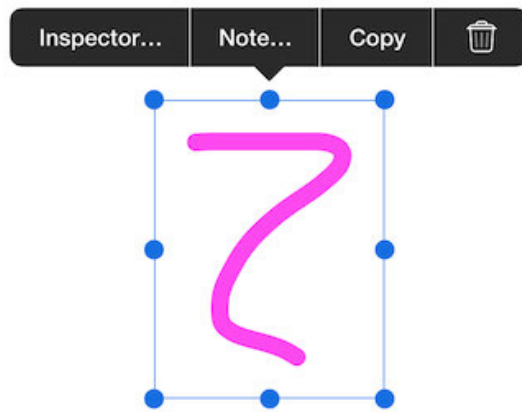

To remove all annotations from a page, tap the Annotation button, then tap Clear:

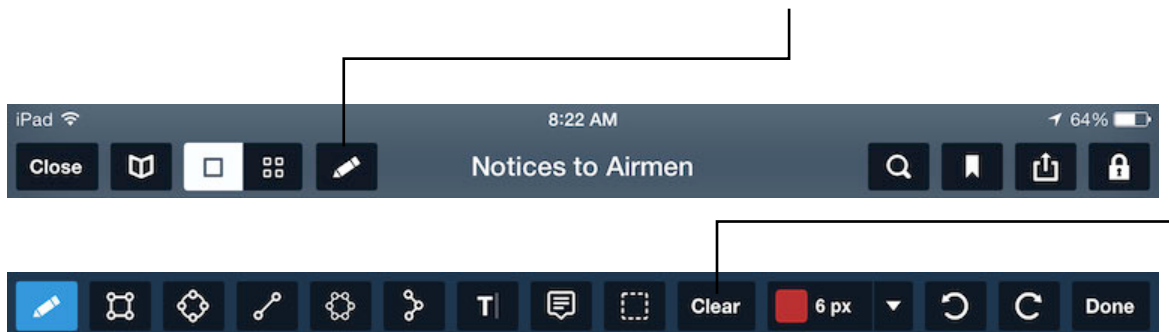

Imagery

About the Design

The Imagery view provides collections of weather images from around the globe. Images are divided into categories by type. When viewing a category a current thumbnail image is shown for each available image.

Full size images are displayed full screen and support standard pinch and expand zooming, and panning touch gestures.

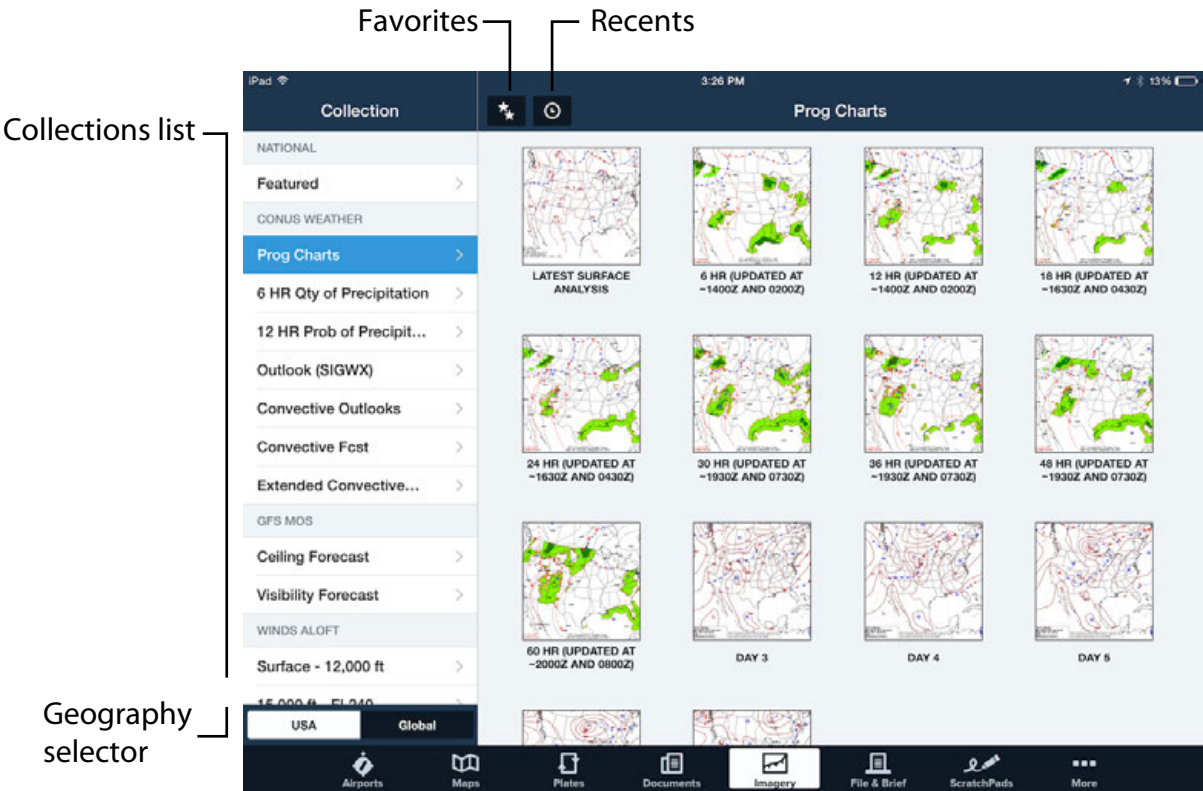

Selecting a Collection

Tap a collection in the left-side list to show thumbnails from that set on the right side. Other collections are available by tapping the USA/Global geography selector at the bottom of the list.

In addition to the previous Imagery selections, ForeFlight Mobile 7.1 adds several new Imagery Collections and chart types:

NATIONAL - Featured

Flight Category - Updated once every 30 minutes, the flight category chart highlights adverse flight conditions affecting the conterminous U.S. and southern Canada. Using colored dots this chart depicts the lowest flight category considering both ceiling and visibility for stations reporting marginal VFR (blue), IFR (red) or low IFR (magenta). Also included are recent pilot weather reports of moderate or greater turbulence (tan) and moderate or greater icing (green) using standard pilot report symbology.

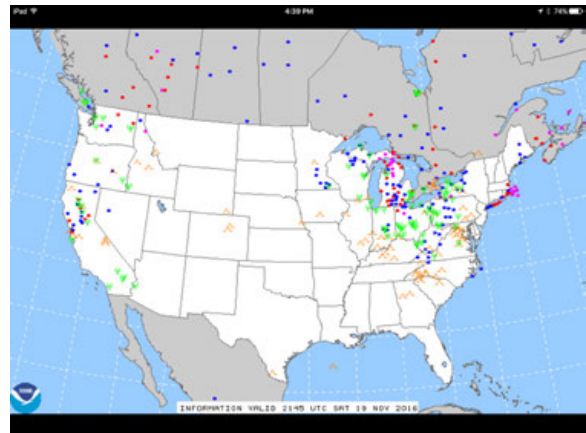

Weather Depiction chart - Issued every three hours, the Weather Depiction chart shows an analysis of the location of surface frontal systems, surface troughs, and IFR/MVFR conditions for the conterminous U.S., southern Canada and northern Mexico. Also included are station models consisting of sky coverage, ceiling height and present weather (precipitation, mist, fog).



Shaded areas are regions of IFR conditions with ceilings less than 1,000 feet and/or visibilities less than 3 statute miles. Contours without shading are regions of MVFR conditions with ceilings greater than or equal to 1,000 feet to less than or equal to 3,000 feet and/or visibilities greater than or equal to three statute miles to less than or equal to five statute miles. No contours or shading imply ceilings are greater than 3,000 feet and visibilities greater than 5 statute miles.

Latest Surface Analysis - The mean sea level (MSL) surface analysis chart is issued every three hours by a forecaster at the Weather Prediction Center (WPC). This chart depicts the synoptic and sub-synoptic/mesoscale features including the location of high and low pressure centers, fronts, troughs, outflow boundaries, squall lines, dry lines and an isobaric analysis. The domain includes much of North America, the Western Atlantic and Eastern Pacific oceans and the Gulf of Mexico. This analysis is valid at the synoptic times of 0000 UTC, 0300 UTC, 0600 UTC, ..., 2100 UTC. The latest surface analysis becomes available approximately 1 hour and 30 minutes after these synoptic times.

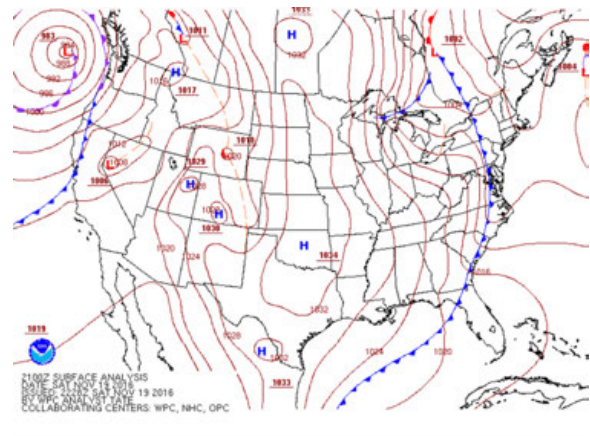

Today's Forecast - The Weather Prediction Center (WPC) National Forecast Chart provides an overview of expected weather for today, with emphasis on certain hazardous and significant weather. They summarize forecasts from several of the National Centers for Environmental Prediction (NCEP) Service Centers including the Storm Prediction Center (for severe thunderstorm and tornado outlooks), the National Hurricane Center (for tropical storm and hurricane forecasts), and the Weather Prediction Center (for information concerning heavy rainfall, flooding, winter weather, and general weather). With overlaid frontal forecasts, these displays serve as a good overview of the expected weather for today.

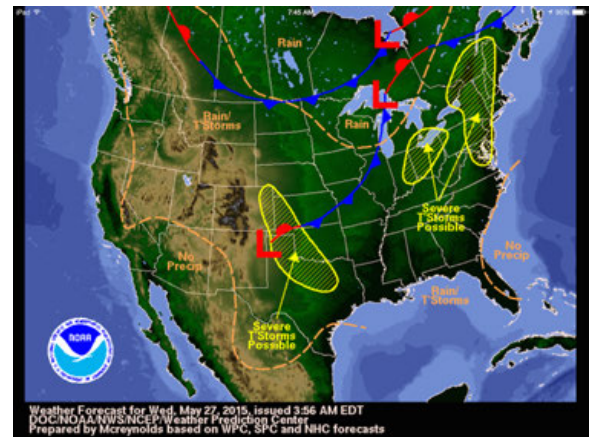

CONUS WEATHER

Prog Charts - The Prog Chart collection contains the latest surface analysis chart which is updated once every three hours. This is not a forecast, but represents the latest surface conditions valid in the recent past. This collection also contains short and extended range forecasts that are also known as "prog" charts. Short range forecasts are updated at various times throughout the day as labeled below each thumbnail image.

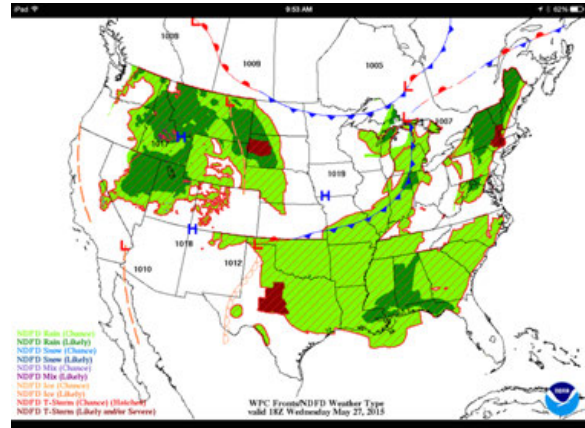

The primary goal of the short range forecasts are to depict the evolution of major weather systems that will affect the conterminous U.S. during the next 60 hours. These forecasts combine the Weather Prediction Center (WPC) forecasts of surface fronts, MSL pressure (isobars) and high/low circulation centers along with a depiction of the expected weather type (precipitation). The precipitation forecast shown on this chart defines expected coverage and is valid at the time on the chart (not over a range of time).

Prog charts use the following colors to depict different weather types (precipitation):

- **Rain (Chance)** - There is chance of measurable rain (≥ 0.01 ") at the valid time.
- **Rain (Likely)** - Measurable rain (≥ 0.01 ") is likely at the valid time.
- **Snow (Chance)** - There is chance of measurable snowfall (≥ 0.01 " liquid equivalent) at the valid time.
- **Snow (Likely)** - Measurable snow (≥ 0.01 " liquid equivalent) is likely at the valid time.
- **Mix (Chance)** - There is a chance of measurable mixed precipitation (≥ 0.01 " liquid equivalent) at the valid time. "Mixed" can refer to precipitation where a combination of rain and snow, rain and sleet, or snow and sleet are forecast.
- **Mix (Likely)** - Measurable mixed precipitation (≥ 0.01 " liquid equivalent) is likely at the valid time. "Mixed" can refer to precipitation where a combination of rain and snow, rain and sleet, or snow and sleet are forecast.
- **Ice (Chance)** - There is a chance of measurable freezing rain (≥ 0.01 ") at the valid time.
- **Ice (Likely)** - Measurable freezing rain (≥ 0.01 ") is likely at the valid time.
- **T-Storm (Chance)** - There is a chance of thunderstorms at the valid time. Areas are displayed with diagonal hatching enclosed in a dark red border.
- **T-Storm (Likely and/or Severe)** - Thunderstorms are likely and/or the potential exists for some storms to reach severe levels at the valid time.

Extended range Progs are also prepared by forecasters at the WPC. A new extended range forecast is issued daily around 0330 UTC and updated again at 1500

and 1900 UTC. Only surface fronts, MSL pressure (isobars) and high/low circulation centers are depicted from 72 hours (Day 3) through 168 hours (Day 7). Each forecast is valid at 1200 UTC. A forecast of instantaneous precipitation is not depicted on extended range Progs.

6 HR Quantity of Precipitation -

Quantitative Precipitation Forecasts, or QPFs, issued by forecasters at the Weather Prediction Center (WPC) depict the amount of liquid precipitation expected to fall in a defined period of time, in this case, six hours. Valid times are shown in the lower left. In the case of snow or ice, QPF represents the amount of liquid that will be measured when the precipitation is melted. It is important to recognize that QPF does not forecast the precipitation type or whether

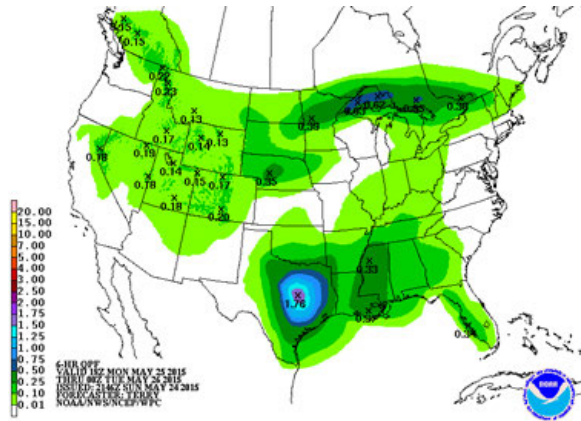

or not the precipitation will be from convection. It is solely used to forecast the amount of precipitation over a given location in inches using solid colored contours based on the legend on the lower left of the chart. An "X" on the chart simply defines a local maximum precipitation amount within a contoured area. Keep in mind that precipitation amounts can vary significantly over short distances, especially when thunderstorms occur, and for this reason QPFs issued by the Weather Prediction Center (WPC) are defined as the expected "areal average."

12 HR Probability of Precipitation -

The Probability of Precipitation (PoP) forecast issued by forecasters at the Weather Prediction Center (WPC) depicts the chances of precipitation over a 12 hour forecast period for the next three to seven days. Probabilities are contoured using solid colors as shown in the legend at the bottom of the chart. Numbers shown on the map represent a probability for a particular city over the valid forecast period. Important: The valid time in the lower left

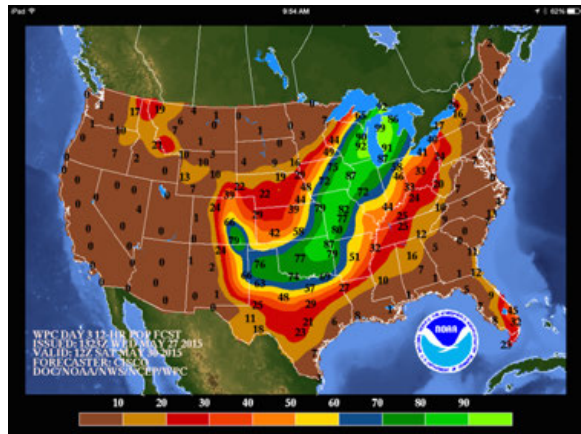

defines the ending time of the 12 hour forecast period. For example, a forecast valid at 00Z on February 13th would include the period from 12Z February 12th to 00Z February 13th.

Outlook (SIGWX) - The low-level SIGWX graphics is a forecast of aviation weather hazards, primarily intended to be used as a guidance product for briefing VFR pilots. The forecast domain covers the conterminous U.S. for altitudes below 24,000 feet (400 mb). These charts are issued four times a day and are valid at 0000 UTC, 0600 UTC, 1200 UTC and 1800 UTC. Each issuance includes both a 12 and 24 hour forecast depicting the freezing levels (dashed cyan), turbulence (dashed orange), and low cloud ceilings and/or restrictions to visibility shown as contoured areas of marginal VFR (blue) and IFR conditions (red). A two-panel chart is also provided that presents the 12 and 24 hour forecasts in the same image.

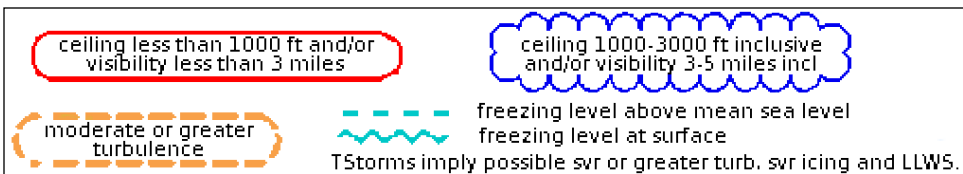

Convective Outlooks - The convective outlooks issued by forecasters at the Storm Prediction Center (SPC) provide an overview of areas that may experience thunderstorms over the next eight days with emphasis on the location of severe convection. Included in this collection are the latest severe thunderstorm (blue) and tornado (red) watch areas along with categorical and probabilistic forecasts for Day 1 (today), Day 2 (tomorrow), Day 3 (the day after tomorrow) and a categorical forecast for severe thunderstorms only for Day 4 through Day 8. Colored contours are shown to depict the threat risk of severe thunderstorms as shown in the legend below. Additionally for Day 1, a probabilistic forecast for tornadoes, large and damaging hail and strong and gusty winds is included.

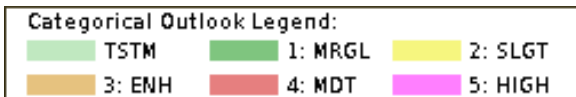
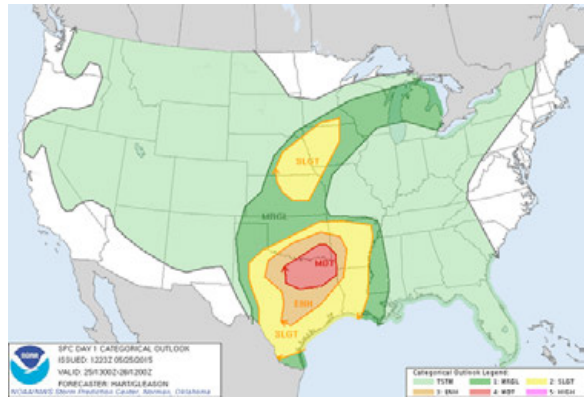

Convective Forecast - The Collaborative Decision Making (CDM) Convective Forecast Planning (CCFP) guidance is a graphical representation of convection meeting specific criteria of coverage, intensity, echo height, and confidence. CCFP graphics are produced every two hours and is valid at 2-, 4-, 6-, and 8-hours after issuance time. This forecast is generated automatically and does not use the same criteria as is used for issuing convective SIGMETs. Hatched contours include sparse coverage-low confidence, sparse coverage-high confidence and medium coverage-high confidence. A forecast for echo tops is also included. Keep in mind this is not a maximum tops forecast. This is best used for strategic planning purposes for aircraft making longer flights at altitudes above FL250.

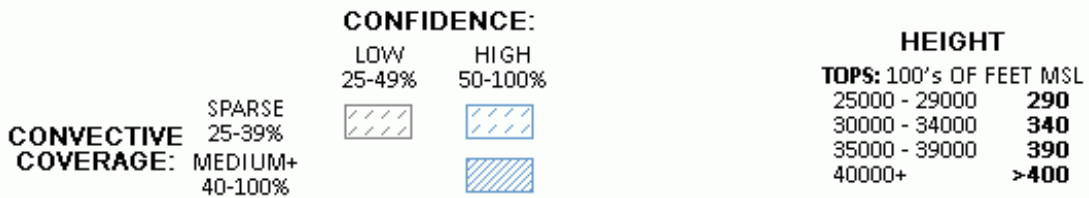
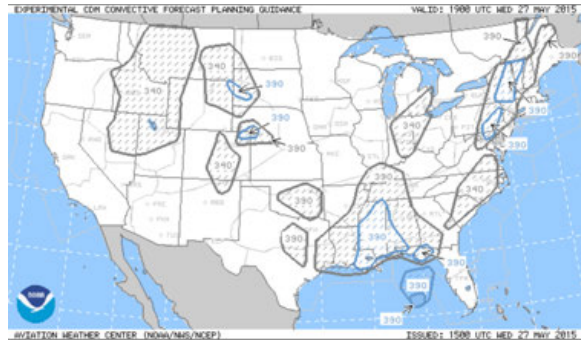

Extended Convective Forecast- The Extended CDM Convective Forecast Planning (CCFP) planning tool is a graphical representation of the forecast probability of thunderstorms. This forecast is automatically generated and identifies where thunderstorms are likely over the next 78 hours. It is important to note that this is not a precipitation forecast. Areas outside of the shaded contours could contain areas of precipitation that are not as likely to be convective. Contours are shaded on based on convective probability as shown in the legend below.

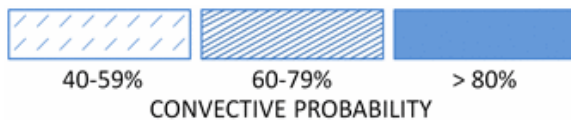

GFS MOS

GFS MOS Ceiling Forecast - Provides a categorical forecast for cloud base heights that are expected to be overcast or broken based on a forecast from the Global Forecast System (GFS) Model Output Statistics (MOS). Categories shown are very low IFR (brown), low IFR (dark yellow), IFR (bright yellow), marginal VFR (bright green), VFR (medium and dark green) and clear below 12,000 feet (black). Forecasts are provided at three hour intervals out to 84 hours.

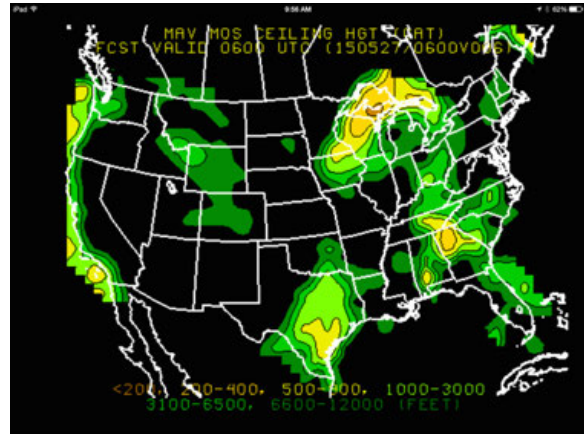

GFS MOS Visibility Forecast - Provides a categorical forecast for prevailing ground visibility based on a forecast from the Global Forecast System (GFS) Model Output Statistics (MOS). Categories shown are very low IFR (brown), low IFR (dark yellow), IFR (bright yellow and bright green), marginal VFR (medium green), six statute miles (dark green) and greater than six statute miles (black). Forecasts are provided at three hour intervals out to 84 hours.

ADVISORIES

Graphical AIRMETs - Also known as G-AIRMETs, Graphical AIRMETs provide a graphical representation of en route advisories for adverse weather including IFR conditions and mountain obscuration, turbulence, icing and freezing level. Graphical AIRMETs are issued by the same forecasters at the Aviation Weather Center (AWC) that issue the legacy AIRMET and Area Forecast (FA). Forecasts are issued four times daily at 0245Z, 0845Z, 1445Z and 2045Z. Graphical are amended as necessary. Unlike the legacy AIRMET that is valid over a six hour period with a six hour outlook, the Graphical AIRMET consists of five snapshots valid at three hour intervals out to twelve hours. The first three Graphical AIRMET snapshots including the Initial, 3 HR and 6 HR make up the same area as included in the legacy AIRMET.

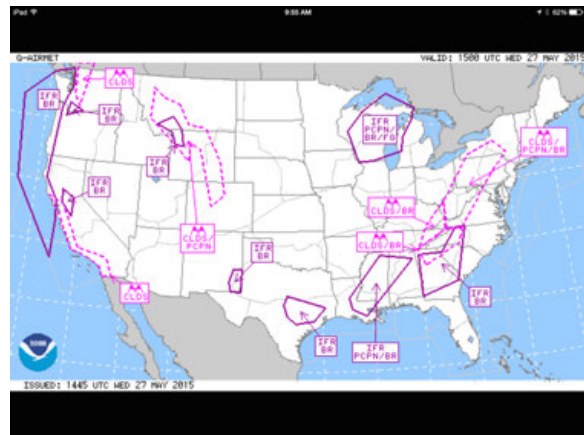

SIGMETs - These en route advisories are issued on an as-needed basis by forecasters at the Aviation Weather Center (AWC). They include advisories for convection, non-convective severe or extreme turbulence, non-convective severe icing, dust storms and sandstorms lowering visibility to below 3 miles and volcanic ash. When issued, these advisories are valid for a four hour period.



WINDS ALOFT

The winds aloft section provides two-dimensional graphics of winds at a multitude of altitudes from the initial time (analysis) with a lead time out to 48 hours. Standard wind barbs (direction and speed) are shown on each chart with the highest winds color contoured in knots using the legend at the bottom of the chart.

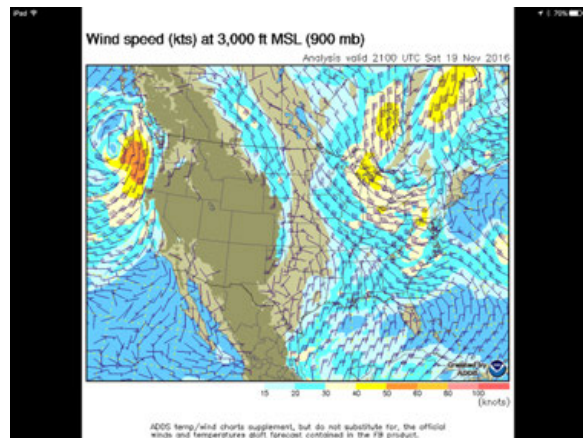

ICING

Lowest Freezing Level - Updated hourly, this includes both an analysis and forecast of the height of the lowest freezing level through the next 18 hours. The lowest freezing level is depicted at 2,000 ft increments in hundreds of feet above mean sea level (MSL) using the color scale at the bottom of the chart. Areas depicted in white consist of regions where the entire temperature profile above the surface is below 0 degrees Celsius. Hatched or stippled areas imply there are multiple freezing levels with the color presented in the hatched areas being the lowest of the multiple freezing levels.

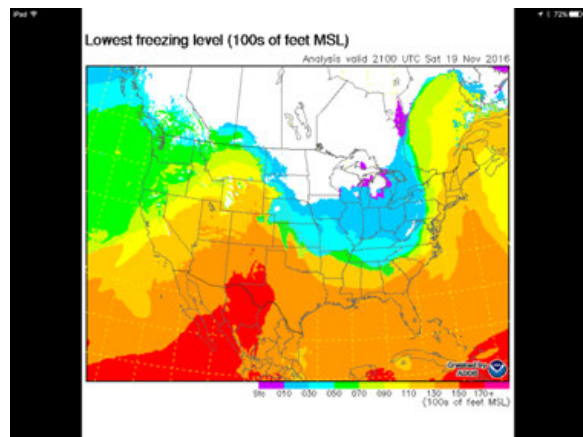

Icing Probability Analysis (CIP) - The Current Icing Product (CIP) combines a Rapid Refresh model forecast with the latest surface observations, visible and IR satellite, NEXRAD, lightning as well as pilot icing weather reports to describe an hourly, three-dimensional analysis of the icing environment using a calibrated probability. Probabilities are shown as percentages using the scale below. A new CIP analysis is generated hourly every 2,000 feet for altitudes from 1,000 feet MSL to FL290. Also a Maximum Icing Probability analysis is provided that is a composite of the maximum probability of all altitudes up to and including FL300. The hourly analysis becomes available about 20 minutes past each hour. Note that this is not a forecast, but a peek in to the recent past.

Maximum icing probability (1000 ft. MSL to FL300)

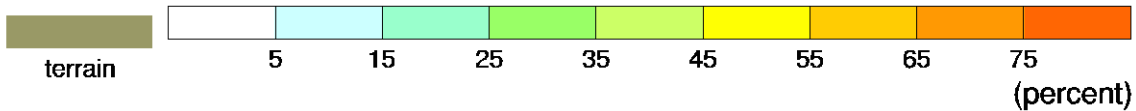
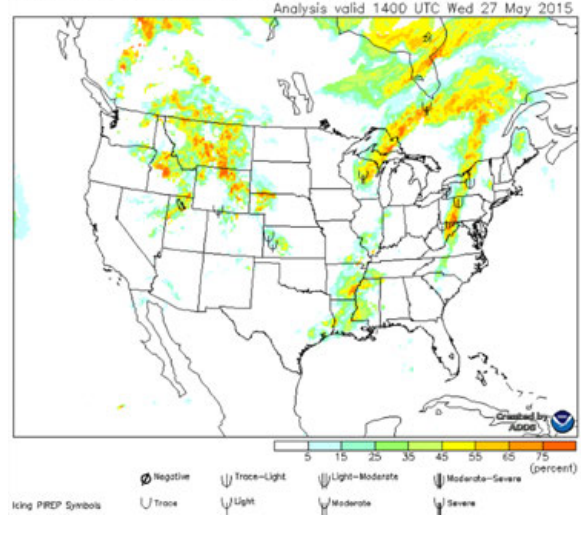

Icing Severity Analysis (CIP) - The Current Icing Product (CIP) combines a Rapid Refresh model forecast with the latest surface observations, visible and IR satellite, NEXRAD, lightning as well as pilot icing weather reports to describe an hourly, three-dimensional analysis of the icing environment using icing intensities. CIP Severity encompasses five categories represented by shades of blue to include trace, light, moderate and heavy as shown in the legend below. Additionally, overlaid on the severity chart is an analysis of the Supercooled Large Drop (SLD) potential shown in red hatching. A new CIP analysis is generated hourly every 2,000 feet for altitudes from 1,000 feet MSL to FL290. Also a Maximum Icing Severity analysis is provided that is a composite of the maximum intensity for all altitudes up to and including FL300. The hourly analysis becomes

Icing severity at 15000 ft. MSL

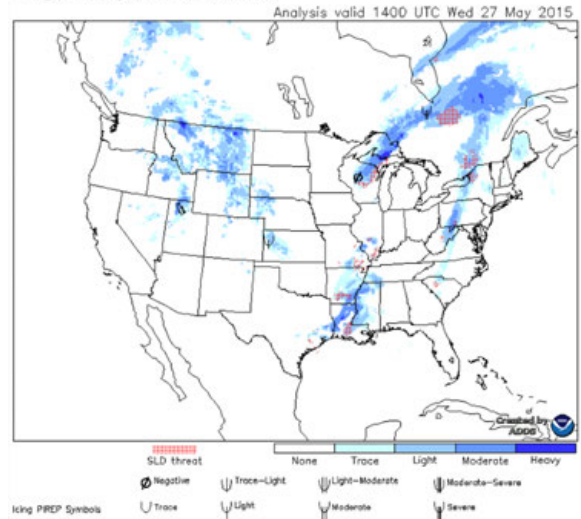

available about 20 minutes past each hour. Note that this is not a forecast, but a peek in to the recent past.

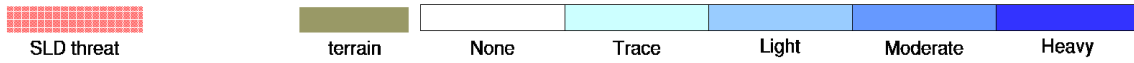

Masked Icing Severity > 25% (CIP) - The Current Icing Product (CIP) masked severity combines the CIP Probability and CIP Severity analyses. Shown in shades of blue are icing intensities with probabilities greater than 25 percent. Icing intensities in areas with less than or equal to 25 percent probability are masked and show up as light gray as shown in the legend below. This allows pilots to visualize the intensities for the icing environment with the highest probability. Note that Supercooled Large Drop (SLD) potential is not shown on this analysis.

Icing severity (prob>25%) at 15000 ft. MSL
Analysis valid 2200 UTC Wed 03 Jun 2015

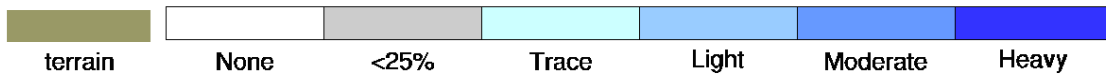
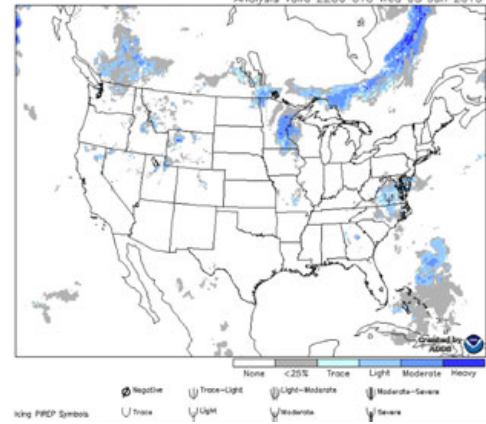

Masked Icing Severity > 50% (CIP) - The Current Icing Product (CIP) masked severity combines the CIP Probability and CIP Severity analyses. Shown in shades of blue are icing intensities with probabilities greater than 50 percent. Icing intensities in areas with less than or equal to 50 percent probability are masked and show up as light gray as shown in the legend below. Note that Supercooled Large Drop (SLD) potential is not shown on this analysis.

Icing severity (prob>50%) at 15000 ft. MSL
Analysis valid 2200 UTC Wed 03 Jun 2015

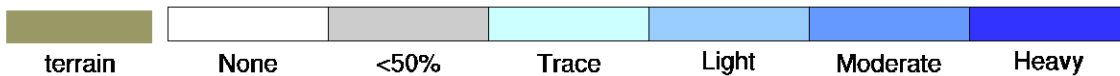
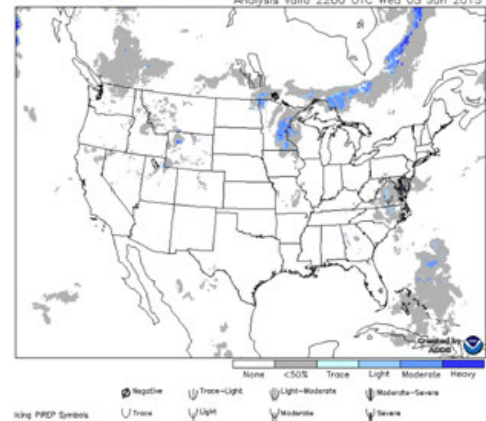

2, 3 and 6 HR Icing Severity Forecast -

The Forecast Icing Product (FIP) uses the Rapid Refresh model forecast to describe a three-dimensional forecast of the icing environment using icing intensities. FIP Severity encompasses five categories represented by shades of blue to include trace, light, moderate and heavy as shown in the legend below. Additionally, overlaid on the severity chart is a forecast of the Supercooled Large Drop (SLD) potential shown in red hatching. Forecasts are provide for 2, 3 and 6 hours.

Icing severity at 13000 ft. MSL

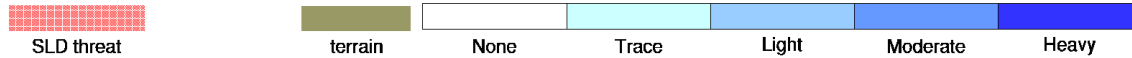
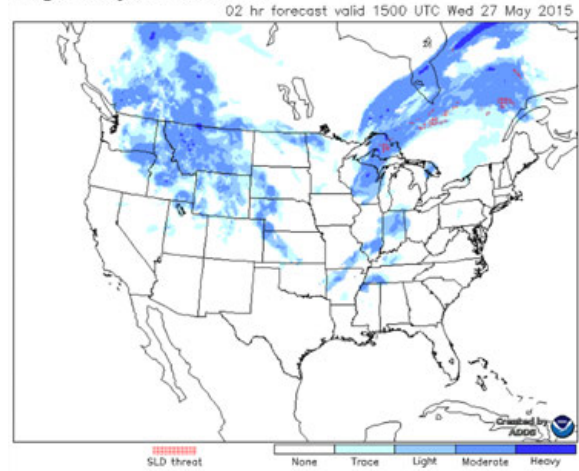

TURBULENCE

Graphical Turbulence Guidance - The Graphical Turbulence Guidance (GTG-3) includes an analysis and forecast for both clear air turbulence (CAT) and mountain wave turbulence (MTW), as well as an (All) section that combines them, with a new forecast updated every hour. The GTG includes turbulence from 1,000' to FL450 with a vertical resolution of 2,000'. Turbulence is measured in eddy dissipation rate (EDR), which is an objective measure of atmospheric energy dissipation, with larger numbers indicating a more turbulent atmosphere.

GTG - Max clear air turbulence (1000 ft. MSL to FL500)

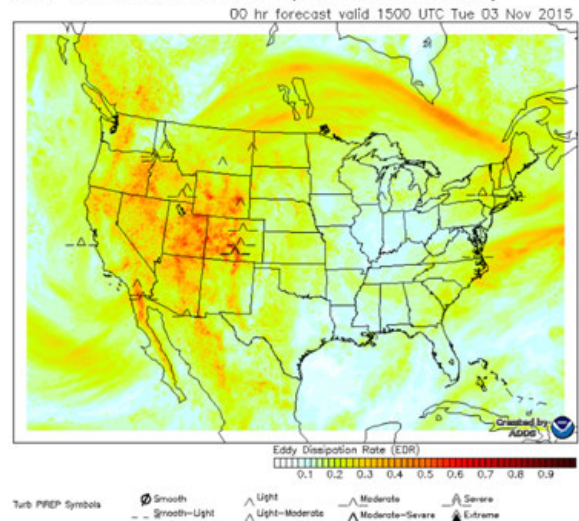

Eddy Dissipation Rate (EDR)

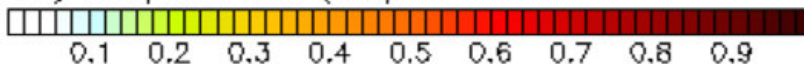

SATELLITE

Visible - The satellite imagery contains national and regional satellite images from the GOES-15 (West) and GOES-13 (East) satellites. These images are updated every 15 minutes. On the visible images clouds and snow appear bright white, but oceans, lakes and trees are much dimmer. After the sun has set and before the sun has risen, these images will be totally black leaving just the geopolitical boundaries.

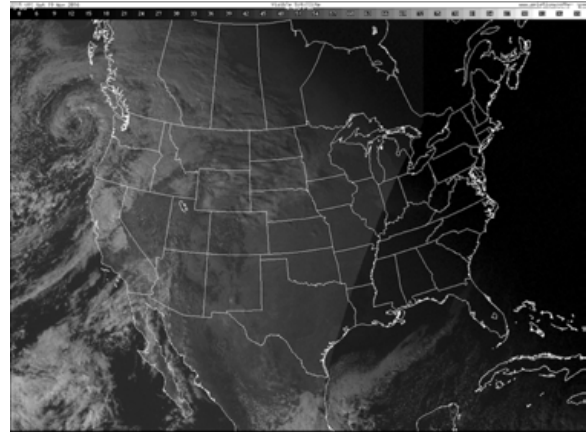

Infrared - The infrared satellite is a colorized depiction of temperature in degrees Celsius and is available during both the daytime and nighttime hours. The data measured by the satellite are calibrated and colorized according to this temperature with red shades representing warmer temperatures and blue shades representing cooler temperatures. Typically the temperature of the atmosphere decreases with increasing height. Therefore, using this depiction can give you an idea of which clouds are high-level and which are low-level based on the cloud top temperature. Keep in mind that with low-topped clouds near the surface, the temperature of the cloud tops can be actually a warmer than the temperature of the surface. Therefore, this depicts the temperature of the surface of the earth during clear skies or the temperature of the cloud tops.

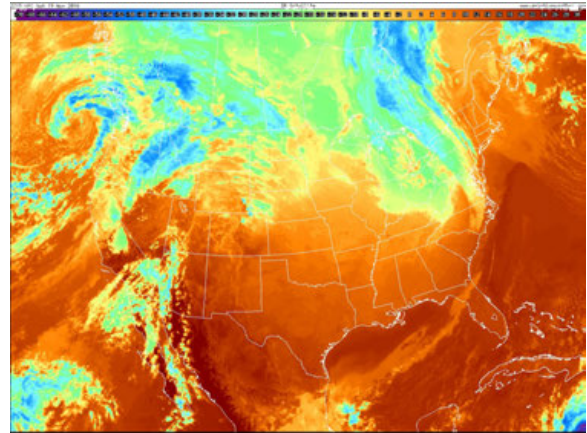

Additionally, cloud top temperatures of -15 degrees Celsius and warmer are typically dominated by liquid water. So temperatures that are in the range of yellow, pale green and sometimes light blue imply the potential for supercooled liquid water to exist in the clouds below, representing a significant airframe icing hazard.

DOPPLER RADAR

The Doppler radar static images and loops are regional/sector depictions of the national NEXRAD mosaic built from the lowest elevation angle base reflectivity data. Looped images are 10 minutes apart over the most recent one hour period. The reflectivity presented on these images has limited filtering to remove non-precipitation returns. As a result, during the early morning and overnight hours, it is quite common to see a significant amount of ground clutter and anomalous propagation depicted on these images and loops.



Also included is the national radar summary chart. This chart is created from what is called the Radar Coded Messages (RCMs). The RCM reflectivity data has spatial resolution of about 12 km and is updated every 30 minutes. The numbers on this image represent the maximum tops for each radar's area of coverage. Please note that some of the tops reported on this graphic are often erroneous.

PILOT WEATHER REPORTS

This includes the most recent pilot weather reports (PIREPs) of icing, turbulence and sky and weather over the conterminous U.S. using standard symbology. National and regional views are available for each of these three pilot weather report categories.

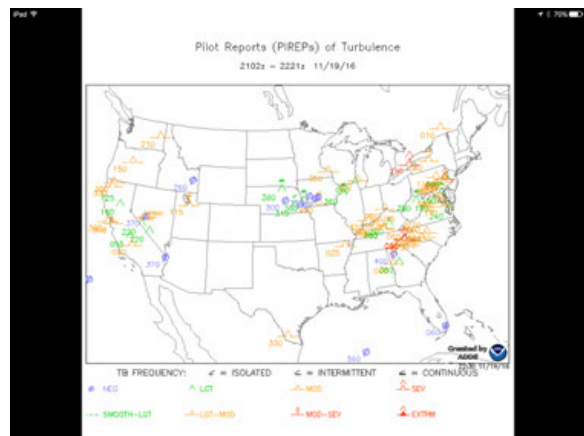

Viewing an Image

View a image full screen by tapping on its thumbnail. View a list of recently-viewed images by tapping the **Recents** button . The full screen view supports all the standard zoom and pan gestures, as well as rotation.

Dismiss the full screen image by tapping the **Close** button at the top left.

Tap the star at the top right to add the current image as a favorite. 

Using Favorite Images

View all favorite images by tapping the double star  button in the dark blue tool bar above the thumbnail images area.

Tap an image in the list to view it full screen.

The favorites list can be re-ordered by tapping the **Edit** button. Once in Edit mode, a three-bar icon is displayed to the right of each image in the list. Tap-and-hold on the three bar icon until the image row appears to lift up, then drag the row to the desired location in the list.

Delete an image from the favorites list using swipe-to-delete. Or, tap the **Edit** button and then the red circle icon beside the image. Then, tap the **Delete** button.

Send To

Tap the Send To button  in the bottom-right corner while viewing an image to save, email, or copy the image to your device's clipboard. Saving the image adds it to your device's Photos app so you can view it offline.

Flights

About the Design

The Flights view replaces the “File & Brief” view and provides a quick way to plan, brief, and file a flight plan. Flight plans can be filed for departures from 10 minutes in the future to days in advance. The top-to-bottom workflow follows a logical progression from inputting airports, selecting an aircraft and performance profile, defining a route and altitude, then filing the flight plan. Plans created on the Flights page can also be sent to the Maps page for graphical review, and routes can still be sent from the Maps page to Flights to create and file a flight plan, and to get a briefing.

ForeFlight customers who have purchased a Performance Plus or Business Performance subscription can also use high-fidelity aircraft performance profiles to quickly and accurately plan their flights including passengers, baggage, and fuel. For more information about the Performance plans, please visit www.foreflight.com, or see the Performance in ForeFlight guide in the [Documents](#) catalog.

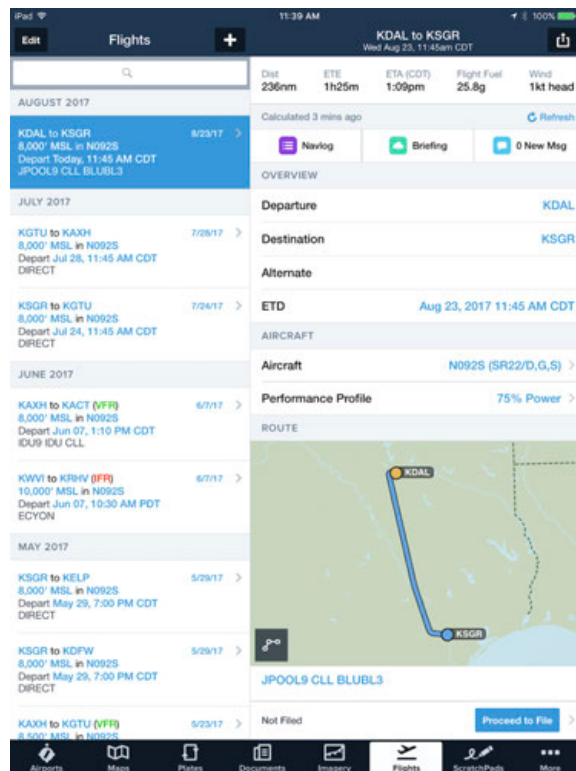

Before Filing a Flight Plan

You can use ForeFlight Mobile to file most flight plans with Leidos or DUATS. Canadian VFR ICAO flight plans are sent directly from ForeFlight to Canadian flight services. Available flight plan types for each service are shown below:

Flight Plan Type	Leidos	DUATS	ForeFlight
FAA/Domestic VFR	YES	YES	NO
FAA/Domestic IFR	YES	YES	NO
FAA/Domestic VFR (DC SFRA)	YES	YES	NO
ICAO VFR in US	YES	NO	NO
ICAO IFR in US	YES	NO	NO
ICAO VFR (DC SFRA)	YES		
ICAO IFR in Canada, Mexico, & to/ from US	YES	NO	NO
ICAO VFR outside of US, except Canada	YES	NO	NO
ICAO VFR from US to Canada	YES	NO	NO
ICAO VFR from Canada to US	NO	NO	YES
ICAO VFR in Canada	NO	NO	YES

To file a flight plan with Leidos, [sign out of your DUATS account](#) on the **More > Accounts** page. NOTE: All non-Canadian ICAO flight plans are filed directly with Leidos even if you have entered DUATS credentials.

The following actions are available on the Flights page in ForeFlight Mobile when filing a flight plan with Leidos:

	Flight plan type (filing with Leidos)		
Action	IFR - Filed	VFR - Filed	VFR - Active
File	ETD	ETD	n/a
Amend	ETD -47 minutes	ETD +2 hours*	Until closed*
Cancel	ETD -47 minutes	ETD +2 hours	n/a
Activate	n/a	ETD +2 hours	n/a
Close	n/a	n/a	Until closed

* ETD cannot be changed. If the ETA needs to be changed, amend the ETE.

IMPORTANT: VFR Flight Plans are only used for Search & Rescue purposes and are **not** sent to Air Traffic Control.

Flight plans can be filed with Leidos up to 27 days prior to departure. Flight plans filed with Leidos are released to ATC approximately 3 hours prior to your ETD.

Flight plans filed with DUATS can be filed up to 24 hours prior to departure. Flight plans filed with DUATS cannot be Activated, Closed, Amended or Cancelled inside of ForeFlight Mobile. However if your flight departs more than 2 hours in the future, you can sign-in to your DUATS account at www.duats.com to Amend or Cancel the plan.

NOTE: As of October 2014, pilots calling Flight Service to activate a VFR flight plan filed using ForeFlight (as well as other electronic tools) may still be asked for their pilot information, even though that information was transmitted by ForeFlight when the plan was filed. This may be especially prevalent for VFR flight plans filed in Alaska.

Choosing between FAA/Domestic and ICAO Flight Plans

The FAA has announced that all FAA/Domestic flight plans will transition to ICAO flight plans in the Fall of 2017. Until then, pilots are recommend to begin filing ICAO flight plans as soon as possible to ensure a smooth transition. Until the mandated transition, ICAO flight plans are only required when:

- 1) The flight will enter international airspace, including Oceanic airspace controlled by FAA facilities.
- 2) The flight expects routing or separation based on Performance Based Navigation (PBN), e.g., RNAV SIDs and STARs

3) The flight will enter Reduced Vertical Separation Minima (RVSM) airspace, e.g., FL290 or above.

4) The flight expects services based on ADS-B.

Flights that remain wholly within domestic United States airspace and do not meet any of the 4 criteria listed above may still use a FAA/Domestic flight plan.

Creating a Flight Plan

Create a flight plan by tapping “Proceed to Filing” after planning a flight as discussed in the [Planning a Flight](#) section of this guide.

You can add a call sign to your flight plan by entering it in the *Call Sign (Optional)* field. When a flight plan is filed under a call sign, the call sign is transmitted to ATC in place of the aircraft’s tail number, and the tail number is copied to the flight plan’s remarks so as to be available to ATC. If no call sign is entered the flight plan will be filed under the aircraft’s tail number.

When *VFR (DC SFRA)* is selected, you need to provide an appropriate gate for SFRA entry as your departure point (when inbound to the SFRA) or the appropriate exit gate in the destination field (when outbound). Your ETE value should match when you expect to enter the SFRA (when inbound) or exit it (when outbound). If you wish to do non-towered airport pattern work within the SFRA enter + *REQ PTTN* in your remarks.

Creating an ICAO Flight Plan

For details about creating an ICAO flight plan and entering the ICAO-specific aircraft information in **More > Aircraft**, refer to “Filing with ForeFlight” available in the Document catalog under ForeFlight.

Exporting an ICAO Flight Plan

You can generate a formatted PDF of your flight plan in the official ICAO layout by tapping the Send To button in the bottom-left of the filing form and tapping “Export PDF”. Tap the Send To button in the top-right to share the PDF via AirDrop, email, or print. When you tap Close in the top-left you will have the option to save the PDF as a document. If you tap “Yes” it will save the PDF in the Imported tab of the Documents Catalog, allowing you to add the PDF to any binder by tapping on it.

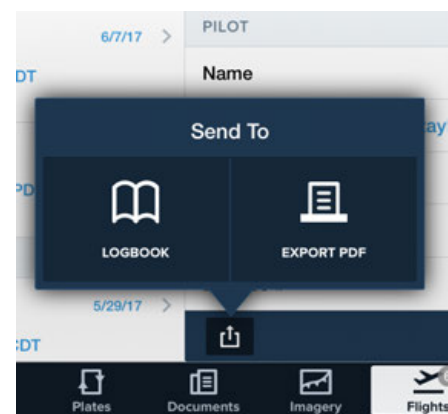

Obtaining a Weather Briefing

The recommend default is to obtain a graphical [ForeFlight Briefing](#) by tapping the “Briefing” button.

Sections of the briefing listed in bold have content for you to review; plain sections are empty. Once you have selected a section, you can use the left and right arrows at the top right to skip to the previous or next section, respectively.

Tapping the top left button (labeled with the origin and destination) takes you back to the briefing section list. Tap **Flights** at the top left to return to the flight plan form.

Briefings are stored on the iPad. To show a previous briefing, tap the **Briefing** button again when viewing the previously briefed flight plan.

Existing briefings can be refreshed to show the latest data. Select the desired plan form from the list at the left, tap the **Brief** button at the bottom center, then tap the **Refresh** button at the bottom left of the briefing to request an updated briefing.

Briefings can only be obtained or refreshed when an active network connection is available.

Filing your Flight Plan (FAA/Domestic or ICAO)

Once your flight plan form is complete, you can file it using the **File** button at the bottom right of the form and confirming the action by pressing the **File** button on the pop-up. An active ForeFlight subscription is required to file a flight plan.

The flight plan will either be accepted and you will be notified of a successful file, or it will be rejected and ForeFlight Mobile will identify the error reported by Leidos or DUATS. If rejected, you can correct the error and re-file.

Once a flight plan has been filed, it will no longer be editable, but it can be Amended. To create a new flight plan form from the filed plan, tap the **Send To** button  and choose **Copy**.

Flight Plan Acknowledgment Notification

After you file your flight plan with Leidos you should receive two notifications by email and push notification directly to your device. First that device will receive a

“Filing Succeeded” message, indicating that the plan was successfully filed with Leidos.

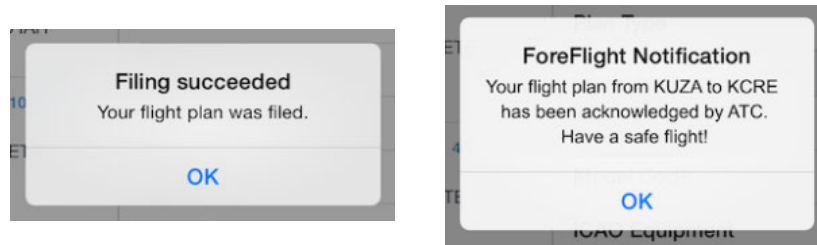

After Leidos transmits the plan to ATC (at ETD -3 hours, or immediately if your ETD is within 3 hours) and ATC acknowledges receipt of the plan, that device will receive a “ForeFlight Notification.”

Under certain circumstances ForeFlight may not receive the ATC notification from Leidos; in that case, the device that filed the plan will receive a message, “ForeFlight has not yet received a notification from Flight Services indicating that ATC has acknowledged your upcoming flight from KXXX to KZZZ (N9999). Please contact Flight Services at 1-800-WX-BRIEF to check the status of your flight plan.”

Flight Notifications

After filing your flight plan via Leidos, two hours prior to your scheduled departure time ForeFlight will begin monitoring your route of flight and providing weather and other alerts relevant to your filed flight plans. You must have an active internet connection to receive these alerts and [Sync](#) must be enabled for your account.

ForeFlight notifies you if there are updates to: TFRs, airport/runway closed/unsafe NOTAMs, urgent PIREPs, SIGMETs, Convective SIGMETs, AIRMETs, Center Weather Advisories (CWAs), and Severe Weather Watches/Warnings that affect your filed route.

Once you file a flight plan, ForeFlight will notify you of any new conditions via a red badge (showing the number of Notifications) on the Flights tab, and via text on the Flight plan listing on the left side of the Flights page.

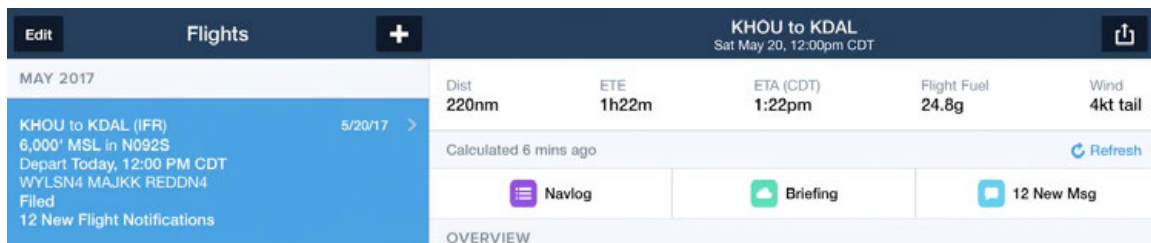

Select the Flight Plan in the left column, then tap the “# New Msg” button at the top of the flight plan to view a summary of the alerts. A thumbnail of each alert’s graphic is shown to the left of the alert.

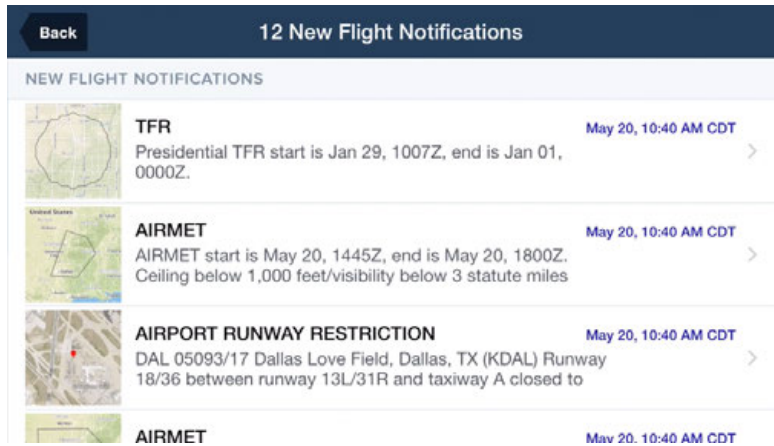

Tap an individual alert to view all details, including the full-size graphic. Tap the “Next” or “Prev” button to move through the list.

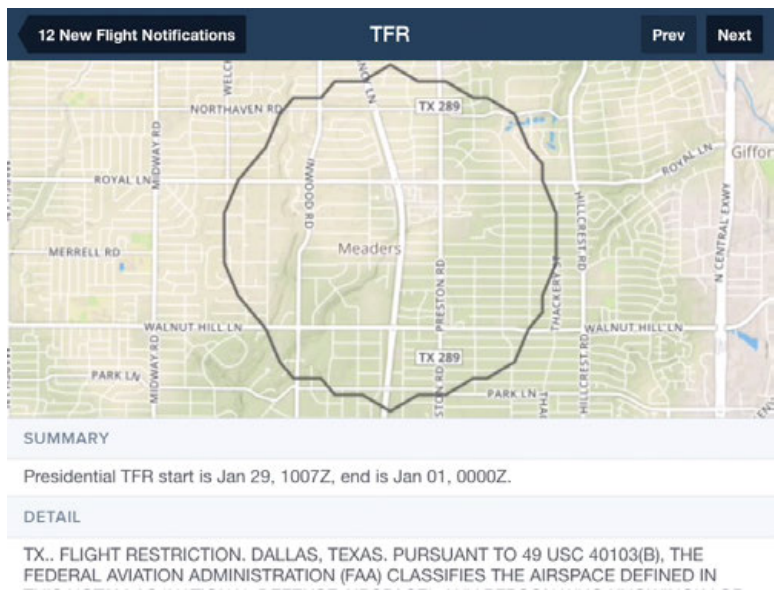

Amending or Canceling a Leidos Flight Plan

After you have filed a flight plan with Leidos, tap the “Amend” button at the bottom of the Flights page to make changes to the plan.

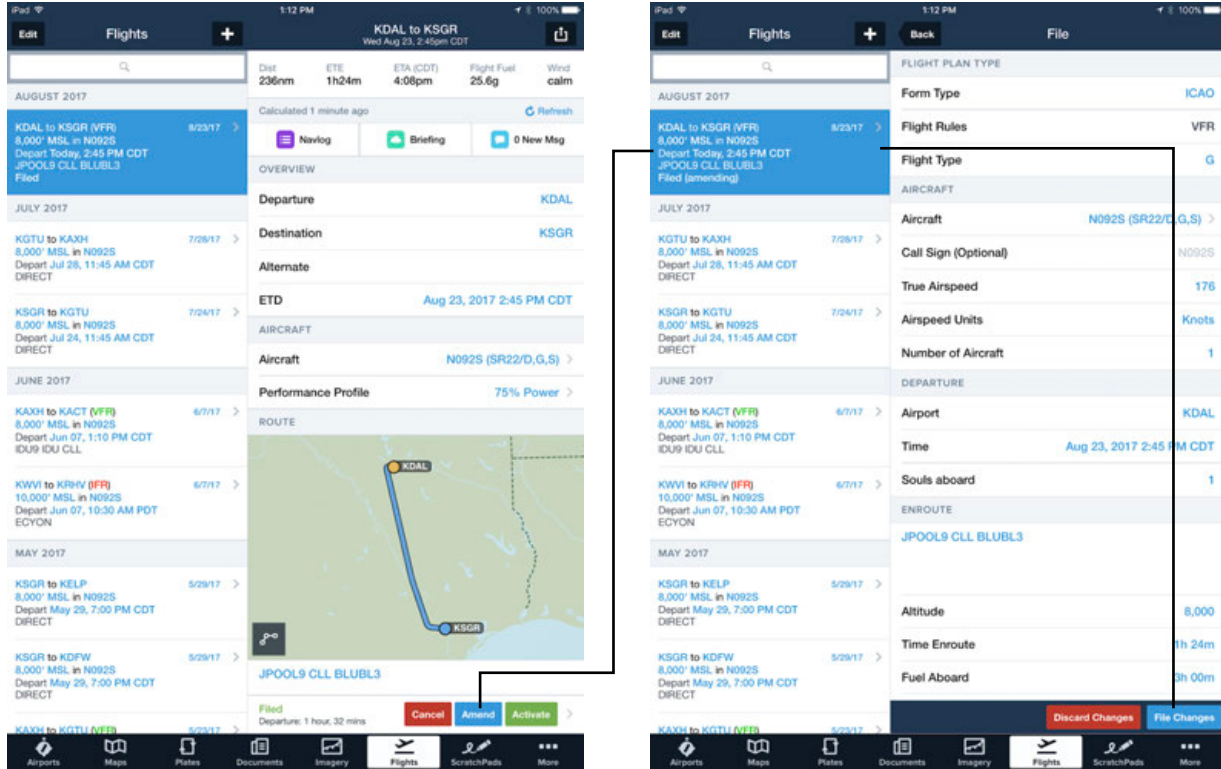

Once you have made your changes, tap the “File Changes” button to file the amended plan, or tap “Discard Changes” if you don’t want to make changes to the plan.

To cancel a plan, tap the red “Cancel” button.

IFR flight plans can be amended or canceled until 30 minutes **before** the filed ETD. VFR flight plans can be amended or cancelled up to 2 hours **after** the filed ETD.

Activating or Closing a Leidos VFR Flight Plan

Once you have filed a VFR flight plan with Leidos and you are ready to depart, tap the “Activate” button on the Flights page to view the confirmation dialog. This lets you know the departure time that will be logged with Flight Services, as well as your ETA based on your ETE and the activation time.

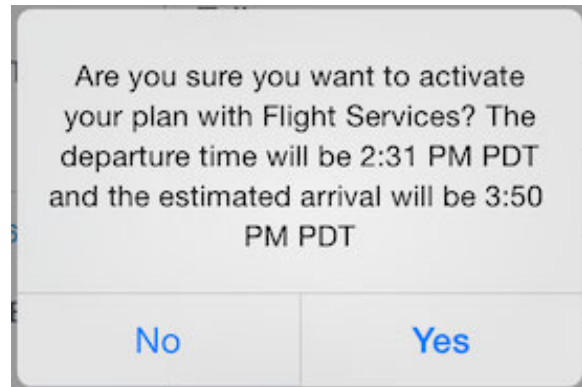
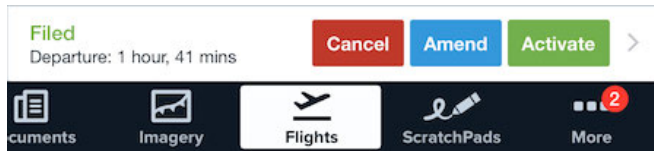

To activate the flight plan directly with Leidos, which is equivalent to calling Flight Service to activate a VFR plan, tap “Yes.”

VFR flight plans must be activated within 2 hours of the filed ETD. If it is more than 2 hours after the filed ETD, you must re-file the flight plan with a revised ETD.

After your VFR plan is activated, the “Close” button will be displayed for that plan. Active VFR plans can only be closed in ForeFlight Mobile if 1) the plan was Filed **and** Activated using ForeFlight Mobile, and 2) your device is connected to the Internet.

VFR FLIGHT PLANS IMPORTANT INFORMATION:

ForeFlight will **never** activate or close a VFR flight plan for you. If you have not personally activated a flight plan **and received an acknowledgement** either in ForeFlight or by calling Flight Service then your flight plan will not be activated and SAR services will not be available for your flight. If you activated a VFR flight plan by calling Flight Service then you **must** call Flight Service to close the plan; you **cannot** close a flight plan in ForeFlight that was not activated in ForeFlight.

Activating or closing a VFR flight plan in ForeFlight requires an active internet connection, either over Wi-Fi or cellular. If an internet connection is not available, the Activate and Close buttons will not appear. If you are connected to a Stratus or other inflight Wi-Fi device, **you will not have internet connectivity in ForeFlight**, even if you also have a good cellular connection. You **must** turn off your device’s Wi-Fi (or disconnect from the inflight Wi-Fi device) to activate or close a flight plan - swiping up from the bottom of the screen to access your device’s Control Center is the easiest way to do this.

If you have filed and activated a cross-border VFR flight plan (e.g. from the U.S to Canada) you **must** close the flight plan directly by calling the destination country’s flight service (NavCanada in Canada, FSS in the U.S.), **not** by closing the flight plan in ForeFlight. **Failure to close the flight plan with the destination country may result in Search and Rescue being initiated.**

An easy way to determine the status of your flight plan if using ForeFlight to activate and close (**not** if calling Flight Service) is to look at the bar at the bottom of the Flights view. The flight plan's status appears on the left.

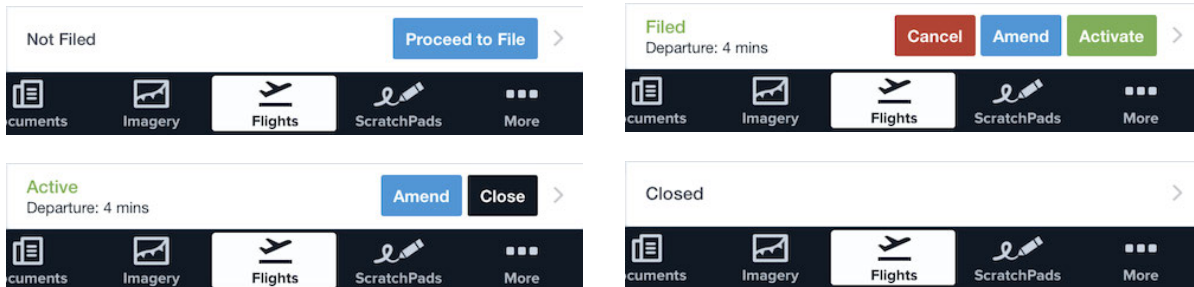

Close VFR Flight Plan “PUSH” Alerts

If you activated a VFR flight plan using ForeFlight Mobile and have not closed the plan 20 minutes after your calculated ETA (Departure time + ETE), ForeFlight will send a “push” notification to your devices reminding you to close your flight plan. You can close the plan using the “Close” button on the Flights page, or by calling 1-800-WX-BRIEF.

If the plan still has not been closed 30 minutes after your calculated ETA (Departure time + ETA) Leidos will send ForeFlight an “OVERDUE” status update, and ForeFlight will then send another “push” notification to your devices reminding you to close your flight plan immediately.

Amending or Canceling a DUATS Flight Plan

Once a DUATS flight plan has been filed using ForeFlight Mobile, it **cannot** be Amended, Cancelled or Closed using ForeFlight Mobile. However if you have entered your own DUATS sign-in credentials in ForeFlight Mobile at **More** > **Accounts** AND the flight departs in more than 2 hours, you can modify or cancel the flight plan by signing-in to your DUATS account at www.duats.com.

Managing Flight Plans

When viewing the listing of flight plan, you may wish to remove some to keep the length of the list under control. To remove a flight plan, swipe your finger from right to left across the entry, then tap the red “Delete” button. You can also tap the red “Delete” button at the bottom of an entry and confirm to delete it. This will not close or cancel a filed plan, but will remove its details from ForeFlight Mobile.

Flight Alerts

Flight Alerts notify you when ATC issues an expected route for an IFR flight plan filed using ForeFlight Mobile.

When updated expected route information becomes available from ATC, ForeFlight's servers send a notification of that route information directly to your devices, as well as sending an email with the route information. ForeFlight also sends you a message if our servers do not receive an expected route for your flight from ATC.



NOTE: if you are a member of a multi-pilot account, the notification is sent only to the device that filed the flight plan.

Swipe Down to display

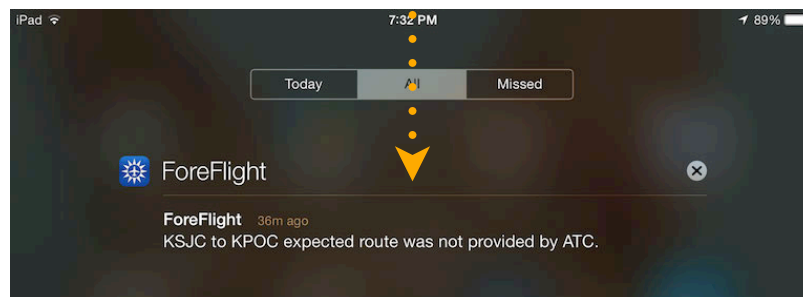

You can also view Expected Route Flight Alerts in the iOS Notification Center, which is accessed by swiping down from very top of the screen with a single finger.

When you tap on the notification or the link in the email, a pop-up containing the expected route appears on the screen. Tap **Yes** to load the route into the Route Editor. When the expected route is loaded, the flight plan form (on Flights) is updated with the expected route and a link to FlightAware for flight tracking.

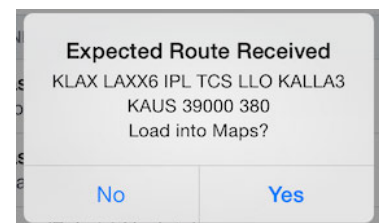

IMPORTANT: ForeFlight cannot parse Expected Routes that do not originate at a Fix (e.g., "Radar Vectors to V17..."). If your Expected Route doesn't originate at a Fix, ForeFlight plots a route "direct-to" the next Fix on the route. The "direct-to" route may differ significantly from the instructions you will be given by ATC. After loading an Expected Route, verify that all legs are displayed correctly and be prepared to follow ATC instructions for legs not originating at a Fix (e.g., "Radar Vectors to V17...")

ForeFlight Briefing

About the Design

ForeFlight Briefing provides a graphical and translated weather briefing in place of the older wall-of-text briefing. The information it presents is the same as the text briefing and comes from the same source (Leidos), but the layout and navigation have been overhauled to improve readability and ease of comprehension. You can enable or disable ForeFlight Briefing in More > Settings > File & Brief.

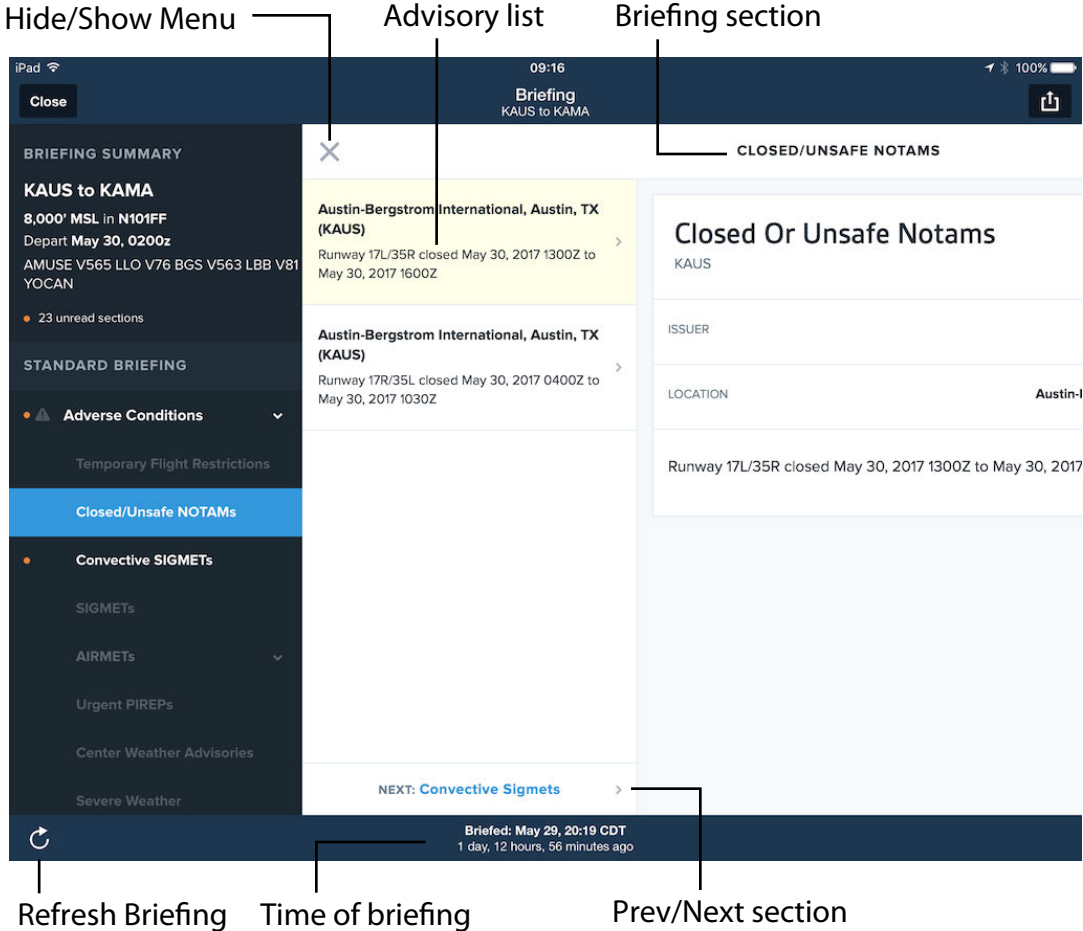

Navigating the Briefing

ForeFlight Briefing is organized into sections that can be accessed by tapping the Menu button in the upper-left corner of the screen, or by swiping right. This opens a sidebar with a summary of the briefing at the top, followed by the list of sections. Sections with a carat next to them contain subsections which can be accessed by tapping the section to expand it. Tapping on a section with no subsections will take you to that page of the briefing. Orange dots indicate that a section (or one of its subsections) has not been viewed. Swipe left or tap the “X” button next to the sidebar to hide the menu.

At the bottom or bottom left of each page is the “Next” button, which shows what the next page in the briefing is. Tap it to move to the next page, or tap the smaller “Back” button to its left to move back one page.

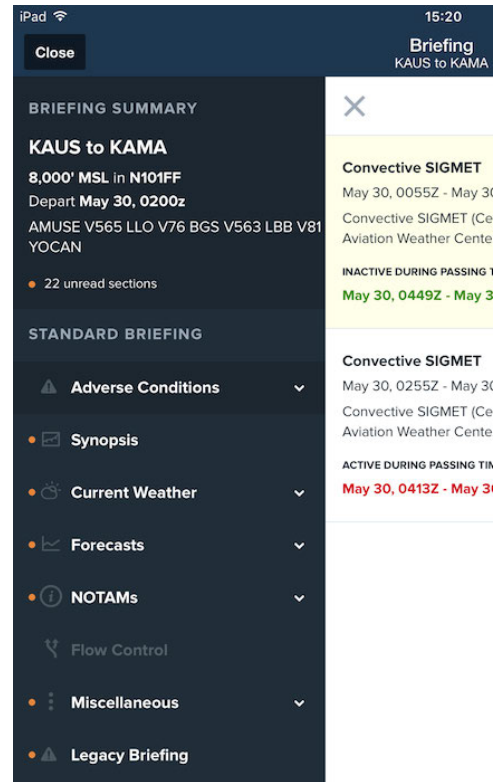

Translated Text vs Raw Text

Most pages in the briefing allow you to view both the raw text of the briefing and the translation of that text. On split-screen pages like those in the Adverse Conditions section or the Synopsis page, you can view the raw text by tapping “Show Raw Text” at the bottom of the right column. On full-screen pages like the METARs, TAFs, or NOTAMs pages, a “Plain Text” slider at the top right of the page allows you to toggle the text between raw and translated. The position of this slider is retained between pages in the same briefing.

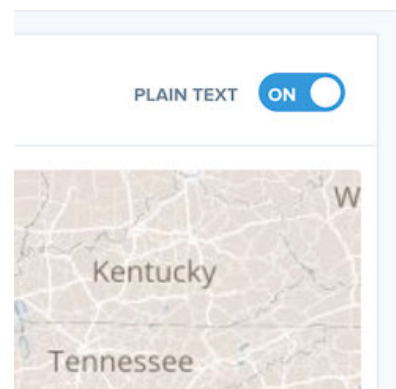

Briefing Sections

Adverse Conditions

The Adverse Conditions section includes important safety advisories such as TFRs, closed/unsafe NOTAMs, and AIRMETs and SIGMETs.

These pages are laid out in a split-screen view: on the left is a list of selectable advisories with basic information about each, and on the right is more detailed information about the selected advisory, including the translated text and a map showing the advisory against your route of flight.

The screenshot displays the 'IFR AIRMETS' interface. On the left, a list of advisories is shown. The top entry is 'Airmet Sierra' with a passing time of 'Nov 11, 0444Z - Nov 11, 0647Z' in red. The second entry is also 'Airmet Sierra' with a passing time of 'Nov 10, 2343Z - Nov 11, 0128Z' in green. On the right, the detailed view for 'Airmet Sierra' is shown. It includes the text 'Airmet Sierra' and 'IFR'. The active time is 'Nov 11, 0300Z - Jan 05, 0000Z'. The inactive time is 'Nov 10, 2343Z - Nov 11, 0128Z'. Below the text is a map of the United States and Mexico. A flight route is shown starting from KSLC in Salt Lake City, Utah, and ending at RHO in Houston, Texas. The route passes through the area of the Airmet Sierra. The map also shows other airports like Chicago, Los Angeles, and Chihuahua.

The time at which the advisory is active is shown at the top, and below that is the time interval during which you will pass the advisory. This interval is color-coded based on how close your passing time is to the time at which the advisory is active: **Green** means the advisory won't be active during or near your passing time, **Orange** means the advisory will be active near your passing time, and **Red** means the advisory will be active during your passing time.

Synopsis

The Synopsis page provides an overview of the weather trends for each geographical area through which your route passes. As with the Adverse Conditions section, you can select each area's forecast from a list on the left, and read the translated text of that forecast on the right. At the top of the right column is the most recent Surface Analysis Chart for the Continental US published by the Hurricane Prediction Center that day.

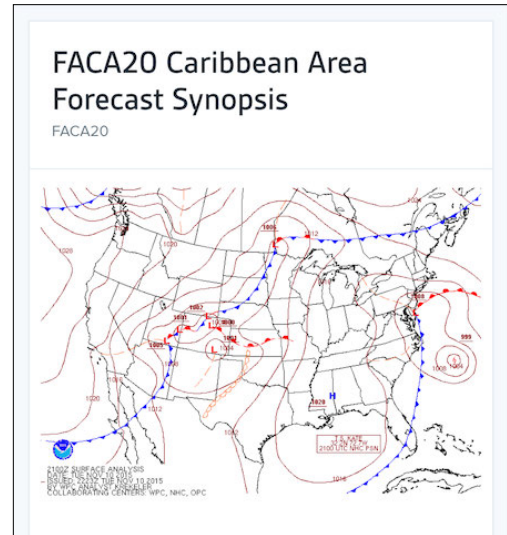

Current Weather

The Current Weather section includes information on current conditions along your route.

The METARs page shows the most recent METARs issued for the airports along your route. At the top of the page is a map showing your route and colored bubbles indicating the flight category at each airport. The [coloring system](#) for the bubbles is the same as what is used in the Flight Category layer on the Maps view.

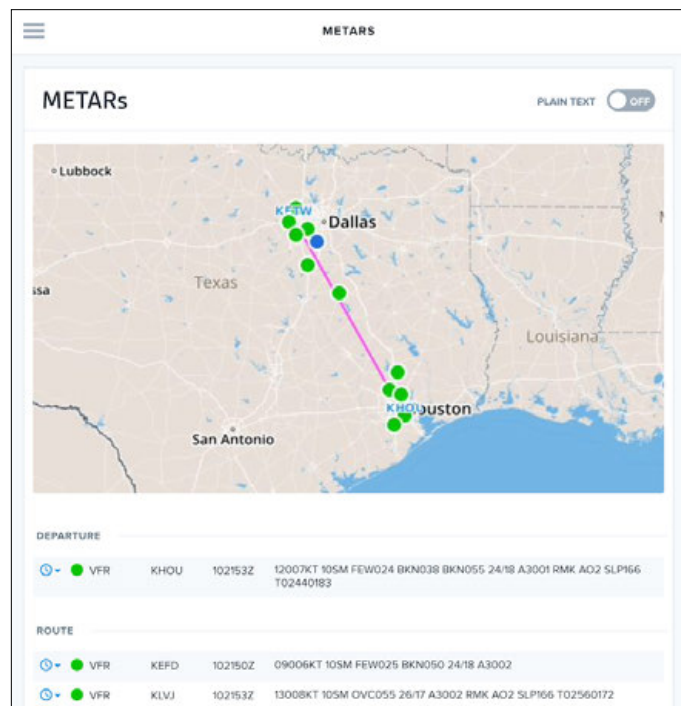

Below the map is the list of current METARs issued for each airport. You can view previous METARs issued for each airport by tapping the clock icons next to each flight condition bubble.

Forecasts

The Forecasts section includes information on forecasted conditions along your route.

The Area Forecasts page is similar to the Synopsis page, but provides forecasted weather trends for each geographical area through which your route passes. It also includes the most recent 6 HR Prog chart at the top of the right column.

The TAFs page displays TAFs for every airport that issues them along your route. Like the METARs page, it includes a map at the top showing your route and flight categories that correspond to the TAFs that will be valid for each airport during your passing time.

Below the map is a list of TAFs that will be valid at or near the time you pass each airport.

Highlighted TAFs will be valid at the time of your passing, which is shown in a box on the left. If a TAF will be valid within an hour of your passing, but not during your passing, the time difference between when that TAF is valid and your time of passing is shown on the left, with an arrow pointing at the TAF. These numbers can be positive or negative. For example, if a new TAF becomes valid 29 minutes after I pass an airport, that time difference is shown next to the TAF, as in the screenshot above. This feature is meant to let you know when weather might take a turn for the worse near your passing time.

2331Z	●	VFR	Easterwood Field, College Station, TX (KCLL). Issued Nov 10, 1726Z, valid from Nov 10, 1800Z until Nov 11, 1800Z, Wind from 160° at 9 knots, greater than 6 statute miles visibility, Scattered Clouds at 3,000 feet, Ceiling is Broken at 5,000 feet
+29min →	●	VFR	From Nov 11, 0000Z, Wind from 150° at 6 knots, greater than 6 statute miles visibility, Scattered Clouds at 2,500 feet, Ceiling is Broken at 4,000 feet
	●	MVFR	Temporary between Nov 11, 0200Z and Nov 11, 0600Z, Ceiling is Broken at 1,500 feet, Broken Clouds at 3,000 feet
	●	MVFR	From Nov 11, 0600Z, Wind from 160° at 9 knots, greater than 6 statute miles visibility, Ceiling is Broken at 1,500 feet, Broken Clouds at 3,000 feet, wind shear surface to 2,000 feet, wind from 230° at 35 knots
	●	MVFR	From Nov 11, 1500Z, Wind from 180° at 10 knots, greater than 6 statute miles visibility, Showers in the Vicinity, Scattered Clouds at 700 feet, Ceiling is Broken at 1,500 feet.
	●	VFR	San Luis Valley Rgnl/Bergman F, Alamosa, CO (KALS). Issued Nov 10, 1727Z, valid from Nov 10, 1800Z until Nov 11, 1800Z, Wind from 180° at 12 knots, greater than 6 statute miles visibility, Sky Clear
	●	VFR	From Nov 10, 2000Z, Wind from 210° at 15 knots with gusts to 25 knots, greater than 6 statute miles visibility, Few clouds at 10,000 feet
0411Z	●	VFR	From Nov 11, 0200Z, Wind from 230° at 15 knots with gusts to 25 knots, greater than 6 statute miles visibility, Showers in the Vicinity, Scattered Clouds at 3,000 feet, Ceiling is Broken at 6,000 feet
	●	VFR	From Nov 11, 1000Z, Wind from 280° at 12 knots with gusts to 22 knots, greater than 6 statute miles visibility, Ceiling is Broken at 8,000 feet
	●	VFR	From Nov 11, 1600Z, Wind from 340° at 12 knots, greater than 6 statute miles visibility, Scattered Clouds at 12,000 feet.

NOTAMs

The NOTAMs section includes all the NOTAMs for your flight, apart from the closed/unsafe NOTAMs, which are found in the Adverse Conditions section.

Nearly all of these pages have the same layout, with a map showing your route at the top and the NOTAMs below. The only exception is the Enroute Obstruction NOTAMs page, which has a table at the top showing the total number of obstructions along your route, and how many of them are within 500 feet, 1000 feet, or beyond 1000 feet of your filed altitude, and how many have an unknown MSL altitude.

Miscellaneous

The Miscellaneous section includes any NHC bulletins that have been issued, as well as a page showing three days of convective outlooks issued by the Storm Prediction Center.

ScratchPads

About the Design

ScratchPad lets you choose from six different Scratch Pad templates to quickly record useful information. Any changes you make to a ScratchPad are automatically Sync'd to any other iPads signed-in to your account (ScratchPads are not currently available on the iPhone).

Open a ScratchPad

Tap the “+” button (upper-right) or “+ NEW SCRATCHPAD” rectangle to open the ScratchPad template chooser, or tap an existing ScratchPad thumbnail to open it.

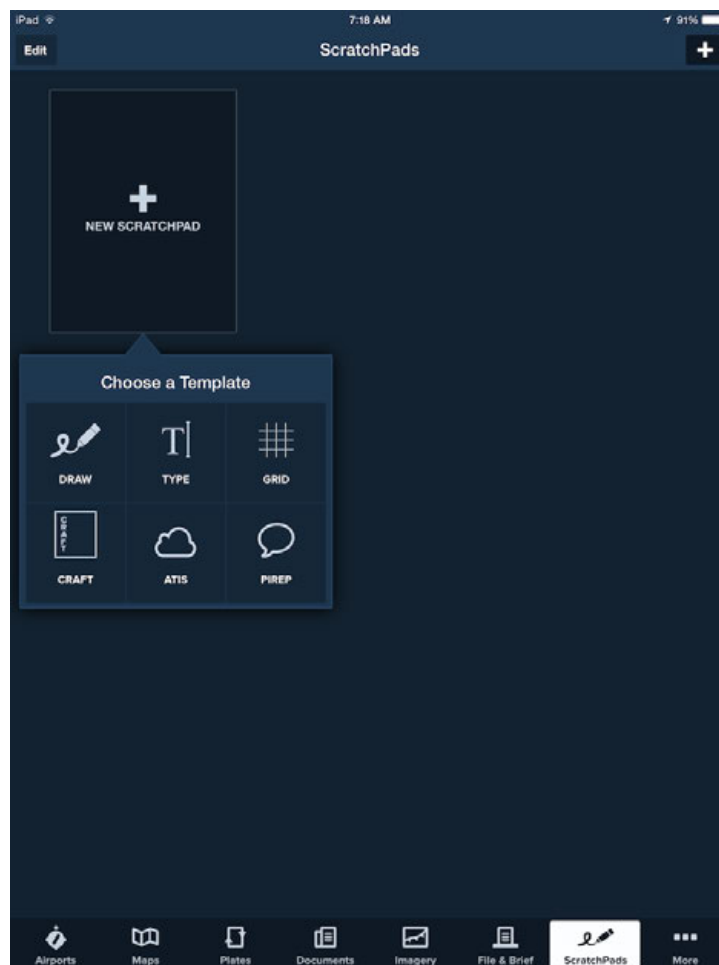

ScratchPad Templates

When creating a new ScratchPad page, there are six templates to choose from:

DRAW: Freehand drawing using the selected Pen type & color.

TYPE: Text ScratchPad for typing using the on-screen keyboard.

GRID: Freehand drawing with underlying grid.

CRAFT: For IFR pilots: Cleared-to, Route, Altitude, Frequency, Transponder.

ATIS: Fields for ATIS information using freehand drawing.

PIREP: Fields for required and optional PIREP information using freehand drawing.

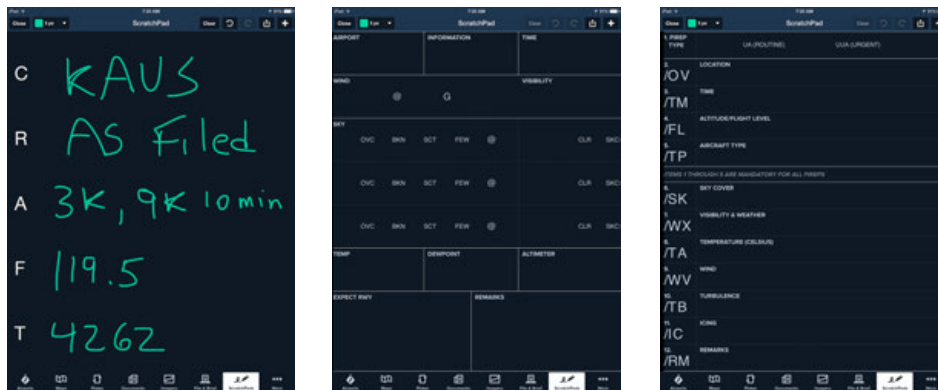

Change Pen Size, Color, Opacity

Tap the **Pen Settings** button at the top-left to change the size of the pen used for drawing on the ScratchPad. Choose the Color, Opacity and Thickness as desired.

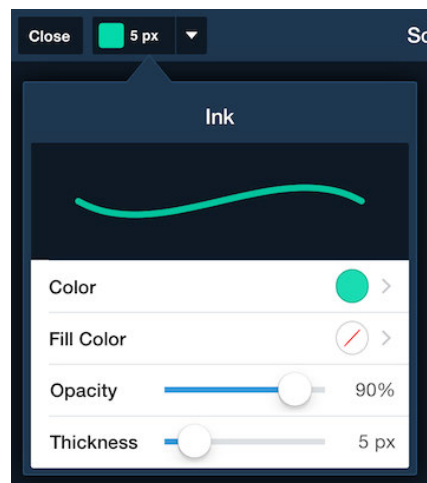

IMPORTANT: Leave Fill Color as transparent (white background with a red slash)

Undo/Redo

While entering information on a ScratchPad, tap the Undo button one or more times to undo recent changes. Tap the Redo button one or more time to redo changes that were recently undone.

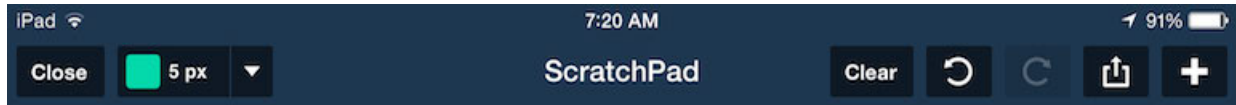

Clear ScratchPad Content

When viewing a ScratchPad, tap the **Clear** button near the top-right to clear all information you have entered on the ScratchPad. A confirmation window will appear to confirm that you really want to clear everything.

Edit a ScratchPad Name

The default name for a ScratchPad is the date and time that the ScratchPad was created or last edited.

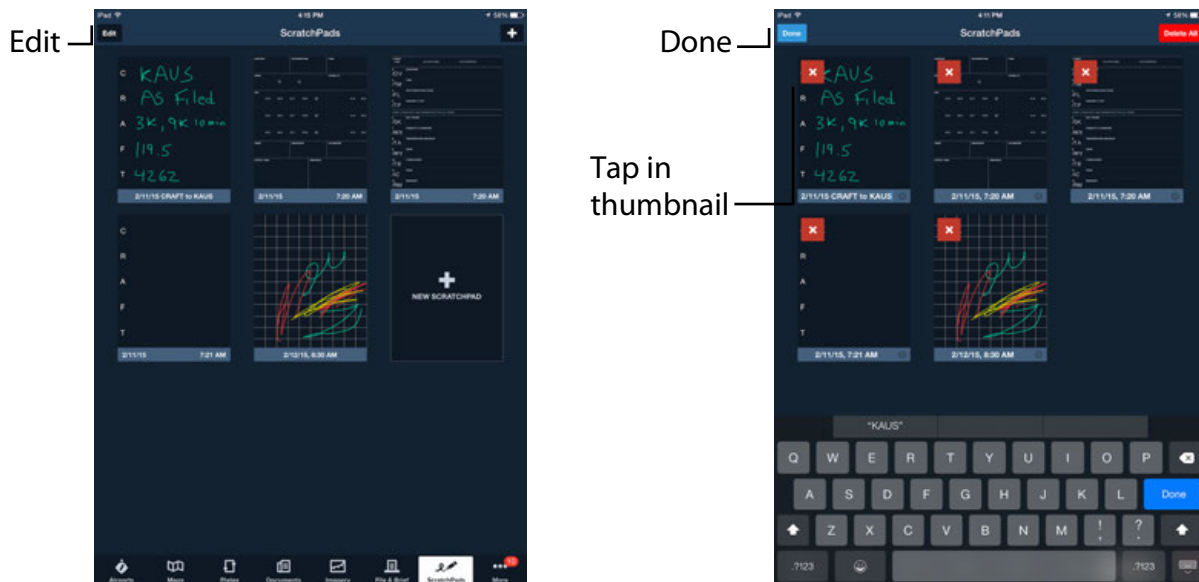

To rename a ScratchPad, close any ScratchPad so you're viewing the main ScratchPad page. Tap the "Edit" button in the upper-left corner of the screen, then tap the text you would like to edit in the blue area at the bottom of the ScratchPad. Type the new name, then tap "Done" in the upper left corner or on the keyboard.

Reposition ScratchPad Thumbnails

To change the position of ScratchPads thumbnails, tap the “Edit” button in the upper-left corner of the screen, then touch-hold on a ScratchPad thumbnail and drag it to the new position. Tap “Done” when you have finished repositioning the ScratchPad thumbnails.

Send a ScratchPad

Tap Send-To button to send a PDF copy of a ScratchPad via email or Message.

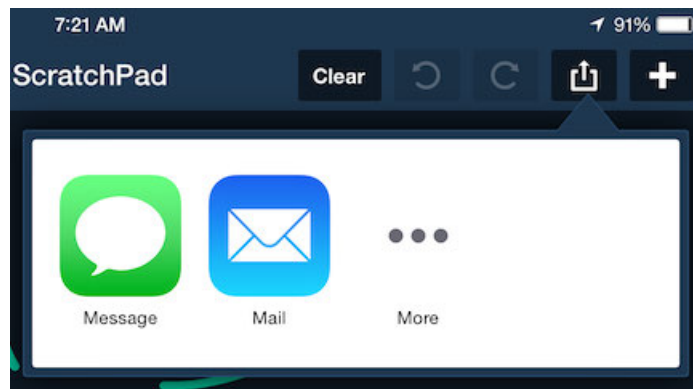

Delete a ScratchPad

From the main ScratchPads page, tap the “Edit” button (upper left) then tap the “X” button in the upper left corner of the thumbnail of the ScratchPad you want to delete.

IMPORTANT: ScratchPads are deleted immediately when you tap the “X.”

Or tap the “Delete All” button in the upper right to Delete All ScratchPads, then tap the button to confirm deletion.

More

The *More* view provides access to account info, application settings, aircraft, user waypoints, and the *About* view. Tap the options on the left to view each of these different sub-views.

Downloads

About the Design

The *Downloads* view lets you keep ForeFlight Mobile up to date with the latest airport data, diagrams, procedures, and charts. Select the data you want to download, then come back to the whenever new data is available. Look for the red number on the “More” tab, and the “Downloads” view to see when new data is available. All the data you download is available offline, whether you’re up in the air or just away from an Internet connection.

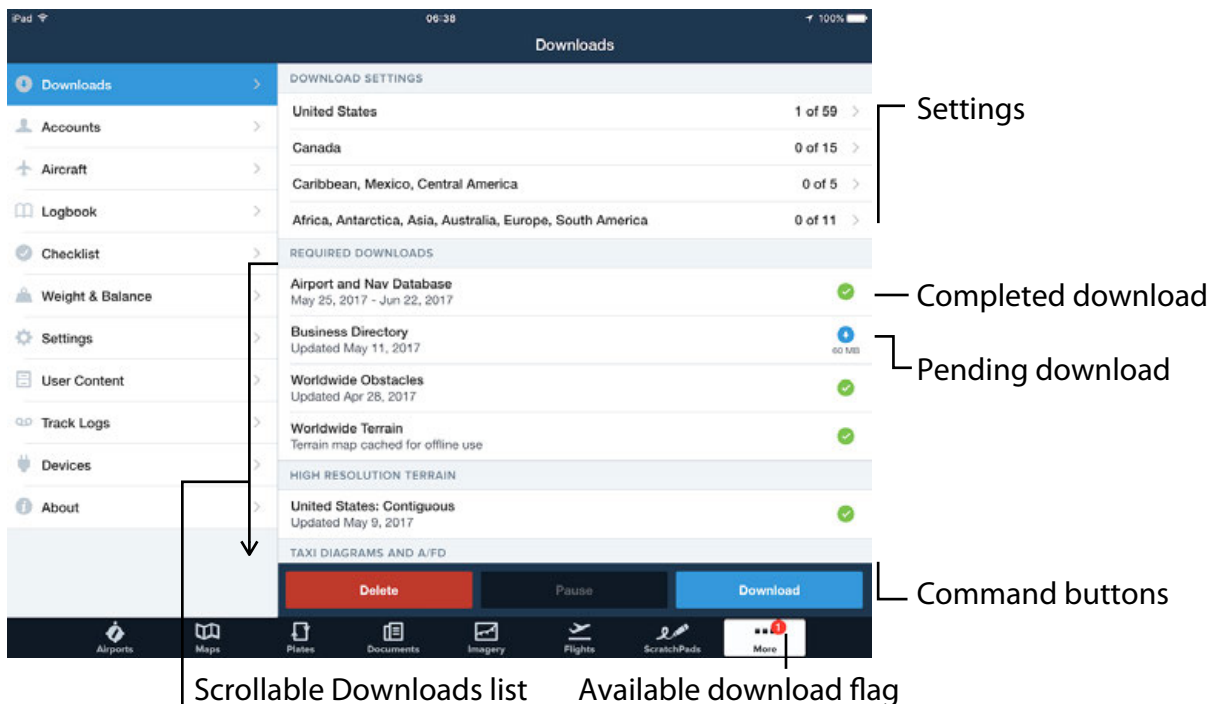

Delta Downloads

ForeFlight's Delta Downloads automatically downloads only the changes in months after an initial download of data. This provides for up to a 70% reduction in download time. Delta Downloads include terminal procedures, taxi charts, IFR and VFR charts, FAA A/FD, and Canada Flight Supplement data.

With Delta Downloads when you select a state for download in More > Downloads, if a chart crosses a state border, then the whole of that chart will be downloaded. For example North Dakota is covered by the Billings and Twin Cities VFR Sectionals, so ForeFlight Mobile will now download both of those charts if you select North Dakota.

South Dakota is also covered by the Billings and Twin Cities, as well as Cheyenne and Omaha VFR Sectionals. So selecting South Dakota will download all 4 Sectionals. Or if you previously had selected North Dakota, adding South Dakota will add just Cheyenne and Omaha VFR Sectionals.



Grouped Downloads

Delta Downloads groups downloads by state, resulting in less clutter on the Downloads page while also allowing you to expand the states to see the individual charts. States with a caret  next to them can be expanded and retracted by tapping the caret.

Downloaded charts that cross states that are not “subscribed” to, such as charts downloaded with Pack, are stored in a group called “Packed and Unselected Regions.” This makes it easy to locate and delete these charts when they are no longer needed and device memory is limited.

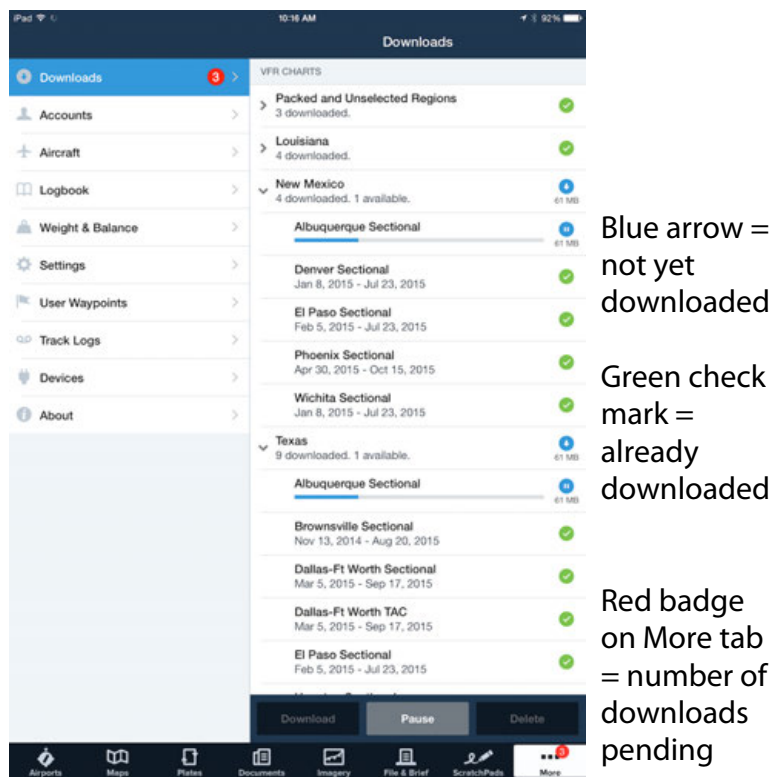

Because charts may cross multiple state borders, the same chart may appear under multiple state listings. In the example above, the Albuquerque Sectional is downloaded for both New Mexico and Texas.

Select Data to Download

When you first install the app, visit *Downloads* and select the data you’ll need to bring with you. In *Download Settings* at the top, tap on the country in which you’ll be flying. A view will slide in with the available data types for the country listed at the

top and an ON/OFF toggle switch next to each one.

Decide on the appropriate data for your type of flying and toggle it to **ON**. VFR pilots will need *Taxi Diagrams & A/FD* and *VFR Charts*, but will not need *Terminal Procedures* or any IFR Charts. IFR pilots will also want terminal procedures along with low and/or high enroute charts.

Below the data types is a list of all regions in the country with available data. Tap on a region to select it - a check mark appears on the right and the row will be highlighted in yellow. To deselect it, tap again and the check mark disappears and the row will no longer be highlighted. U.S. pilots will want to select all of the states in which they regularly fly.

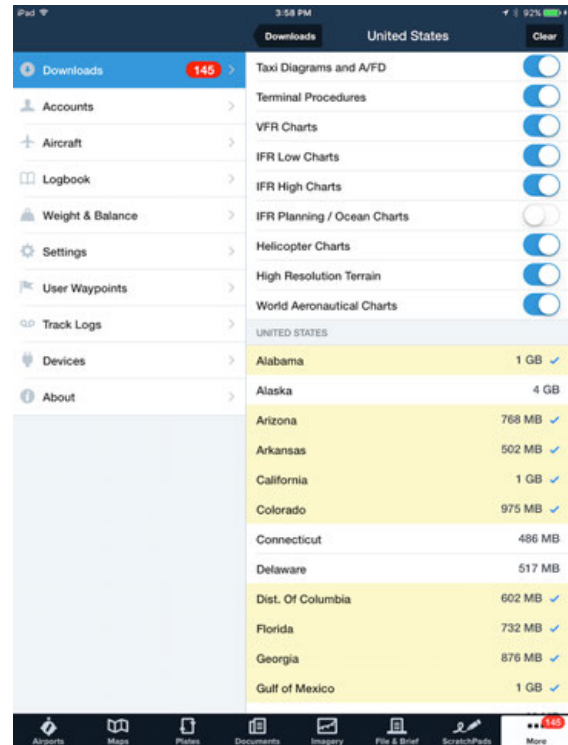

After you have finished selecting your regions, tap the **<Downloads** button in the top menu bar bar to go back to *Downloads*.



New listings with all of the data types and regions that you selected are displayed. For example, if you had toggled *Taxi Diagrams and A/FD* to ON and selected Texas and Louisiana, you'd see a table titled *Taxi Diagrams and A/FD* with the Texas and Louisiana diagrams. A blue arrow next to each region indicates that it is available to download. A green checkmark next to each region indicates that it has been downloaded.

If you'd like to download additional data types or choose new regions, go back into the *Download Settings* at the top. Continuing our example, if you were to set *Terminal Procedures* to **ON** and also select *Oklahoma*, the *Downloads* screen would add Oklahoma to the list of Airport Diagrams available for download and show a new *Terminal Procedures* table with Texas, Louisiana, and Oklahoma.

Downloading Data

Tap the blue arrow to download an individual region, or tap the blue **Download** button at the bottom of the screen to start downloading all of the data, two to four items at a time. You can stop the download at any time by tapping the **Pause** button. If you stop in the middle of a download, don't worry - it will automatically resume where it left off later.

When your download has finished, you'll see a green check mark on the right side. When all of the downloads have completed, the blue **Download** button at the bottom becomes disabled. All the data you downloaded can be used offline - you're now ready to fly!

Tip: if at all possible, use a *Wi-Fi* connection for these downloads. Downloads over the cellular network are much slower and, depending on your mobile contract, can result in bandwidth fees.

The new data for the next data cycle is generally made available to download 5-7 days before the effect date of the next data cycle. During that time, tapping the blue **Download** button will download data for both the current data cycle and the future data cycle.

Touch-hold on the blue **Download** button to choose to download only the Current data cycle data, or only the Future data cycle data.

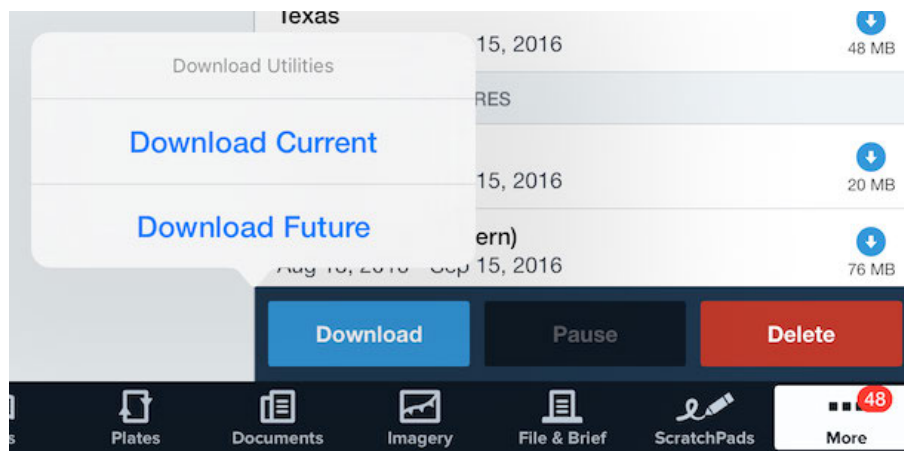

Downloading in the Background

Background downloading is currently available on devices running iOS 6 or later. However iOS 6 and later may halt a batch of background downloads before they are complete, especially if a large amount of data is being downloaded. Additionally, downloading will automatically stop if it was started when on a WiFi connection and

the WiFi signal is lost. A download batch that was started when on a cell-data connection will not continue in the background.

A Notification Center alert notification will be shown on the screen once the downloads are complete (or if they fail for any reason).

Keeping Current

New data is available every 28 days for diagrams, procedures, and VFR charts, and every 56 days for IFR enroute charts. A few days before the current data will expire, you'll see a red badge with a number appear on the **Downloads** button. This is the number of data downloads available for the next data cycle. When you see the red badge, it's time to download new data.

To download the new data, go to the *Downloads* view and tap the big blue **Download** button at the bottom. All data you've selected will queue up and download. If you don't already have a region downloaded or it's expired, then the new data will be used by the app immediately. If you already have current data for the region and you're downloading the new data a few days in advance, ForeFlight Mobile will save it on your device but keep using the current data.

The first time you start the app after the current data expires, the new data starts being used and the old data is deleted. This data cycle changeover happens automatically.

Deleting Data Downloads

All data downloads can be deleted by tapping the **Delete** button at the bottom of the *Downloads* view. The option is given to delete *All* data or just *Expired* data. Expired data is deleted automatically but for performance reasons, may not disappear immediately upon expiration. After updating to ForeFlight Mobile 7.0 or later, you can delete older non-Map Touch enabled charts by tapping Delete and choosing **Delete Legacy Charts**.

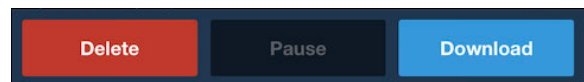

To delete an individual download, for example if a region has been downloaded that is no longer needed, swipe-to-delete the data row. Slide your finger from right to left across the entry you wish to remove and a red **Delete** button pops up. Tap on the button to remove the download. If you never want to download data for this region again, be sure to remove it from the list of regions that ForeFlight keeps track of for you by unchecking it in the *Download Settings* view.

Deleting an individual chart that appears under multiple states will remove it from all the states that it appears under. If a state includes charts present in other states, swiping to delete that state will display a pop-up to choose to delete only the charts

that are unique to that state, or to delete all of its charts including those that appear under other states. If a state has only “unique” charts, no pop-up appears.

A Quick Tour of the Data Available for Download

- ❖ **Airport and Nav Database** is an international A/FD with over 27,000 airports and NAVAIDS from 220 countries. This data is used in the *Airports* view (frequencies, runways, hours, FBOs, etc) and in the *Maps* view (locations, routes, NAVAIDS, airspaces), and includes data used in the Aeronautical data layer.
- ❖ **Business Directory** contains the information about FBOs and services at airports.
- ❖ **Worldwide Obstacles** are Jeppesen-provided towers, bridges, etc. These are shown as markers on the Map view when the Obstacles or Hazard Advisor layers are enabled.
- ❖ **Worldwide Terrain** is the low-resolution terrain data used to add terrain features to the base map via the switch in Maps Settings. This map provides global coverage and is only available if downloaded.
- ❖ **Jeppesen Charts** can be added to ForeFlight and downloaded as separate downloads for enroute charts and terminal charts. See [Jeppesen](#) for information on adding Jeppesen charts.
- ❖ **High Resolution Terrain** can be downloaded for any region on Earth to improve upon the low resolution terrain map. High Resolution Terrain for locations outside of N. America and the Caribbean can be selected for download in the fourth Download Settings item: “Africa, Antarctica, Asia, etc.”
- ❖ **Taxi Diagrams and A/FD** contains thumbnail diagrams with FBO locations for over 1,200 worldwide airports and taxi diagrams for U.S. airports. These are displayed at the top of an airport in the *Airports* view. Additionally, A/FD pages for that region are included. These are displayed in the lower portion of the *Airports* view. **Note:** Downloads for Canadian **Airport Diagrams** also include the Canadian CFS.
- ❖ **Terminal procedures** and approach plates for U.S. airports or Canadian airports, viewable in the *Procedures* tab of an airport in the *Airports* view.
- ❖ **VFR, IFR High, and IFR Low Charts** (United States) contains FAA seamless sectionals and enroute charts of the U.S. and southern Canada for use in *Maps*.
- ❖ **VNC Charts** (Canada) contains Nav Canada seamless VNC and VFR Terminal Area (VTA) charts.

❖ **IFR High, and IFR Low Charts** (Canada) contain Nav Canada seamless enroute charts of Canada and the Atlantic ocean.

❖ **Helicopter Charts** - US Helicopter charts for 9 major metro areas (downloaded when switch is ON and containing state is selected) and US Gulf of Mexico VFR and IFR Helicopter charts (downloaded when Gulf of Mexico is selected).

❖ **High Resolution Terrain** (ForeFlight Mobile Pro, Pro Plus, and Performance Plus only) contains high-resolution terrain data used for the Terrain map layer, Hazard Advisor™, and Synthetic Vision. To download data for countries outside the US or Canada, tap the “Africa, Antartica, Asia, Australia, Europe, South America” category, turn on “High Resolution Terrain” and select the geographies you need.

❖ **Documents** are updated via this Downloads view once added to a binder in the Documents view.

Approximately 8GB of data is available for download each month in the continental United States, and 2GB in Alaska.

Note: It isn't necessary to have all the data downloaded to make the app function properly. The downloads are only required for in-cockpit (or offline) use. Most pilots will download the states they will be flying through and leave other states alone if they are not flying there. If plans change, you can just grab the additional states in a few minutes of downloading. Downloading all items for all states can be unnecessarily time consuming - particularly if there are items you're likely to only reference when you're on the ground with an Internet connection.

Preflight Download Check

Remember: If it's not downloaded, you're not going to see it in flight.

Before your flight, make sure you have the necessary data downloaded:

❖ Use the [Pack](#) feature to automatically download relevant METARs, TAFs, AIR/SIGMETs, TFRs, Fuel prices and Airport NOTAMs.

❖ Go to **Settings** for your iPad and switch *Airplane Mode* **ON**. This will keep the app from retrieving data over the Internet, simulating the condition in flight.

❖ Launch **ForeFlight Mobile**

❖ Tap **More** and then **Downloads** and ensure there is a green check mark next to each region where you'll be flying.

❖ Tap **Airports** and search for each airport on your route. If you're flying IFR, make sure there is a green “saved” mark next to each procedure.

❖ **Tap Maps** and search for each airport on your route. Toggle between *VFR*, *IFR Low*, and *IFR High*, panning around each chart to ensure that it is downloaded properly on your device. Make sure to zoom into the airports you will be flying to and ensure that the charts are downloaded.

Troubleshooting Downloads

ForeFlight hosts all of the data for downloads on a network of servers located across the United States and around the world. When you start a download, the data comes from the server that is closest to you in order to provide fast and reliable downloads.

Depending on the amount of data you are downloading, download time can be considerable. If downloading all items for the USA, 8-10 GB of data will be downloaded. Even on a fast Wi-Fi connection, this will take a significant amount of time.

ForeFlight *strongly recommends* that you only download data for regions you will fly over or near. This will save a significant time and disk space.

Given the nature of networks and the large amount of data transferred every month, connection errors can occur. If a download fails, the app will automatically retry a few times. If you see a red error message on the download, that means the retry attempts did not work and you will need to restart the download for that particular item.

Try these troubleshooting tips:

❖ **Enable Diagnostic Logs** - in More > Settings, turn **Enable Diagnostic Logs** *ON* to save a log file of your download attempt. Then try the download again. If the download doesn't work, make sure that your Mail client is set-up with an email address that can send message. Then in ForeFlight Mobile, tap More > Settings then tap the word "Settings" in the header area at the top of the page, 3 times in quick succession. This creates a diagnostic email pre-addressed to the ForeFlight Pilot Support Team at team@foreflight.com. Send that email along with an explanation of your download difficulty and we will investigate.

❖ **Try downloading on another network** - if you're using your home Wi-Fi, try a download over a different Wi-Fi hotspot or, in a pinch, over 3G/4G.

❖ **Update the firmware on your router** - some older Wi-Fi routers are not compatible with the iPad. Visit your manufacturer's website to see if there is a firmware update available.

❖ **Reboot your iPad** by pressing and holding the button on the top of the iPad. A red slider appears on the screen - swipe where indicated to shut down your device. Wait a few seconds, then press the button again to start it back up. Once it has finished starting up, try the downloads again.

❖ **Double check Download Settings** to ensure the proper regions and data types are still selected.

Accounts

About the Design

The *Accounts* view shows the status of your ForeFlight subscription and allows you to proceed to <https://www.foreflight.com/pricing> to upgrade or renew an existing subscription, or to purchase a new subscription.

If you're setting up a new device or retiring an old one, use *Accounts* to sign in and out of your ForeFlight account.

Viewing your Active Subscription

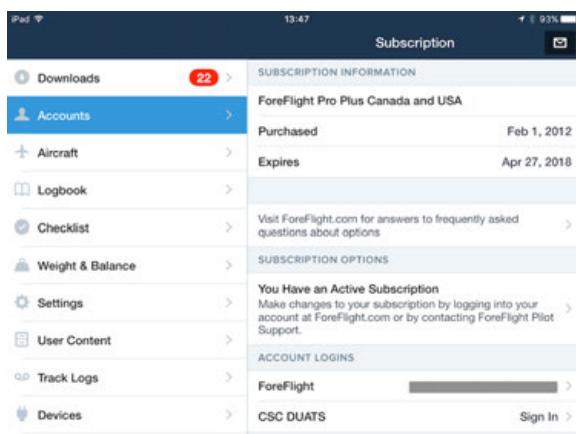

Current Plan and Expiration Date

Upgrade, renew, or add a region
at www.foreflight.com/pricing

ForeFlight Account Sign-In
NOTE: Sign OUT of DUATS to file and brief via Leidos.

The table at the top of Accounts shows the status of your account. If you're a trial user, it shows the day you started using the app and when your trial will expire. If you've already purchased a subscription, it shows the day you placed your order and when you need to renew.

A valid subscription is required to continue using the app.

If your expiration date is not correct, then you need to sign in to your ForeFlight account (see below). Apple does not provide us a consistent method to automatically detect when you start using a new device, so ForeFlight Mobile won't recognize your subscription until you sign in. Also, subscription information can be lost in certain upgrade, backup and restore operations of the device or application, making it necessary to sign in.

Purchasing or Renewing a Subscription in the United States

To purchase or renew a subscription for the US, visit www.foreflight.com/pricing or tap on a plan:

- ❖ **\$99.99 (USD) Basic Plus - US, 1 Pilot for 1 Year**
- ❖ **\$199.99 (USD) Pro Plus - US, 1 Pilot for 1 Year**
- ❖ **\$299.99 (USD) Performance Plus - US, 1 Pilot for 1 Year** (available only at www.foreflight.com/pricing)

The screenshot displays the ForeFlight pricing page with the following structure:

- Header:** ForeFlight logo, navigation menu (PRODUCTS, SOLUTIONS, SUPPORT, COMPANY, BLOG), and a LOGIN button.
- Section:** "Simple Plans & Pricing" with tabs for "FOR INDIVIDUALS" (selected) and "FOR BUSINESSES".
- Plan Cards:** Three vertical cards representing the subscription plans:
 - BASIC PLUS (\$99.99/yr):** Includes Logbook and Weight & Balance. Features include: Flight Planning in App and on the Web, International Flight Plan Filing, Graphical Briefing, Aviation Weather, Global Data-Driven Aeronautical Maps, VFR, IFR & ForeFlight Taxi Charts, Airport & FBO Information, Global Navigation Data, Aircraft Weight & Balance, Logbook, Avionics Connectivity, and Printable NavLog.
 - PRO PLUS (\$199.99/yr):** Everything in Basic Plus Plan, and Geo-Referenced Plates and Synthetic Vision. Features include: Everything in Basic Plus, Geo-Referenced Approaches & Charts, Plates on Maps, Hazard Advisor, Profile View, Synthetic Vision, Cloud Documents, and Flight Notifications.
 - PERFORMANCE PLUS (\$299.99/yr):** Everything in Pro Plus plan, and next-generation planning for high-performance aircraft. Features include: Everything in Pro Plus, Detailed Aircraft Performance Profiles, Next-Generation Planning Engine, Accurate Time & Fuel Calculations, Optimized AviationCloud Routes, Fuel Policies & Payload Safety Checks, and Integrated JetFuelIX Prices.

US subscriptions do not provide access to Canadian terminal procedures or IFR enroute charts from Nav Canada. You can add Canadian data to your plan at www.foreflight.com/pricing.

NOTE: If you are using an iTunes gift card towards the purchase, make sure you have redeemed the card (eg: deposited its value in your iTunes account) before you tap the button to purchase the subscription.

After your purchase is complete, you'll receive a receipt via email, as well as an email to set-up your ForeFlight Account password (if needed).

If you would like to place an order for multiple iPads, please visit www.foreflight.com/pricing or send an email to sales@foreflight.com.

Purchasing or Renewing a Subscription in Canada

To purchase or renew a subscription for Canada, visit www.foreflight.com/pricing or tap on a plan:

- ❖ **\$99.99 (USD) Basic Plus - Canada, 1 Pilot for 1 Year**
- ❖ **\$199.99 (USD) Pro Plus - Canada, 1 Pilot for 1 Year**
- ❖ **\$299.99 (USD) Performance Plus - US, 1 Pilot for 1 Year** (available only at www.foreflight.com/pricing)

These plans have all the same features as their respective US plans, with the exception that Canadian aeronautical products from Nav Canada are provided in place of US data. These include monthly data updates to download terminal procedures from the Canada Air Pilot (CAP), Canadian IFR low and High enroute charts, and Canadian VNC & VTR charts and Canadian Flight Supplement (CFS).

Canadian subscriptions do not provide access to US plates, sectionals, or enroute charts. You can add US data to your plan at www.foreflight.com/pricing. Note: If you purchase Synthetic Vision it applies to all geographies on your subscription plan.

Signing In to your ForeFlight Account

After you purchase a subscription, you are automatically signed in on that iPad or iPhone.

To use your subscription on a new device, you'll need to sign in to your ForeFlight Account inside the application:

- ❖ Tap the "More" tab at the bottom, then "Accounts" in the left side list
- ❖ In the *Account Logins* section, tap *ForeFlight*
- ❖ Enter your email and password for your ForeFlight account.

If you can't find your password, enter the email address that you originally used to purchase your subscription and tap the **Forgot Password** button. An email will be sent to you with instructions for resetting your password.

Signing Out of your ForeFlight Account

When you're ready to retire your old iPhone or iPad and won't be using it anymore, remember to sign out of your ForeFlight Account on that device:

- ❖ Tap the "More" option at the bottom, then "Accounts" in the left side list
- ❖ In the *Account Logins* section, tap *ForeFlight*
- ❖ Tap **Sign Out** at the bottom and confirm.

This will "unhook" the device from your account. Afterwards, we recommend deleting the app from your device to free up space if you don't plan to use the app on that device again. Tap-and-hold on the ForeFlight icon until it starts to wiggle, then tap the "X" button displayed on the top-left corner of the icon.

Changing your Password or Email

To change your password or email address inside the app:

- ❖ In the Account Logins table at the bottom, tap *ForeFlight*
- ❖ A screen is displayed with your email address and password. Tap **Change Password** or **Change Email** at the bottom. **NOTE:** Change Email is used to update your existing account's address. If you need to switch to a different or new account, sign out of your existing account and sign back in to the other account.
- ❖ Follow the on-screen instructions for changing your password or email.

You can also use the ForeFlight Manage website to change your email, password, and manage which devices are associated with your account. ForeFlight Manage is available at: www.foreflight.com/manage.

Removing Devices from your Account

If you are signed in to your ForeFlight account on other devices, they will be shown on the Accounts view under "Also Signed In On." You can remove a device from your account, which is the same as signing out of your account on that device, by tapping the red Remove button and entering your ForeFlight credentials.

ALSO SIGNED IN ON	
Sam's iPhone iPhone 5s (A1433/A1453)	Remove
Sam's iPad iPad mini 3 (Wi-Fi)	Remove

Providing a DUATS Account

A CSC DUATS account can also be *optionally* provided by tapping the *DUATS* option at the bottom of the Accounts view. When your DUATS account is set, the Flights view will use it when filing or briefing flight plans.

When your CSC DUATS account is not provided and you select the “FAA/Domestic” flight plan option, ForeFlight Mobile will automatically use the ForeFlight corporate DUATS account. If you select the “ICAO” flight plan option, ForeFlight Mobile will file the plan with Leidos.

Signing Out of your DUATS Account

If you are signed-in to a CSC DUATS account but would like your flight plans to be filed with Leidos, you first need to sign out of your CSC DUATS account. Tap **More > Accounts** then tap on your CSC DUATS number.

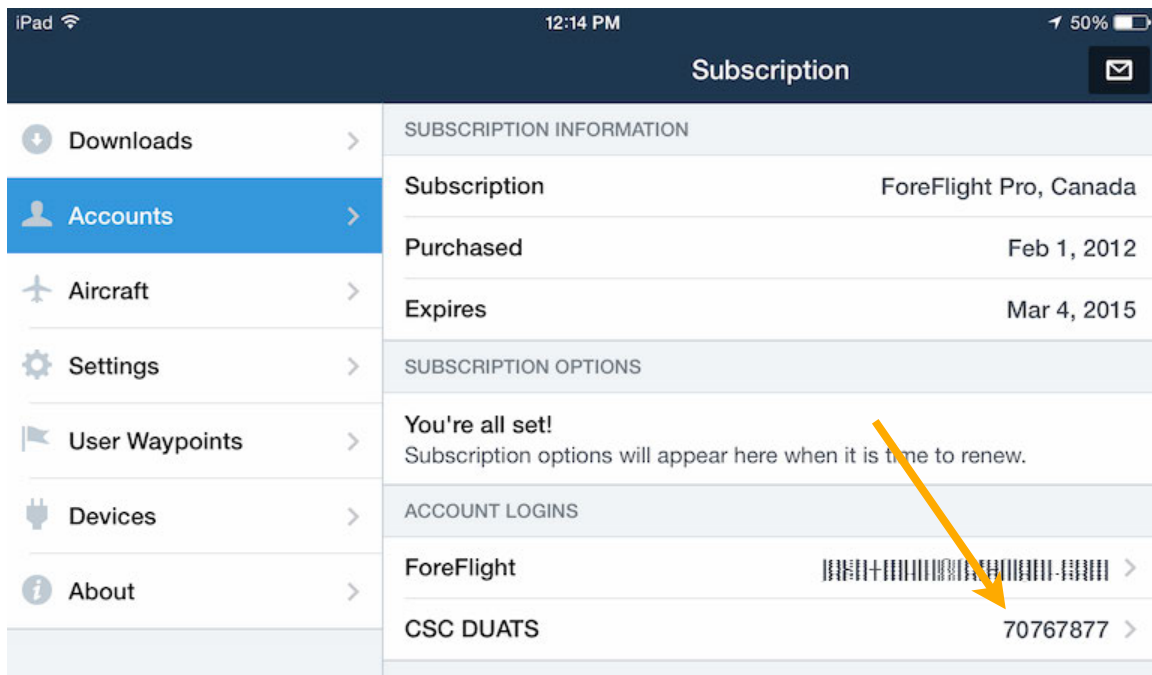

On the next page, tap the red “Sign Out” button.

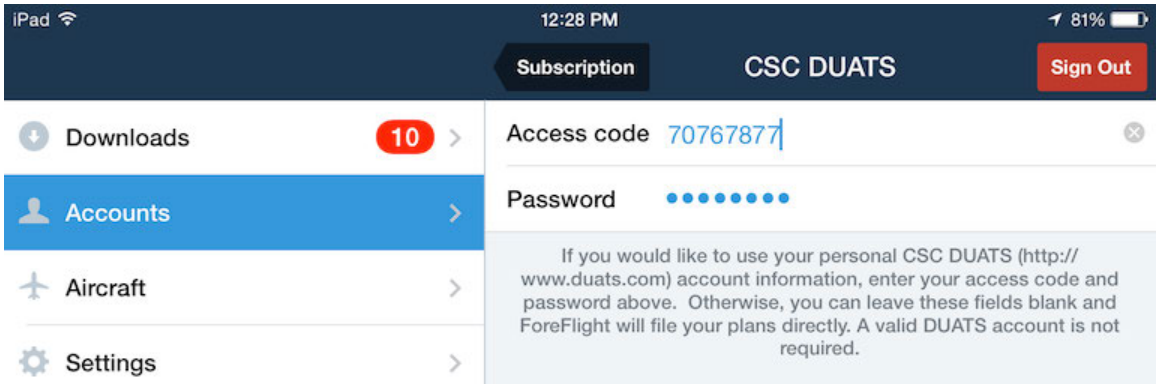

Aircraft

If you have a Performance Plus subscription, please refer to the Performance Plus guide (available in the app in Documents > Catalog > ForeFlight) or online at <http://foreflight.com/support/performance/pdf> for additional details about the Performance Plus flight planning features.

NOTE: For creating and editing aircraft in ForeFlight [Logbook](#), please refer to the **Logbook in ForeFlight Mobile** guide in Documents > Catalog > ForeFlight, or at www.foreflight.com/support.

Create or Edit an Aircraft

Create a new Aircraft on the More > Aircraft tab, by tapping the “+” button to create a new Aircraft from scratch, or by tapping the “>” to the far right of an existing aircraft, scrolling down, and tapping “Copy Aircraft.”

Edit an Aircraft by tapping the “>” at the right of an existing Aircraft.

The General section includes basic information about your aircraft like the Tail Number, aircraft color, and Home Airpot. The Aircraft type (used for filing flight plans) includes a built-in type code lookup. Tap “Aircraft Type” then enter the aircraft model or make in the search box. Scroll through the list to find the correct aircraft, the tap that entry to set it as your aircraft’s type code.

In the **Glide Performance** section, enter your aircraft’s Best Glide Speed and Best Glide Ratio. For the Best Glide Ratio, enter the part before the :1. eg: For a ratio of 7.8:1, enter only 7.8 with no : or :1.

The Default Cruise Altitude sets the default Flights altitude, and the Maximum Ceiling sets the upper cut-off for the Altitude Advisor. Not entering a value for Maximum Ceiling will result in the Altitude Advisor returning results up to FL570.

Aircraft		+
N101FF (Default Aircraft)	C82R	>
N101FFF	C82R	>
N101FFP	TBM8	>
N101FFT		>

CESSNA AIRCRAFT	
182 Skylane	C182 <input type="radio"/>
182G Skylane O-470-R	C182 <input type="radio"/>
182H Skylane O-470-R	C182 <input type="radio"/>
182J Skylane	C182 <input type="radio"/>

GLIDE PERFORMANCE	
Best Glide Speed	
Best Glide Ratio	

ALTITUDES	
Default Cruise Altitude	8,000
Maximum Ceiling	18,000

FUEL	
Fuel Type	100LL
Fuel Units	Gallons
Start/Taxi/Takeoff Fuel	

The Start/Taxi/Takeoff Fuel is the number of units (typically gallons) of fuel that your aircraft burns during Start, Taxi, and Takeoff.

IMPORTANT: Mistakenly entering a value as gallons per hour, instead of the total number of gallons burned during start, taxi, and takeoff may result in erroneously high fuel burn values for the trip.

The Filing section includes the FAA and ICAO equipment needed to file a flight plan. For full details about ICAO Equipment, ICAO Surveillance (eg: transponder or ADS-B Out), see the “Filing with ForeFlight” guide in More > Documents > ForeFlight, or online at <https://foreflight.com/support/filing/pdf>.

Aircraft	N101FF
FILING	
FAA Equipment	/G
ICAO Equipment	G, S
ICAO Surveillance	None
ICAO Wake Category	L
ICAO PBN	None
Other Information	0 items
STS Special Handling	None
DINGHY	
Count	
Capacity (Persons)	
Color	
Covered	<input type="checkbox"/>
EMERGENCY	
Life Jackets	None
Radios	None
Survival	None
Survival Equipment Remarks	
Make Default	
Copy Aircraft	
Delete Aircraft	

Basic Performance Profile

The Performance section lets you create one or more basic performance profiles (eg: climb, cruise, and descent performance) for your aircraft. To create a profile, tap Performance Profiles, then tap "Add Custom Performance Profile."

You can create as many profiles as you wish for each aircraft, but only one profile will be used for a particular flight.

Name the profile, then at minimum enter the Cruise TAS and fuel burn. For more accurate performance calculations also enter the Climb and Descent TAS, fuel burn, and rate of Climb/Descent.

When you finish entering the information, tap the <Performance Profiles button to go back to the Performance Profiles menu. To set a particular performance profile as the Default for that aircraft, tap the Profile, scroll down, and tap "Make Default."

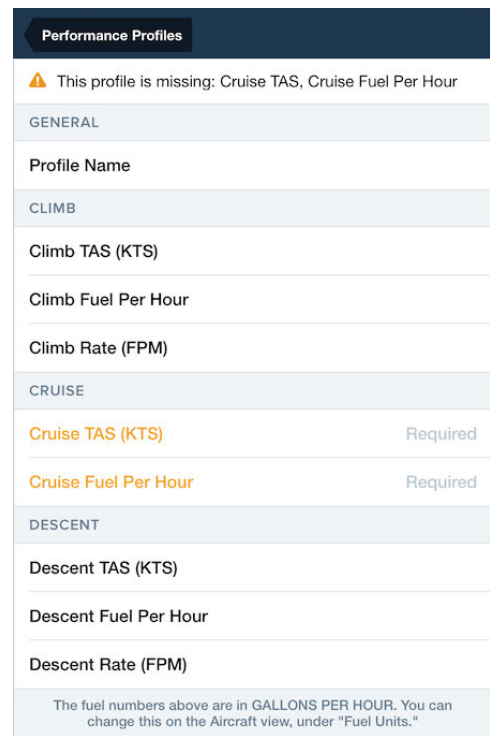
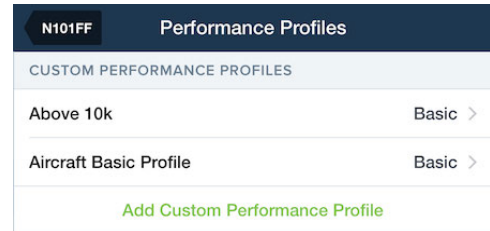
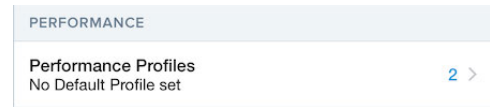

Delete Aircraft

To delete an aircraft, swipe your finger over it from right to left, then tap the red Delete button.

Manage Aircraft for Multi-Pilot Accounts

Multi-pilot account administrators can manage and distribute company aircraft profiles to all the pilots on an account, allowing for easier aircraft management and reduced setup time for large accounts.

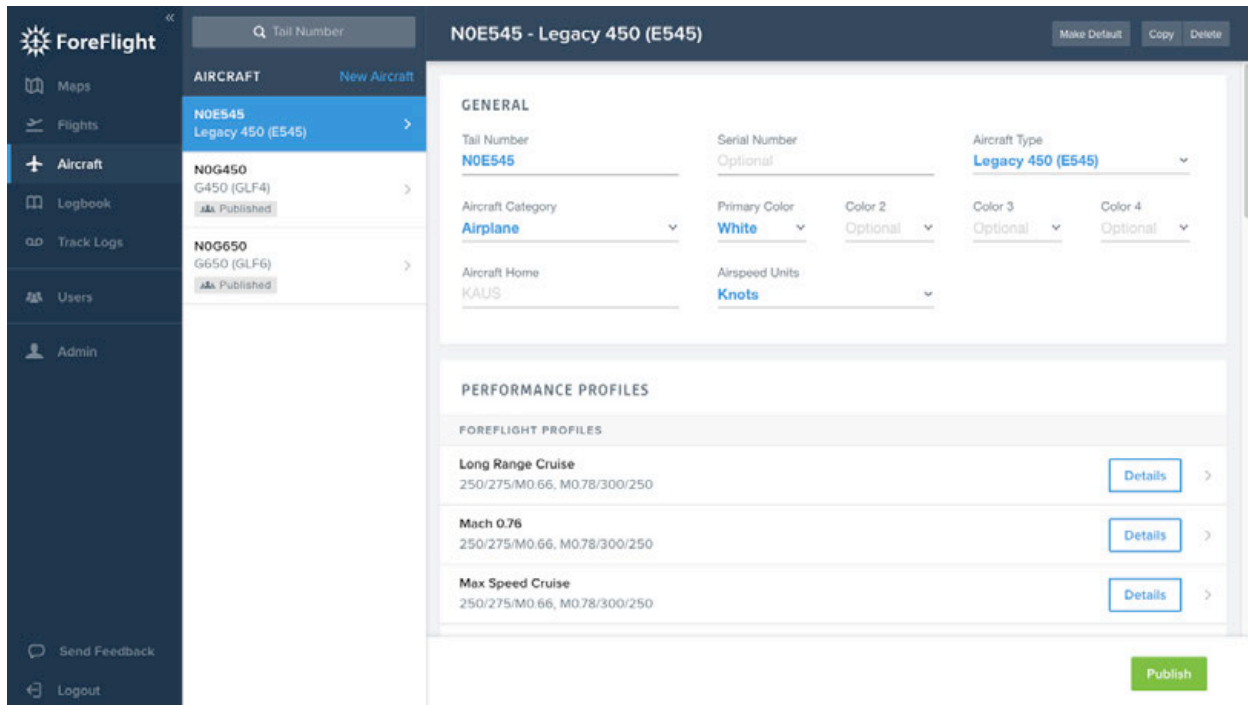

To set up company managed aircraft profiles as the administrator of a multi-pilot account, sign in to ForeFlight's [web application](#) using your username and password, then click the Aircraft tab on the left-hand nav bar. Select an aircraft that you want to share or set up a new one with the necessary details. At the bottom-right of the page is a green "Publish" button. Click this button to share the aircraft with all users on the account. Once shared, a "Published" tag will appear under the aircraft in the list view on the left, and the bottom of the page will show the date and time when you published the aircraft.

Last published on 10/01/2017 2:16pm.

Unpublish

Any time you make changes to a shared aircraft, "(Unpublished Changes)" will appear in green at the bottom of the page, and a "Publish Changes" button will appear in the bottom-right. The changes will not be shared with users on the account until you publish them. Doing so will update the "Last published" date and time at the bottom of the page.

Clicking “Unpublish” will revoke access to the aircraft for all users other than the administrator, and they will no longer be able to see or use the aircraft for flight planning, although a record of the aircraft’s tail number will remain attached to flight plans made with that aircraft.

The administrator cannot delete a published aircraft - he or she must first unpublish the aircraft, then delete it.

Aircraft that have been published by an account administrator will appear in the Aircraft list’s of all pilots on the account, along with a tag showing the email address of the administrator who published the aircraft. Pilots on the account can view the details of shared aircraft and use them for flight planning as they would their own aircraft, but all details of the aircraft are locked from editing by the pilots, including the performance profiles. Published aircraft include a message at the top of the aircraft detail view with the email address of the administrator who published the aircraft and the time and date of last publishing. Users can tap the email address to create an email to the administrator.

Pilots cannot delete shared aircraft, but they can use the buttons at the bottom of the aircraft detail view to make a shared aircraft the default for flight planning, and to copy a shared aircraft. Copying a shared aircraft creates an identical aircraft profile that they can edit, allowing them to make changes to the aircraft without affecting the original shared aircraft. Copies of shared aircraft are the same in all respects as new aircraft created by the pilot: they cannot be viewed or modified by the account administrator, and changes published to the original shared aircraft will not affect the copy.

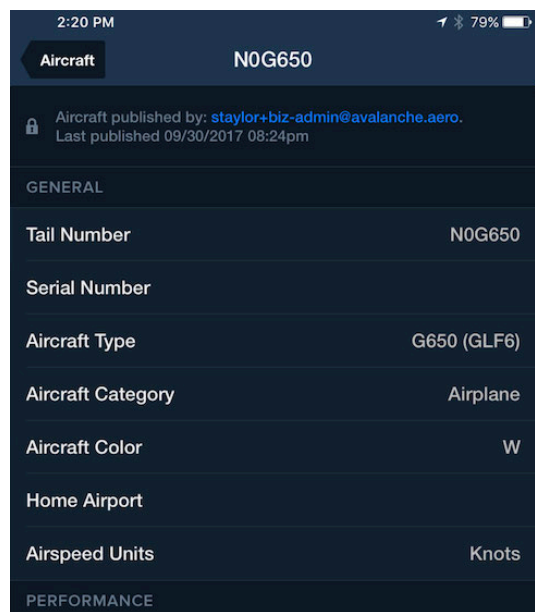
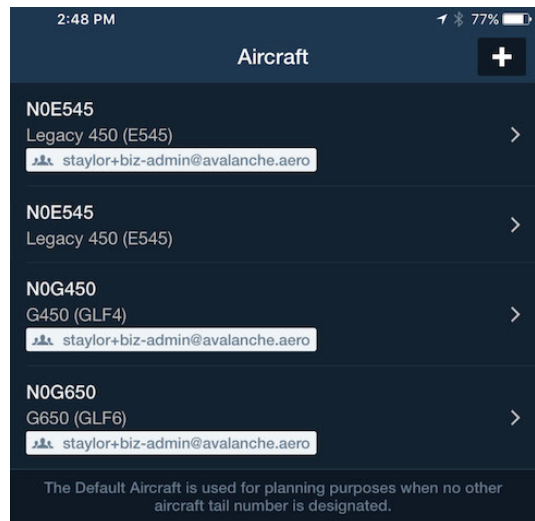

Logbook

The Logbook feature lets you track your hours, currency, ratings, endorsements, medical certificates, and more across all your devices. It is included in the Basic Plus, Pro Plus, and Performance Plus subscription plans, and as an add-on for other plans.

Your current logbook can be imported from ForeFlight on the web for easy transfer of data, and new entries can be entered manually, or automatically if Track Log auto-start/-stop is enabled.

Aircraft can be copied directly from your current aircraft, and people can be copied from your contacts and assigned various roles for each flight such as SIC, instructor, student. An endorsement feature allows instructors to sign off on a student's progress with a digital signature.

Pilots can also export a flight experience report or FAA 8710 that can be used for completing annual insurance forms, rental applications, and job applications. And new Logbook Detail Reports (in either complete or condensed versions) transform your digital flight entries into a print-ready layout for personal backup or professional job interviews.

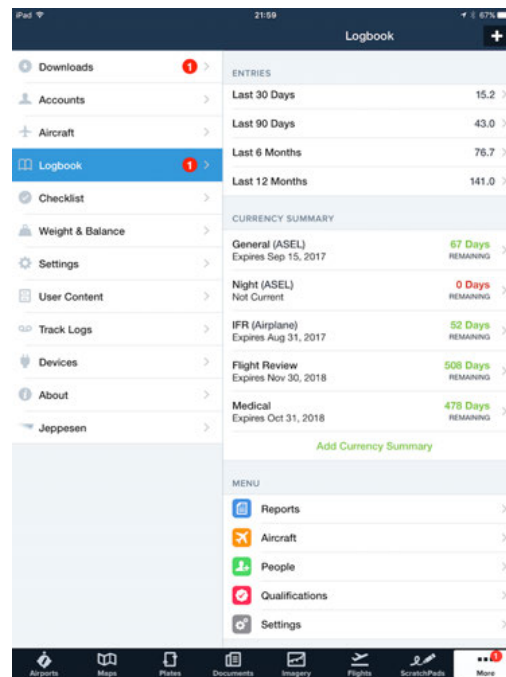

Logbook is part of the ForeFlight Cloud, allowing you to make new entries and track your currency from any device signed into your account.

For complete details, see the **Logbook in ForeFlight Mobile** guide in Documents > Catalog > ForeFlight, or at www.foreflight.com/support.

Checklist

ForeFlight Checklist lets you complete a checklist with a series of taps, and also includes easy access to Abnormal and Emergency checklists. The app includes checklist templates for a variety of fixed-wing and select rotorcraft models, all derived from pilot operating handbooks. The templates can be customized as needed to fit your particular aircraft.

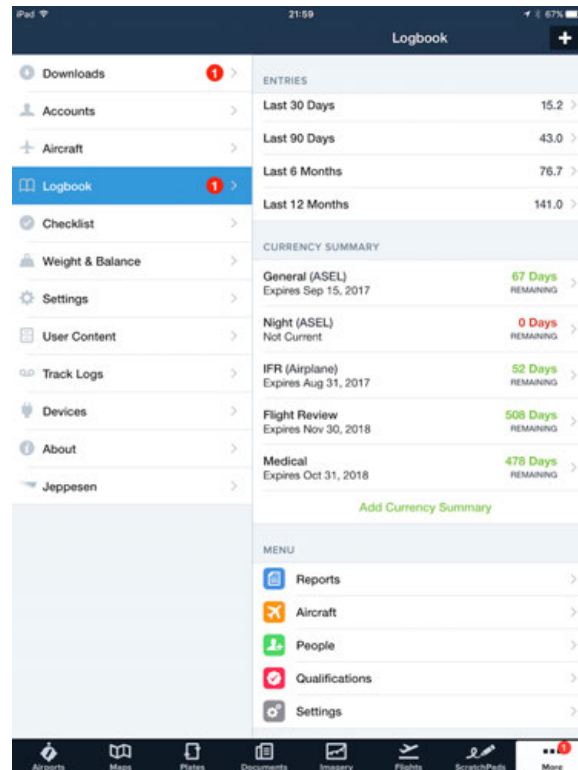

Checklist preserves your progress and location in a checklist if you tap away to another part of the app, such as the Maps view, and puts you right where you left off when you tap back into More, allowing you to seamlessly move between Checklist and your other inflight tools.

Checklist is included with ForeFlight's Basic Plus and Pro Plus subscription plans, and is available as an add-on to other plans. Visit foreflight.com/pricing to upgrade your plan level or add Checklist to an existing subscription.

Checklist Pro Migration

If you used ForeFlight's Checklist Pro for iPhone app (on iPhone and/or iPad) and your Checklist Pro account email address is the same as your ForeFlight Mobile account address, your checklists were automatically migrated to ForeFlight Mobile.

If the email address you used for the Checklist Pro account is not the same address you use for your current ForeFlight account, please contact the Pilot Support Team at team@foreflight.com with details about your Checklist Pro account email address, and we will assist you with migrating your checklists to ForeFlight Mobile.

Setting Up Checklists

Tap the Plus button in the upper-right corner of the Checklist view to set up a new checklist. You can enter a tail number manually, or tap “Lookup Aircraft” to select from your list of configured aircraft - doing so does not affect the profiles in any way, it only copies their tail numbers. Entering a tail number is optional, as is entering a name for the checklist, but this can be useful if you want to identify a checklist by more than the tail number, such as with a specific mission type.

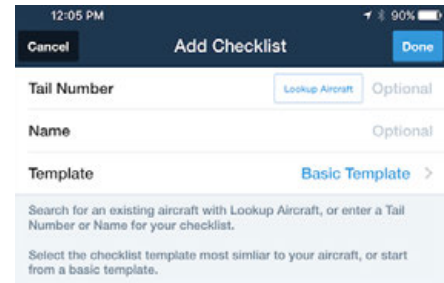

Tap “Template” to select from a list of preconfigured templates provided by ForeFlight. These templates are based on the operating handbook’s of various aircraft types and configurations. At the bottom are some templates not associated with any aircraft, including the “IMSAFE” checklist for determining readiness for flying and a “Passenger Brief” template. The default “Basic” template includes examples of each type of checklist component to help you build a checklist from scratch if you don’t use any template.

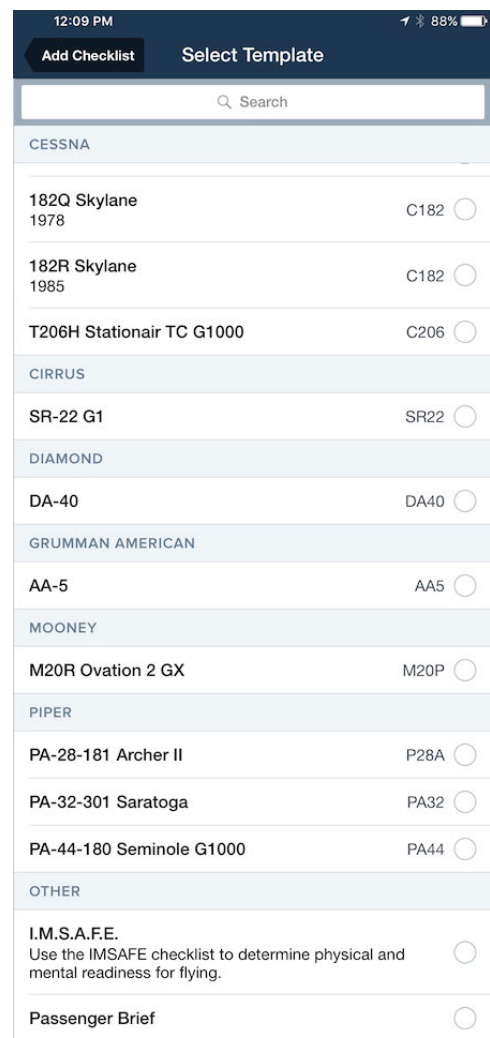

Checklists based on templates are fully editable after being created and do not affect the templates themselves in any way, so even if your particular aircraft type or configuration isn’t provided it can be helpful to start with a template for a similar aircraft.

IMPORTANT: After creating a checklist for your aircraft from one of the available templates, before using the checklist you must verify that all entries correspond to your aircraft’s POH.

Editing Checklists

All checklists include three “groups” for organizing lists: Normal, Abnormal, and Emergency. Apart from those three groups, every aspect of a checklist can be edited however you like, whether it is built from scratch or copied from a template.

Every page within Checklist has an Edit button in the upper-right - tap this to edit the contents of each page.

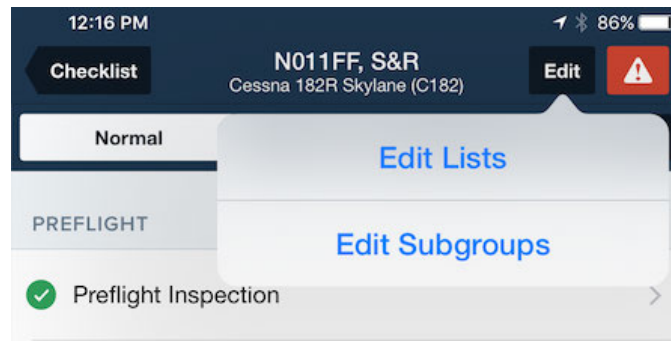

From the main Checklist view (where you can view all the checklists you’ve created) you can edit the tail number, name, and description of each checklist by tapping a checklist’s Edit button while in Edit mode. You can also re-order checklists by tap-holding on the far right and dragging them up or down, and delete a checklist by tapping the minus button on the left and then tapping Delete. You can also delete checklists without entering Edit mode using swipe-delete.

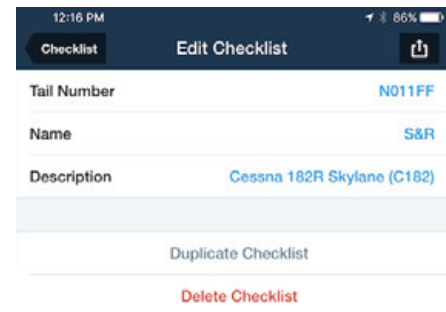

After tapping into a checklist, tap the Edit button to edit either the lists or subgroups within a given group (Normal, Abnormal, or Emergency). When editing subgroups you can change their names, re-order them, or delete them, and add new subgroups using the black button at the bottom of the screen. When editing lists you can change their names, change the group they’re in, or change the subgroup they’re in (which is based on which group they’re in). You can also re-order and delete lists, and add new lists using the button at the bottom of the screen.

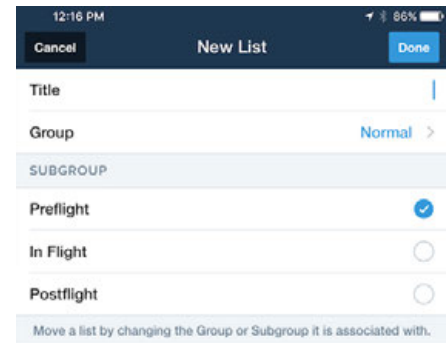

Tap Edit while viewing a list to make edits to it. Tap Edit on a check item to change its “Challenge” or “Response”, and add optional notes that will appear at the bottom of the check item.

Tap Edit on a detail item (used to separate check items and provide information not associated with a check item) to change its title and text. Create new detail and check items using the buttons at the bottom of the screen and delete or re-order as on the other pages.

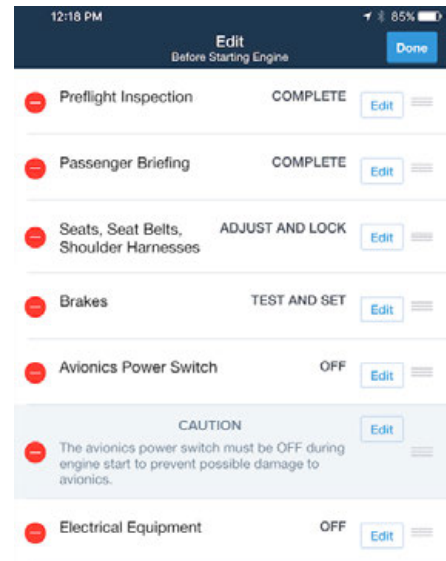
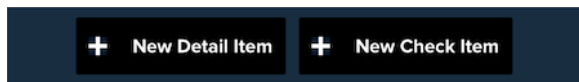

Using Checklists

After setting up and editing a new checklist so that it matches your POH, using it is very straightforward.

Tap into a checklist and tap on a list to start using it. Use the Check and Skip buttons at the bottom of screen to check or skip check items, or tap directly on an item to check it. When you check an item, the empty circle on the left turns green with a checkmark; when you skip an item, the circle turns yellow. As you check or skip items, the selection indicator advances down the list, allowing you to move through an entire list using only those two buttons. You can clear a checked or skipped item by tapping on it, allowing you to quickly check off previously skipped items, or clear items that you want to re-check.

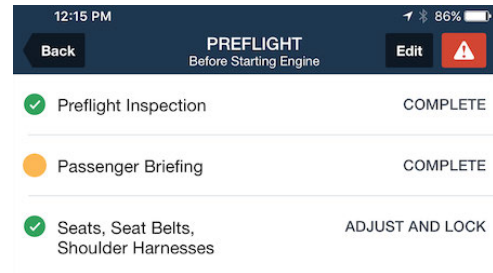

Once you’ve checked or skipped every item in a list, a blue Next button replaces the Skip and Check buttons at the bottom of the screen, allowing you to jump straight into the next list.

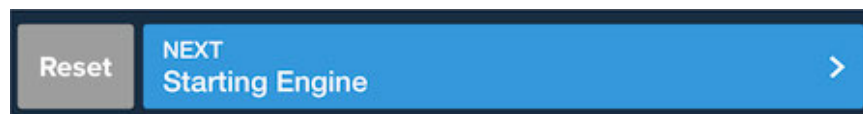

Use the Reset button in the lower-left corner of a list to clear all items within that list. The Reset button can also be used when viewing a checklist to clear every list within that checklist. **NOTE:** Resetting a checklist also clears lists in other groups that you can't see from the group you're in.

If you tap the Back button in the upper-left to leave a list before completing it, your progress in that list is indicated by a circle that fills in as you complete more of the list. Once fully completed the list is marked with a check.

The red Emergency button in the top-right is available on every page within a checklist for quick access. Tapping it will place you directly into the Emergency list group, allowing you to select and begin using one of the emergency lists.

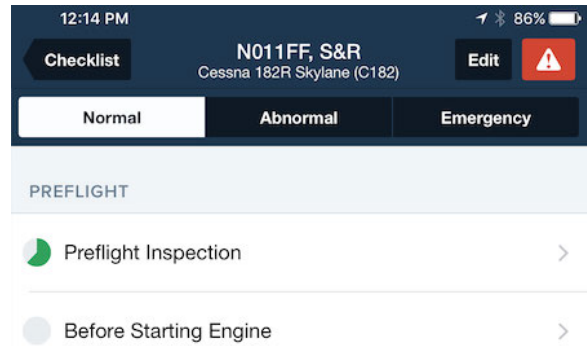

Sharing Checklists

From the main Checklist view, tap the Send To button at the bottom of the screen. Tap on the checklist that you want to share and tap the Share button in the upper-right. Tap on a nearby iPad's/iPhone's name to share it with AirDrop, or tap Mail (or another email app) to create a new email draft with the checklist's file attached.

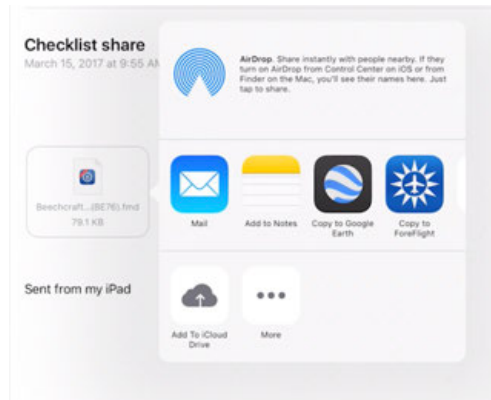
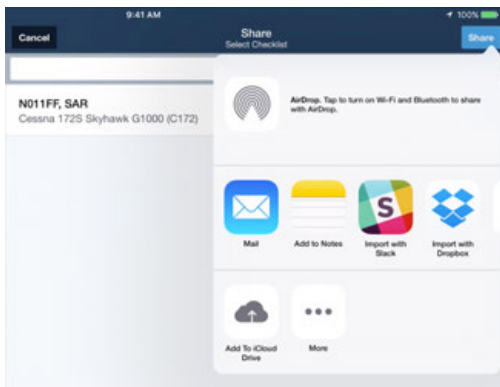

Checklists received via AirDrop will automatically be imported into ForeFlight Mobile, which will open and jump to the Checklist view so you can see the new checklist. If you receive an email with an attached checklist, tap on the attachment and tap "Copy to ForeFlight" to import the checklist and open ForeFlight to the Checklist view.

Checklist files can only be opened and edited within ForeFlight.

Weight & Balance

The Weight & Balance feature allows you to quickly determine whether your aircraft is loaded within its envelope, an important part of every pre-flight. It is included in the Basic Plus, Pro, and Pro Plus plans for individuals, as well as the Business Pro plan for multi-pilot business subscribers.

The Weight & Balance feature can be used for **fixed-wing** aircraft that meet these requirements:

- ❖ **Constant weight limits (i.e., weight limits do not vary with CG)**
- ❖ **CG is in length units, not %MAC**
- ❖ **Takeoff and Landing CG limit envelopes are the same**
- ❖ **Only 1 fuel moment table (i.e., a single variable-arm fuel station)**

Weight & Balance includes the SmartOptions™ interview, which uses data from Type Certificates to allow you to answer a few questions to quickly set up your aircraft's W&B profile based on its tail number and the empty weight, moment, and CG from the POH.

The SmartOptions™ interview is available for many popular Cessna, Cirrus, Diamond, Mooney, and Piper aircraft.

Once your aircraft's W&B profile is set-up, you can quickly create a Loading Summary for each flight, and you can share the profile and a PDF copy of the Loading Summary via email. W&B profiles are automatically [synced](#) between your devices when Synchronize User Data is enabled in More > Settings.

For full details, see the **Weight & Balance in ForeFlight Mobile** guide in Documents > Catalog > ForeFlight, or at www.foreflight.com/support.

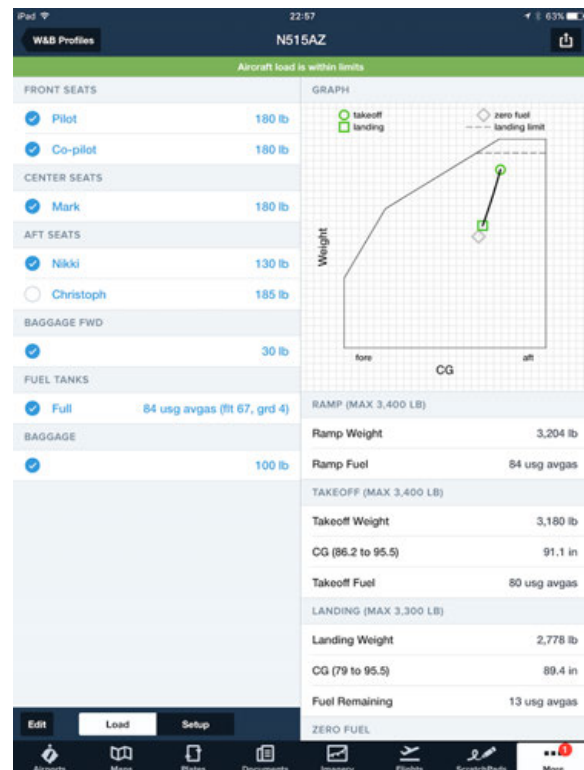

Settings

ForeFlight Mobile supports a variety of settings to let you customize how you like to use and view your data. Settings are changed in the *More* view or the main **Settings** application on the iPad.

All settings will be reset to their default values if you uninstall ForeFlight Mobile.

❖ **Brightness Slider** - integrates with the iPad's brightness slider, but allows for additional dimming if the lowest setting of the iPad's slider is not dark enough.

❖ **App Theme** - sets the app's overall color scheme to a "Light" color (same as prior app versions) and new "Dark" color, ideal for flying at night.

Airport View

❖ **Show Weather First** - turn *ON* to show the METAR view first when viewing an airport. Turn *off* to see that last-viewed data category first.

Weather View

❖ **Past TAF Translations** - turn *ON* to see expired TAF forecast time periods in the weather view. Turn *OFF* to hide expired TAF forecast periods.

Route View

❖ **Airway Decoding** - set to *Bends Only* to filter out airway intersections that do not cause a course change. VORs and NDBs will always be shown in an airway.

❖ **Airway Entry/Exit** - select Any Waypoint or Radio Nav aids Only for auto routing from the "Routes" button in the Flight Plan Editor.

Map View

❖ **Auto Center Mode** - select Track Up, Track Up Forward, or North Up.

❖ **Auto Center Deactivate** - select from automatic (auto center mode will turn off the instant you manually pan or zoom the map) or manual (the auto center crosshair button must be pressed to disable auto center mode).

❖ **Extended Centerlines** - turn *ON* to see extended runway centerlines for airports in the current route. Centerlines extend 5 NM from runway end.

❖ **Distance Rings** - turn *ON* to show 3 concentric rings centered around your aircraft's location, in the the style selected in Distance Rings Style.

❖ **Distance Rings Style** - choose between: Distance-based - Automatic (Distance), which changes the NM scale of the rings as you zoom in and out on the Maps; 5, 10, 25 NM; or 10, 20, 50 NM; or 20, 40, 100 NM; or Time-based - Automatic

(Time), which changes the time scale of the rings as you zoom in and out on the map; 5, 10, 30 minutes; or 10, 20, 60 minutes.

❖ **Track Vector** - turn *ON* to display a vector in front of your aircraft's icon.

❖ **Track Vector Length** - tap to select the length of the track vector: 15, 30, 45, 60 seconds; 2, 5, 10 minutes; 1/2, 1, 2, 5, 10, 25, 50 Nautical Miles.

❖ **Profile Corridor Width** - total width of the profile corridor; obstacles and terrain within the corridor are shown in the Profile view: 1/2, 1, 2, 4, 6, 8, 20 Nautical Miles wide.

❖ **Route Labels** - turn *ON* to see labels on route waypoints on Map. When *ON*, these labels will each hide/show to prevent overlapping with each other.

❖ **Nav Log Columns** - select columns to display in NavLog on Maps page: Totals Only, Leg only or Both (default).

❖ **Current Location Marker** - select an image to be used on *Maps* view to show your current location when in motion.

❖ **Initial Map** - whether the last-viewed map should be shown when the app starts, or a different base map.

❖ **Hazard Advisor** - select minimum groundspeed for Hazard Advisor layer to be active when it is selected on Maps.

❖ **Hazard Altitudes** - altitudes for the Red and Yellow colors in Hazard Advisor and Profile view. First number is the altitude below the aircraft for the Red color (also includes above current altitude), 2nd number is the altitude below the aircraft for the Yellow color: Normal (100'/1000'); Heli - Normal (50'/300'); Heli - Medium (25'/200'); Heli - Low (25'/100').

❖ **Map Touch Action - No Action**: charts are seamlessly stitched together; **Bring chart to front**: single-tap on a chart to bring it forward, covering any adjacent overlapping charts; **Bring chart to front with legends**: same behavior as **Bring chart to front** but also displays the frontmost chart's legend and borders.

❖ **Four-color Radar** - turn *ON* to display radar in a low resolution, four-color scheme that complies with dBZ-to-color mapping standards defined by the Radio Technical Commission for Aeronautics. See [Radar Legends](#) for more information.

❖ **Cockpit Sharing** - turn *ON* to allow sharing routes between devices running ForeFlight Mobile on the same WiFi network.

❖ **Show Annotations on Map** - turn *ON* to show plate or airport diagram annotations when displaying a Plate or Airport Diagram on the Map.

❖ **Auto-Receive Panel Flight Plans** - turn *ON* to automatically load new routes received from a Garmin Connex connected panel to your Route Editor. Turn *OFF* to receive a notification when a new route is available and manually load it.

Plate and Document Views

❖ **Lock Disables Buttons** - turn *ON* to disable all buttons on Plates and Documents views when lock button is bright blue in top toolbar. This will also disable the bottom buttons that are used to change to other views like Airports, Maps, etc.

Traffic

❖ **Hide Distant Traffic** (when connected to a Stratus ADS-B receiver) - turn this *ON* to hide traffic more than 15NM from your current GPS location and/or more than 3,500' above or below your current GPS altitude.

Search and Rescue

❖ **Enable Search and Rescue** - turn *ON* to enable the SAR grid layers and SAR patterns (iPad only). See Search and Rescue Supplement, available in **Documents** > **Catalog** > **ForeFlight**. SAR features are accessed via the Procedure Preview.

❖ **SAR Waypoints as Lat/Lon** (iPad only) - turn *ON* to display the waypoint labels in a SAR pattern as Latitude/Longitude, instead of SAR-01, SAR-02, etc...

Pack

❖ **Enable Auto-Check** - turn *ON* to have Pack automatically check whether downloads are needed prior to the flight. Turn *OFF* to only activate Pack by tapping the Pack "suitcase" button at the bottom of the Flight Plan Editor.

Track Log

❖ **Enable Start/Stop Control** - turn *ON* to show the Track Log "REC" button and the Track Log timer in the bottom-left of the Maps view. Starting or stopping a Track Log by tapping the REC button overrides the Track Log auto start/stop functionality, if that setting is enabled.

❖ **Enable Auto Start/Stop** - turn *ON* to automatically record Track Logs without tapping the REC button.

File & Brief

❖ **New Plan Format** - *Same as Last Filed, ICAO, or FAA/Domestic*: lets you choose the default type of plan that will be created when you tap the "Proceed to File" button on the Flights page. An individual flight plan type can be changed while creating the flight plan on the "Proceed to File" page.

❖ **ForeFlight Briefing** - turn *ON* to use ForeFlight Briefing when requesting a weather briefing from Flights. Turn *OFF* to use the legacy text briefing instead.

Taxi Diagram

❖ **Auto Show Taxi** - turn *ON* to automatically switch to the current airport's taxi diagram, when available, upon landing.

❖ **Show Taxi on Map** - turn *ON* to show the automatically-displayed taxi diagram overlaid on the Maps page; turn *OFF* to show on the Plates page.

Preferences

❖ **Alerts** - adjust settings related to in-app alerts. See [Alerts](#) for more information about each alert.

❖ **Speak All Alerts** - turn *ON* to receive audio alerts via your device's speaker or a connected headset for all active alerts in ForeFlight. When toggled *ON* a confirmation message is played; use the iPad/iPhone volume buttons to adjust volume. **NOTE:** TFR and Traffic alerts will not play audio when ForeFlight detects that you are below 250' AGL, even if Speak All Alerts is enabled.

General

❖ **500' AGL Alerts** - turn *ON* to receive an alert when your aircraft descends past 500' AGL.

❖ **Cabin Altitude Alerts** (requires iPad/iPhone or external device equipped with barometric sensor) - turn *ON* to receive alerts when your aircraft passes 12,000' MSL and 25,000' MSL.

❖ **Runway Proximity Alerts** - turn *ON* to receive alerts when nearing or entering a runway.

❖ **Sink Rate Alerts** - turn *ON* to receive an alert when your descending vertical speed becomes excessive (-4,000' per minute above 2,500' AGL, -3,000' per minute at 2,500' AGL, down to -1,500' per minute at 500' AGL).

❖ **Traffic Alerts** - turn *ON* to receive an alert when traffic is within 1.8 NM and +/- 1,200' GPS altitude of your aircraft's current position. **NOTE:** Traffic audio alerts are only issued when ADS-B Out is detected in your aircraft.

Devices

❖ **Device Disconnect** - turn *ON* to receive an alert when a connected Wi-Fi or Bluetooth device disconnects from ForeFlight abruptly.

❖ **Flight Plan Auto Update** - turn *ON* to receive an alert when a connected panel device automatically loads a flight plan into ForeFlight's Route Editor. Requires that the "**Auto-Receive Panel Flight Plans**" settings is enabled.

Route-Based

❖ **Destination WX Frequency Alerts** - turn *ON* to receive a callout with your destination airport's weather frequency as you near the airport.

TFRs

❖ **TFR Alerts** - turn *ON* to receive alerts when you are approaching or near a TFR.

❖ **Include DC SFRA/FRZ** - turn *OFF* to prevent ForeFlight from issuing TFR alerts for Washington DC's Special Flight Rules Area and Flight Restricted Zone. Other TFRs within the SFRA/FRZ (e.g. stadium TFRs) will still trigger alerts when this setting is *OFF* - only the SFRA/FRZ are affected by it. Pilots are encouraged to leave this setting *ON* unless they regularly fly through the SFRA/FRZ.

❖ **Altitude Buffer** - height in feet added above and below TFRs that determines whether an alert is displayed based on your altitude relative to the TFR. For example, approaching a TFR whose top is 4,000' below your current altitude will trigger an alert if the altitude buffer is set to 5,000', but will not trigger an alert if the altitude buffer is set to a smaller height. Available buffers are 500', 1,000', 2,000', and 5,000'.

❖ **Units/Time** - menu containing the following settings:

❖ **Show Local Times** - turn *ON* to see times in the local time zone. Turn *off* to see times in Zulu time.

❖ **Wind Speed** - select preferred units.

❖ **Pressure** - select preferred units.

❖ **Temperature** - select preferred units.

❖ **Visibility** - select preferred units.

❖ **Coordinates** - select preferred units for viewing coordinates.

• **DD.dd**[°] - degrees and hundredths of degrees.

• **DD[°]MM.mm** - degrees, minutes, and hundredths of minutes.

• **DD[°]MM'SS"** - degrees, minutes, and seconds.

- **MGRS 6-/8-/10-digit** - Military Grid Reference System with three precision levels (more digits equates to greater precision).
- ❖ **Aircraft Speed** - select preferred units for airspeed and groundspeed.
- ❖ **Distance** - select preferred units for distance.
- ❖ **Runway Length** - select preferred units for runway lengths.
- ❖ **Allow Device to Sleep** - turn *ON* to allow your device to sleep while running ForeFlight Mobile, including when on Plates view or when downloading data. Turn *OFF* to ensure that the iPad will not enter sleep mode while ForeFlight Mobile is running in the foreground, even if your iPad is set to usually sleep after a certain period of inactivity.
- ❖ **Automatic Clock Check** - turn *ON* to automatically verify that your iPad's system time is set correctly. If it is found to be incorrect, you will get an alert. Proper system time is important for many features in the app.
- ❖ **Confirm Before Dial** (iPhone only) - turn *ON* to display a pop-up when you tap on a phone number so you can confirm that you want to call the number.
- ❖ **Enable Ownship** - **ALWAYS**: shows your aircraft position on charts, and with ForeFlight Mobile Pro, on approach plates and airport diagrams; **NEVER**: your aircraft position is not shown on any chart or plate. This is required for certain operators; **LIMITED**: with ForeFlight Mobile Pro, shows your aircraft position on the airport diagram when your speed is under 80 knots; above 80 knots, or when GPS location accuracy degrades below the requirements in AC-120-76C, the aircraft position will not be shown.
- ❖ **Show Heliports** - turn *ON* to view heliports in nearby airports lists. You can always search for heliports (and use them in routes) regardless of this setting.
- ❖ **Show Private Airports** - turn *ON* to see private airports in nearby airports lists. Private Airports include any airport not open to the public, including Military airports.
- ❖ **Start on Last Screen** - turn *OFF* to start on the *Airports* view on next launch. This can help if one view is causing the application to quit immediately after launch.
- ❖ **Extra Keyboard Keys** - turn *OFF* to hide the row of numbers 0-9 shown above the regular keyboard. When *OFF*, 0-9 are still accessible using the “.?123” key in the lower-left of the keyboard.
- ❖ **Synchronize User Data** - turn *ON* to synchronize user data automatically between devices via the cloud. See [Sync](#) for details.

❖ **Enable Diagnostic Logs** - turn *ON* to record diagnostic information as you download chart data. This information can then be sent to the ForeFlight Pilot Support Team to help troubleshoot problems you may be having downloading data.

❖ **Performance Logging Level** - used to diagnose issues with app performance. Do not set this to anything other than zero unless instructed by a ForeFlight support team member as it may negatively impact healthy app performance.

User Content

The User Content tab is where you can manage custom user content that you've created or imported into the app, including User Charts (.mbtiles files), User Map Layers (.kml files), and User Waypoints (.kml or .csv files).

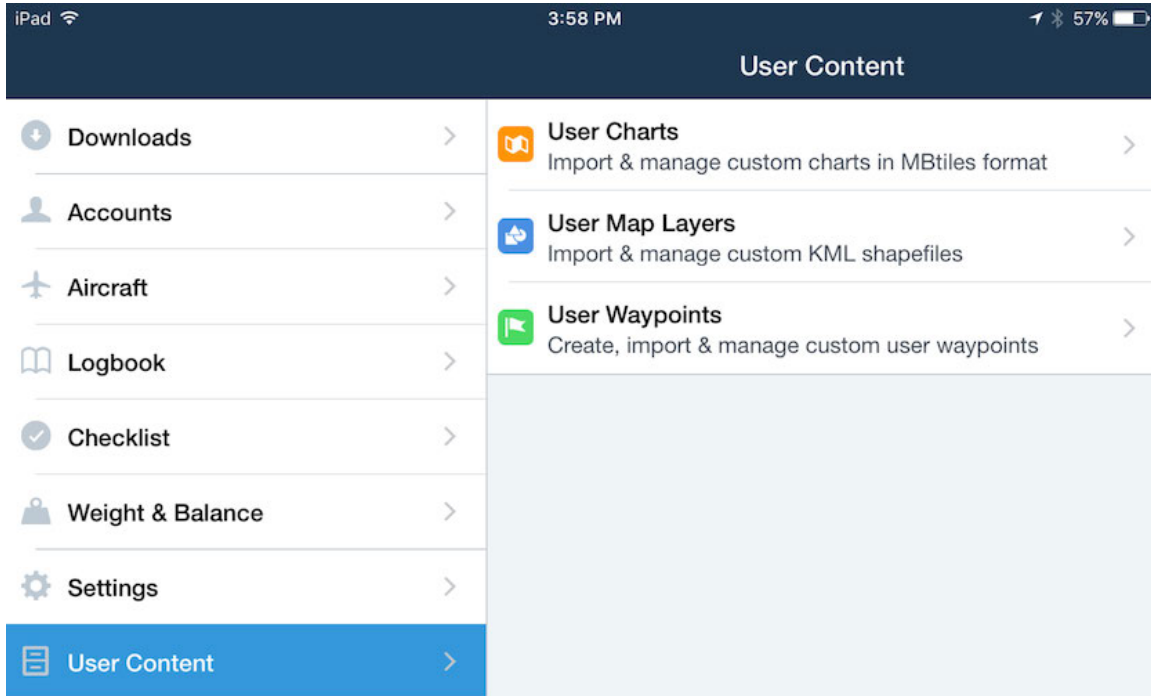

Importing User Content files

User Content files (other than .csv User Waypoint files) can be directly imported into ForeFlight from the Apple Mail app, a browser, or the Dropbox app, and they can be sent directly to an iPad or iPhone via AirDrop.

- From Mail, touch-hold on the file...
- From Safari, tap on the file, then tap on "More...";
- From Dropbox, tap the 3 dots button in the upper-right, tap Export, then tap Open In...;

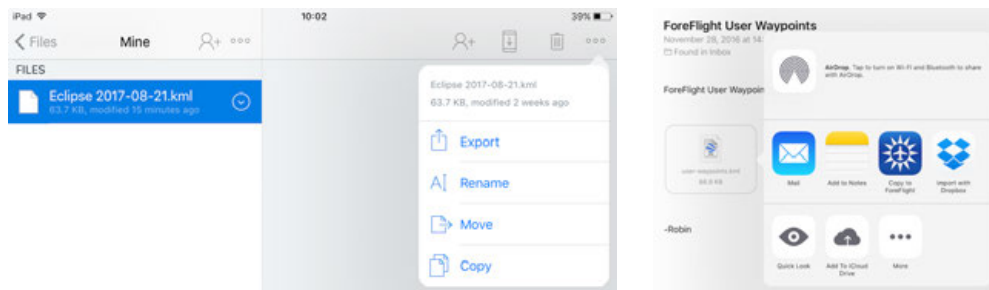

Then tap “Copy to ForeFlight” in the popup.

If an imported KML file contains user waypoints, a pop-up will open so you can choose whether to import the points as User Waypoints or as a User Map Layer. Importing new user waypoints does not delete any user waypoints that are already in ForeFlight, unless they have the same name (e.g. “HOME”), in which case the new waypoint will replace the original.

To import a file using AirDrop from a Mac, right-click on the file then choose AirDrop.

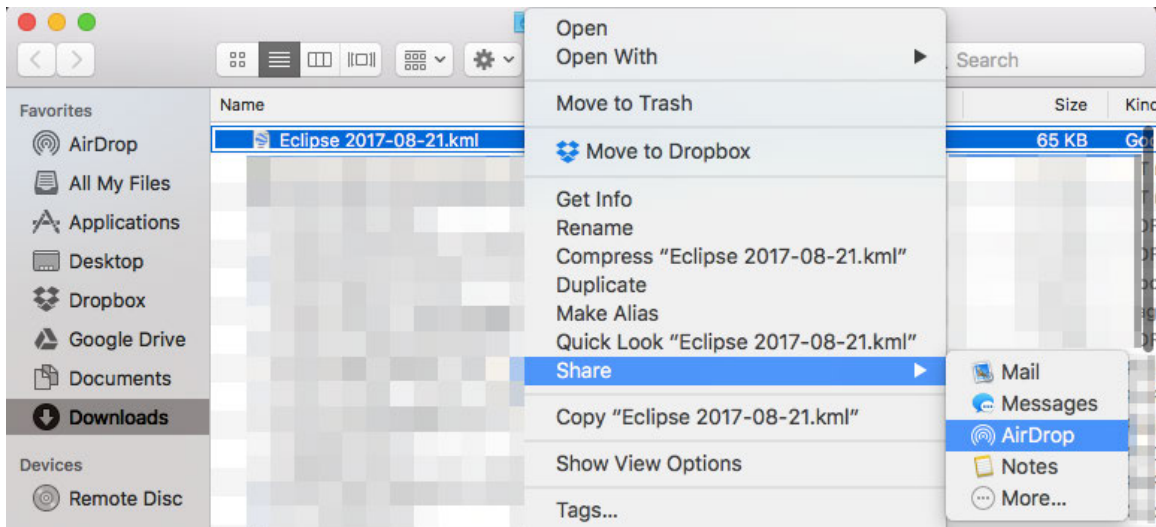

A pop-up will open showing all available iOS devices. If yours does not show-up, open the System Tray by swiping-up from the bottom and turn Air Drop Receiving ON. When you find your device, tap it to begin the file transfer. On your iOS device you will see a pop-up asking with which app the file should be opened. Tap ForeFlight.

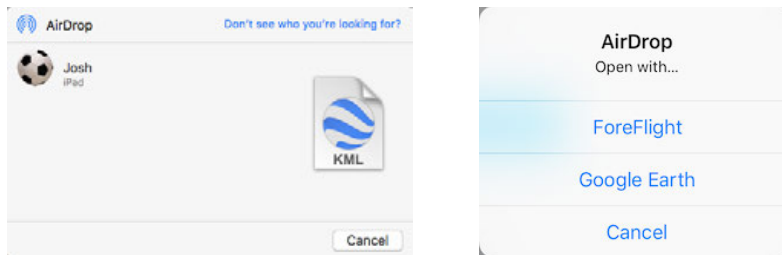

User Content files can all also be imported by connecting the device to a laptop or desktop computer running iTunes:

Open iTunes, then plug-in the device. Click on the device icon, click on Apps in the left-hand menu, then scroll the page down to the File Sharing section. Click on ForeFlight in the left Apps menu, then drag the file(s) into the “ForeFlight Documents” section on the right. See <https://foreflight.com/support/user-content/> for additional details about importing using iTunes.

Deleting User Content

Tap on the appropriate category, swipe from right to left across the item you want to delete, and tap the red Delete button. You can also tap the “Edit” button in the top-right to delete individual items or to delete all files in that category.

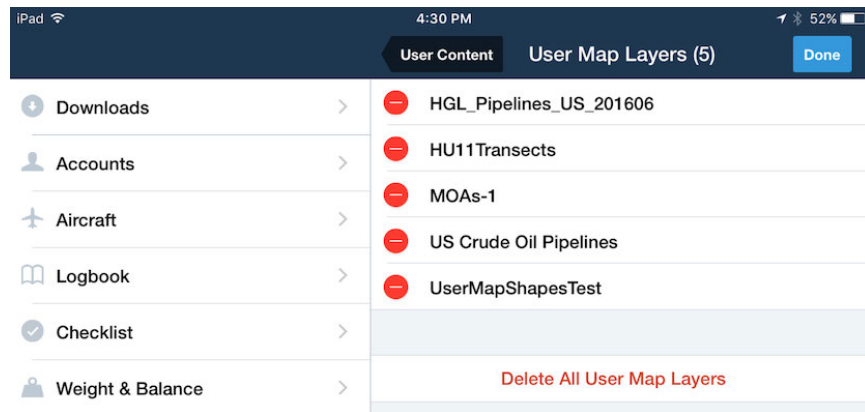

Sharing User Waypoints

You can export your user waypoints as a KML file and send them via email. Tap the Send To button in the bottom left of the User Waypoints page and tap Mail to create a draft email with the KML file attached. **NOTE:** You must have an email account set up in your device’s Apple Mail app for the mail option to appear.

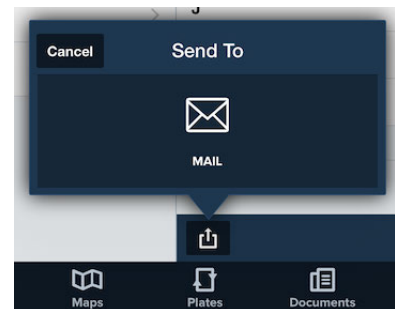

Creating User Waypoints

User Waypoints can be created by touch-holding a location in the Maps view. To create a User Waypoint, tap-hold the point when you want to create a waypoint until the pop-up is displayed. Tap the More button next to the Lat/Lon coordinates, then tap the **Save** button to create and name the waypoint.

❖ **Name:** Create a recognizable name for the waypoint. Names must be at least 3 characters long, all one word with no spaces, and must contain at least one letter. Once a waypoint has been named, you'll be able to reference it while creating routes just as you would any other waypoint.

❖ **Description:** Provide a brief description of the waypoint. The description appears in the waypoint callout when you tap that waypoint in your route in the Maps view.

❖ **Lat/Lon:** When creating a user waypoint via touch-planning, the latitude and longitude are determined for you based on the point on the map that you touch. Lat/Lon coordinates can be entered in [4 different formats](#).

Field	Value
Name	Required
Description	
Latitude	34.24638
Longitude	-117.64492

Input formats for example longitude
80°45'57"W:
80.766W
-0804557
W0804557
-08045.95
-08045576

Or type in any Map-supported location in the Latitude field such as KOSH or FKN/320/15

You can also enter a user waypoint as a distance and radial from an aviation point by entering the point/radial/distance information in Latitude and leaving Longitude blank. For example, entering GEP/125/10 in Latitude would create a user waypoint 10 NM away from the GEP VOR on the 125 Radial.

You can also enter a User Waypoint using the MGRS@... format described in the Search & Rescue Supplement, found in Documents > Catalog > ForeFlight. Similar to the point/distance/radial method above, enter the MGRS@ point in Latitude and leave Longitude blank.

To edit an existing user waypoint's details, tap the  button next to the waypoint.

Once the waypoint is created, it functions just as any other waypoint in ForeFlight Mobile.

To **delete** a single user waypoint from your device, tap More > User Waypoints and use the swipe-to-delete gesture: swipe your finger across the name of the

waypoint, then tap the red Delete button. To delete ALL User Waypoints, tap the "Clear" button.

Latitude/Longitude Formats

For input of latitude/longitude in User Waypoints or the Search box on the Maps page, 4 formats are supported:

- ❖ DD.dd
- ❖ DD MM SS
- ❖ DD MM.mm
- ❖ DD MM SSs

Examples of these formats using this location 32°44'55.6"N, 80°45'57.6"W are:

- ❖ DD.dd 32.75N/080.77W
- ❖ DD MM SS 324456/-0804558
- ❖ DD MM.mm 3244.93/-08045.96
- ❖ DD MM SSs 3244556/-08045576

NOTES:

- 1) Latitude is always DD, and Longitude is always DDD.
- 2) Include a minus sign for Longitudes west and Latitudes south.
- 3) Regardless of the input form used for a User Waypoint, it is automatically converted to DD.dd format storage.

For reading Airport coordinates and ad-hoc tap-and-add coordinates ForeFlight allows you to select from 3 formats:

- DD.dd
- DD MM.mm
- DD MM SS

To change formats within ForeFlight Mobile, go to **More > Settings > Units/Time > Coordinates** and select the format you want.

User Map Layers

The User Map Layers feature enables you to import and display custom KML shape files over any map.



Only one KML file can be displayed at a time. All KML files that have been imported are shown in the list on the bottom of the right column in the Map Selection drop-down menu, and in the User Map Layers section of More > User Content. Visit <https://foreflight.com/support/user-content/> to learn more about User Map Layers.

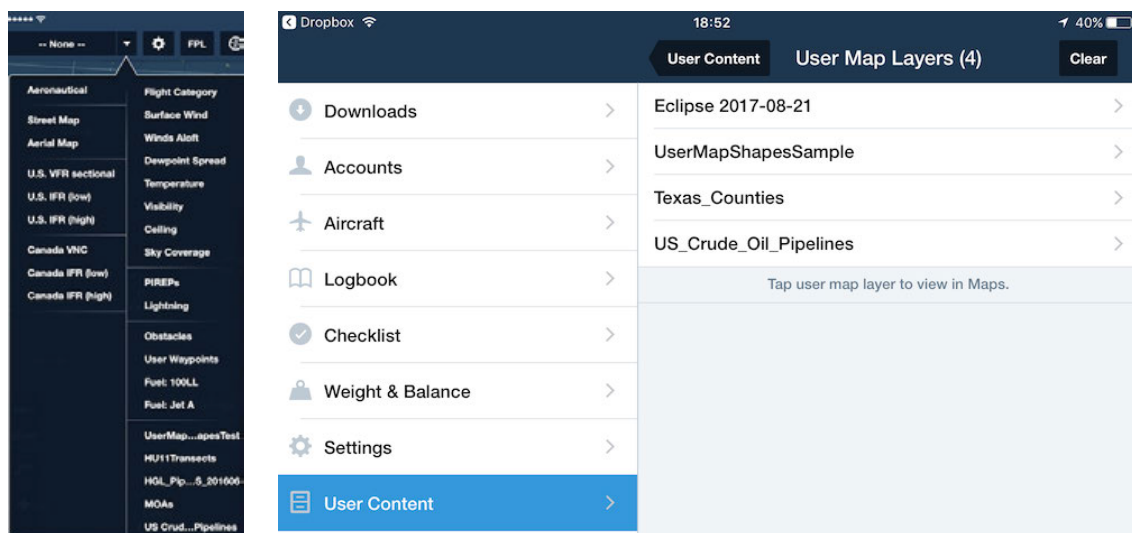

User Charts

The User Charts feature allows you to import custom georeferenced charts in .mbtiles format and display them on the Maps view on top of other charts. Only one user chart can be displayed on the map at a time, but you can display user map layers and user waypoints at the same time as a user chart.



Tap on a user chart in More > User Content to see details about it or display it on the Maps page. Visit <https://foreflight.com/support/user-content/> to learn more about User Charts and how you can add georeferencing data to your own charts for use in ForeFlight Mobile.

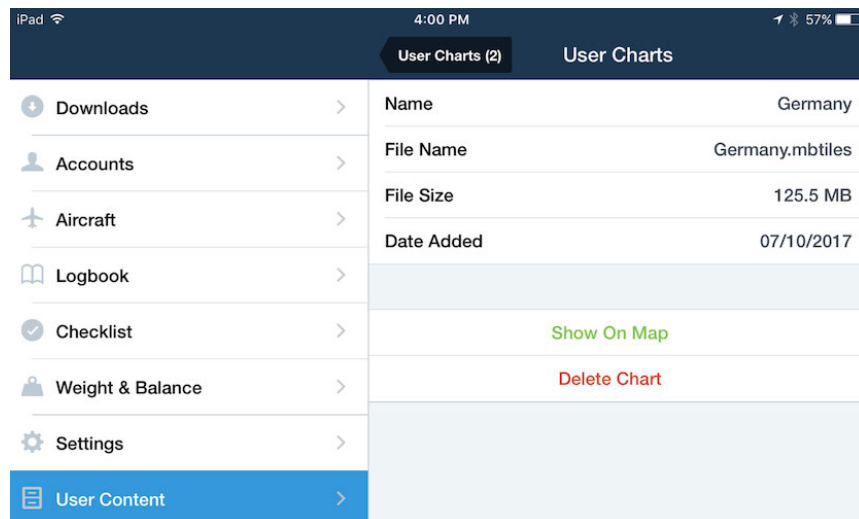

Track Logs

The Track Logs view is where you can view and edit details about recorded Track Logs and export them to your logbook, share them via email, Facebook, or Twitter, or open them in other apps, such as Google Earth and CloudAhoy.

See [Track Logs](#) for more information.

Devices

The Devices view shows any connected devices explicitly supported by ForeFlight. The box for Stratus ADS-B, Baron Mobile Link for XM, and Flight Simulator data connections can be tapped for additional information.

The box for Bluetooth GPSs like the Bad Elf Pro, DUAL, and Garmin GLO indicates that the GPS is connected, but no additional information about the GPS, such as # of satellites or battery % is available. For that information, use the helper app provided by the GPS manufacturer.

Location Disabled / Troubleshooting GPS position issues

Check the following if your GPS position does not show in ForeFlight Mobile or if the “Location Disabled” pop-up displays:

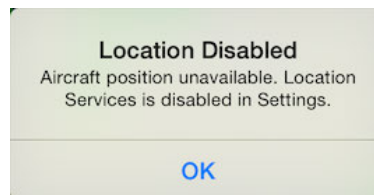

Open Apple Settings, tap **Privacy**, then **Location Services**; or open Apple Settings, scroll down on the left to the list of apps, and tap ForeFlight.

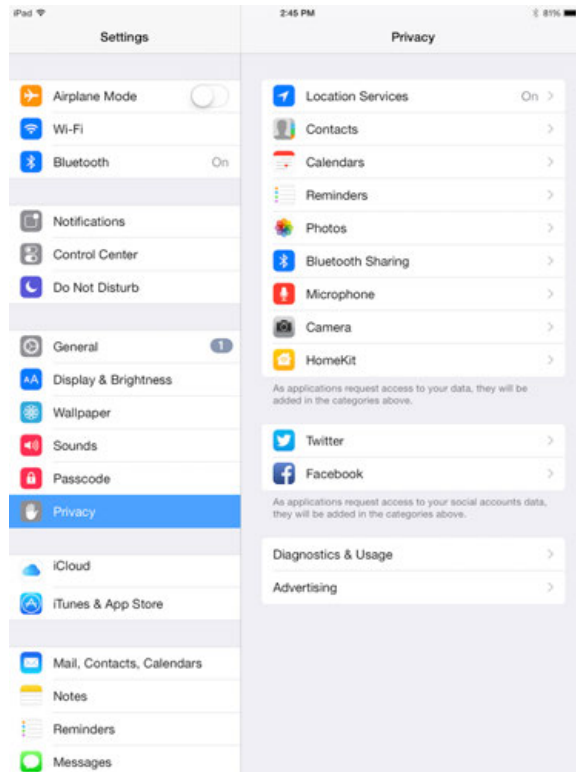

Confirm that Location Services are ON, and the setting for ForeFlight is **Always**.



The recommended setting for ForeFlight is “**Always**” because this allows the app to function as designed if the iPad or iPhone is slept or ForeFlight Mobile is put into the background (eg: so track logs can continue to record). If you choose “While Using the App” there may be a delay updating your position after the app is reopened.

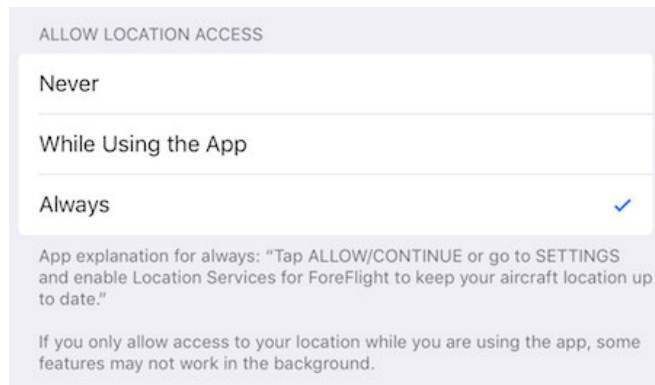

Then open ForeFlight Mobile, tap **More**, then **Settings**. Confirm that Enable Ownship is set to: **Always**.

If these steps do not resolve the issue, contact the ForeFlight Pilot Support Team at team@foreflight.com for assistance.

About

The *About* view provides more information about ForeFlight, LLC as well as version information (at the top of the view).

Jeppesen

ForeFlight allows you to download and view Jeppesen terminal and enroute charts in the mobile app, either by linking an existing Jeppesen chart subscription or by adding Jeppesen charts to your ForeFlight subscription with an online purchase at <https://www.foreflight.com/pricing>.

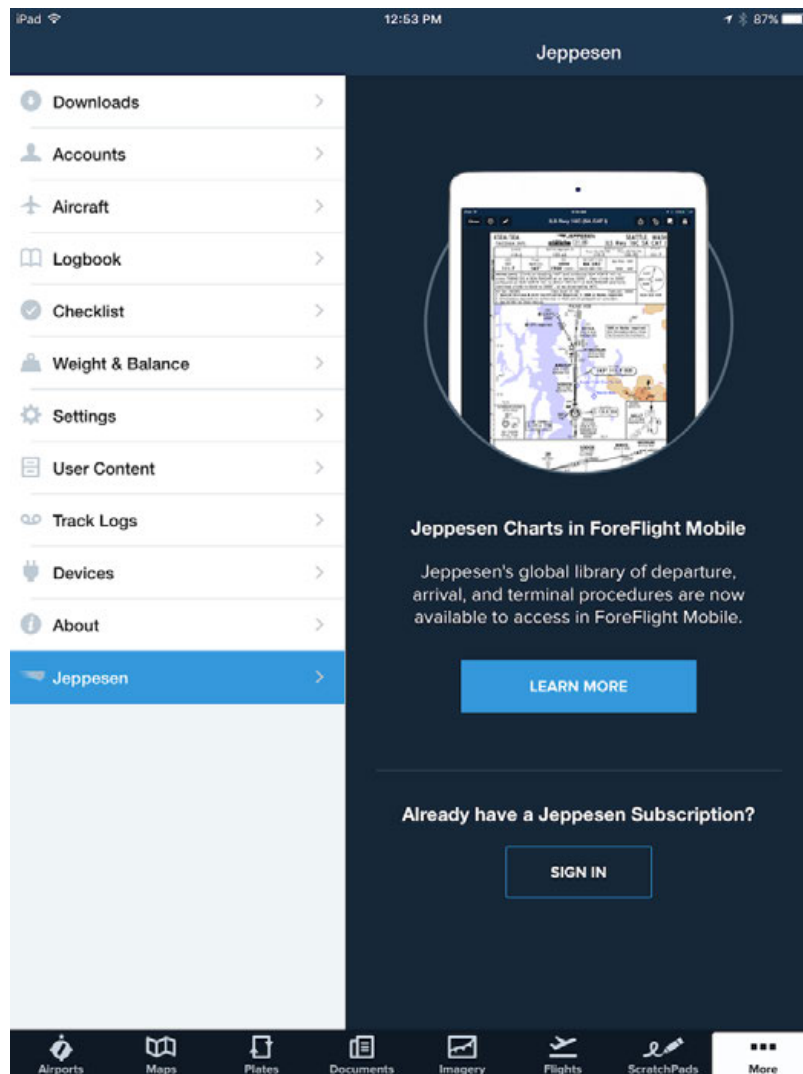

Purchasing Through ForeFlight (single-pilot accounts only)

You can add Jeppesen charts to your ForeFlight subscription in the same way that you would upgrade or renew your subscription. Only single-pilot ForeFlight accounts can add Jeppesen charts this way; if you're the manager of a multi-pilot ForeFlight account and want to add Jeppesen charts, contact Jeppesen by emailing foreflight@jeppesen.com.

Sign into ForeFlight on the web by clicking “Login” in the top-right of [ForeFlight’s homepage](#) and signing into your account. Click the “Account” tab at the bottom of the left-hand navigation bar (the tab will show your first name), and click “Upgrade or Renew my Subscription” next to your subscription name.

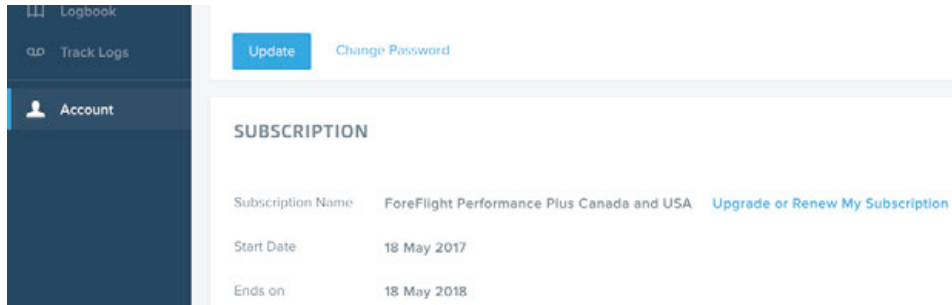

This will take you to ForeFlight’s Buy page where you can select your ForeFlight plan level and selected regions (U.S. and/or Canada), then scroll down and click the “Add Jeppesen Charts” header to expand the list of Jeppesen coverage options. Select the coverage(s) you want to add, then input your credit card information if it isn’t already on file and click “Purchase This Subscription”. If you’re renewing an existing subscription, the remaining time on your account will be converted to a dollar amount and applied to the purchase as credit; this number appears in green on the right, above the total amount.

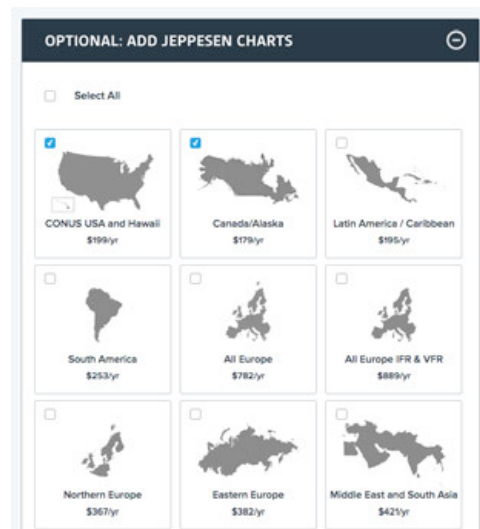

After adding Jeppesen charts to your subscription, the purchase will need to be verified and approved by Jeppesen before terminal charts become available in ForeFlight. This process can take up to 15 minutes, during which a notice will appear on the More > Account view letting you know that your order is being processed. Once processing is complete, two new items will become available for download in the Download view: the global enroute charts and the terminal charts for your coverage.



Once you purchase Jeppesen charts through ForeFlight, the Sign In page on the More > Jeppesen tab will go away, and the page will show your Jeppesen coverages.

Linking an Existing Jeppesen Account in ForeFlight Mobile

If you already have a Jeppesen chart subscription, you can sign into your Jeppesen account in ForeFlight Mobile to access the charts. You can also sign in to your Jeppesen account using ForeFlight’s web application, as explained in the next section.

Go to More > Jeppesen and tap Sign In, then enter your Jeppesen username and password and sign in. You can then select the Jeppesen coverage that you want to activate in ForeFlight. You can only activate one coverage at a time, and you can only activate a coverage if it has “seats” available. The coverage list shows the full name of each coverage, the serial number, the aircraft tail number associated with the coverage (if you specified one when setting up the coverage) and the number of seats available. Tap “Install” to activate a coverage on your device.

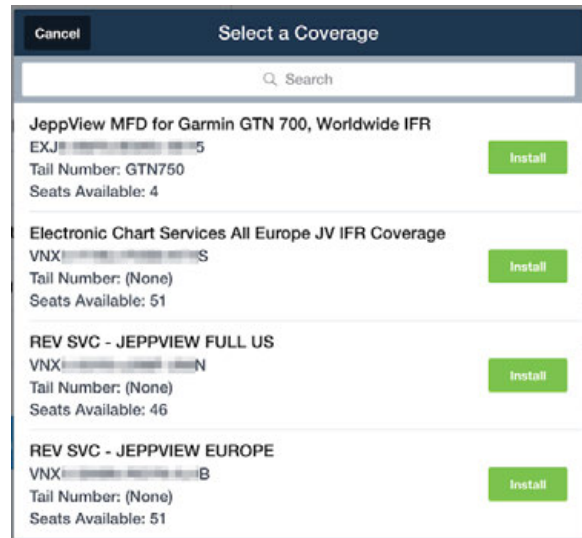

After activating a coverage, ForeFlight will prompt you to begin downloading it. You can tap “Begin Download” to start the download, or tap “Dismiss” to postpone the download until later - this may be preferable if you aren’t on Wi-Fi or don’t have time to complete the download, which can be very large depending on your coverage.

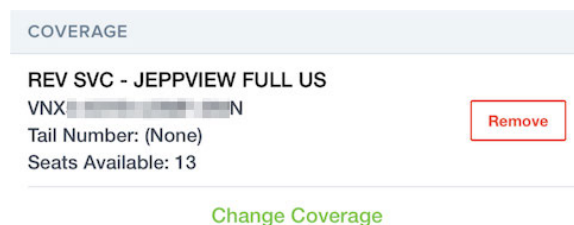
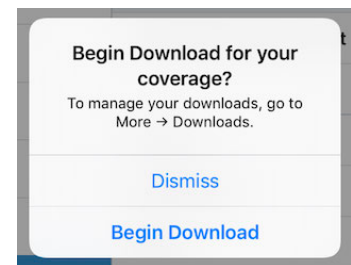

Tap “Remove” to uninstall the current coverage from your device, and tap “Change Coverage” to uninstall the current coverage and activate a different one. Removing the current coverage from your device will also immediately remove the charts you’ve downloaded for that coverage.

Signing into a Jeppesen account on one device will allow you to access the account on all of your other signed-in ForeFlight devices without having to sign in again. If you sign out of your Jeppesen account on any device it will also sign you out of the account on all of your other ForeFlight devices and remove the installed coverages and charts from those devices.

Linking an Existing Jeppesen Account in ForeFlight on the Web

Account managers of multi-pilot ForeFlight accounts can sign in to a Jeppesen account to allow the users on their account to activate coverages and download charts. Account managers can sign in to the Jeppesen account in the mobile app as described above, or on ForeFlight’s web application, which provides management capabilities over the Jeppesen coverages installed by the account’s users.

Sign into ForeFlight on the web by clicking “Login” in the top-right of [ForeFlight’s homepage](#) and signing into your account. Click the “Account” tab at the bottom of the left-hand navigation bar (the tab will show your first name), and click the Jeppesen tab at the top. Click Sign In and enter your Jeppesen username and password. After signing in you can see information about your Jeppesen subscription, coverages, and users who have installed coverages on their devices.

Once the account manager signs into a Jeppesen account, either online or in the mobile app, all of the account’s users will automatically be signed in to the same Jeppesen account on their devices. They can then add coverages included in the account. The account manager can see which users have installed which coverages under the “Installed” section of the Jeppesen tab on the web.

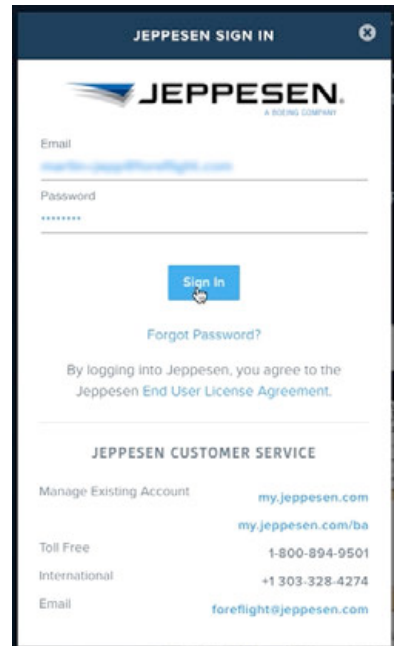

INSTALLED					
Q Search					
DEVICE NAME	PILOT NAME	COVERAGE	SERIAL	TAIL NUMBER	
Sam Taylor's iPad	[REDACTED]	Electronic Chart Services ForeFlight Mobile Single Seat Initial, Electronic Chart Services ForeFlight Mobile Atlantic IFR Coverage, Electronic Chart Services ForeFlight Mobile Europe VFR Coverage	[REDACTED]	N/A	Deactivate

The account manager can also remove coverages from users' devices by clicking "Deactivate" next to the device's name. This will uninstall the coverage and downloaded charts from that user's device, but it will not remove the user from the Jeppesen account itself, allowing the user to immediately install another coverage.

Multi-pilot account users cannot sign in to a Jeppesen account on their own - only the account manager can sign in to a Jeppesen account. Similarly, users cannot sign out of a Jeppesen account on their devices, other than by signing out of their ForeFlight account entirely, but users are free to install and uninstall any coverages provided with the Jeppesen account. If the account manager signs out of the Jeppesen account, all users will also be signed out of the account and have their coverages and downloaded charts removed.

Using Jeppesen Terminal Charts in ForeFlight

After you download Jeppesen terminal charts in ForeFlight they will become available in all the places where you can normally access charts, including the Plates view, Airports view, and Maps view. When viewing a list of procedures at an airport for which you have Jeppesen charts, the Jeppesen terminal charts will appear at the top of the list, while the FAA charts are still accessible further down the list if you want to view them. Jeppesen charts will also become the new defaults in scenarios where ForeFlight will display a terminal chart automatically, such as when showing an airport's taxi diagram by tapping on its bubble in the Route Editor, adding an approach plate using Procedure Advisor, and displaying an airport's taxi diagram automatically upon landing at it.

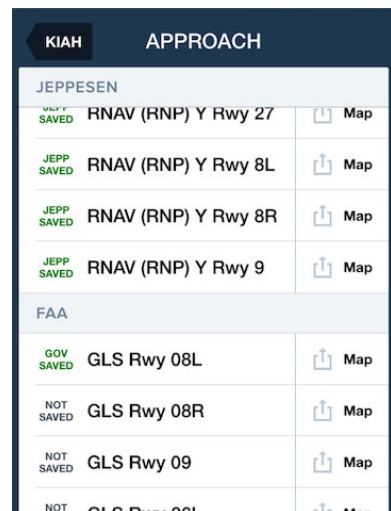

Note: A **Pro** subscription plan or greater is still required to view your position on plates and taxi diagrams, and to overlay plates on the Maps view. If you add Jeppesen terminal charts to a **Basic** or **Basic Plus** plan, they will only be viewable in the Plates view.

Adding Jeppesen coverages in ForeFlight will also allow you to download Jeppesen's airway manuals for all the coverages you have access to. After signing in to your Jeppesen account or adding Jeppesen charts to your ForeFlight subscription, a new "Jeppesen" tab will appear in the Documents Catalog containing the airway manuals available for download.

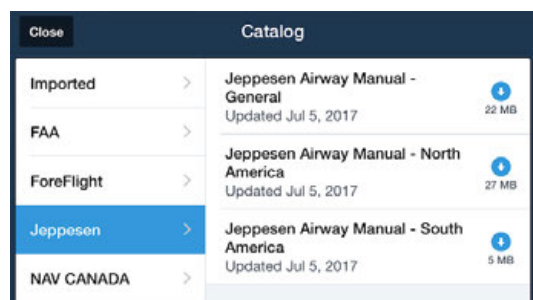

Using Jeppesen Enroute Charts in ForeFlight

Purchasing Jeppesen chart coverage(s) through ForeFlight's website or linking an existing Jeppesen subscription will allow you to download Jeppesen's full set of global VFR and IFR enroute charts, no matter what coverage you have for the terminal charts. The enroute charts will be available in the Maps view layer selector, at the top just under the Aeronautical layer.

Note: Jeppesen enroute charts are not available when using the following devices: iPad Mini 1, iPad 2, iPad 3, and iPhone 5 and earlier.

Like ForeFlight's Aeronautical layer, the Jeppesen enroute charts are data-driven, dynamic, and customizable. Changing the camera position or zoom level of the map will cause the charts to change what is shown and will reposition labels to optimize visibility. Also like the Aeronautical layer, Jeppesen's enroute charts support always-up labels, allowing labels and markers on the map to rotate during track-up flying.

The global enroute charts are also extremely efficient with storage space, with worldwide coverage taking up just over 1GB of disk space after they charts have been downloaded and decompressed.

Enabling any of the Jeppesen enroute chart layers will add new settings to the Map Settings menu, allowing you to change what data is shown for that chart layer. The selections you make only apply to the currently-selected layer, so you can mix and match the map settings for each Jeppesen enroute chart type to optimize the appearance of each one.

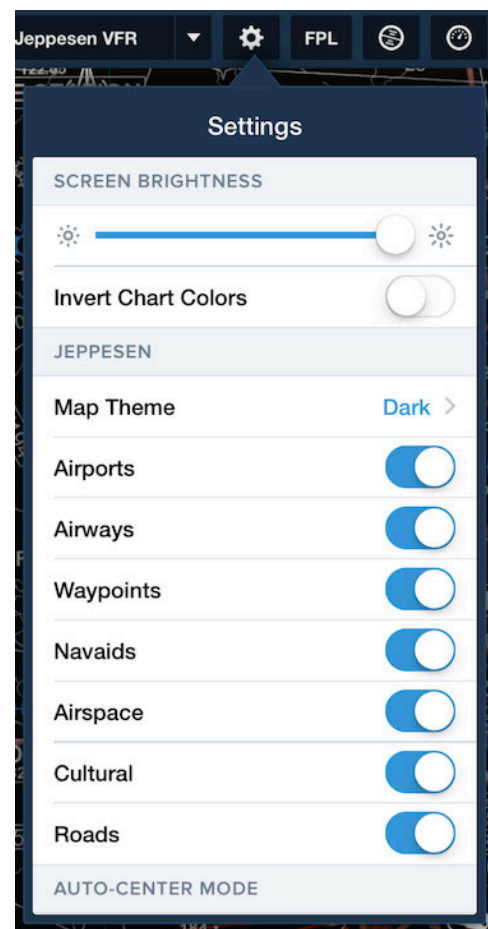
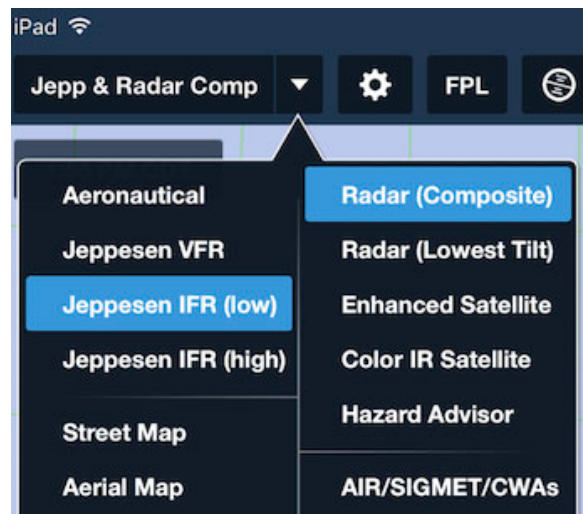

The following table lists the map settings available with each Jeppesen enroute chart type and what they do.

	Jeppesen VFR	Jeppesen IFR (low)	Jeppesen IFR (high)
Map Theme	Choose between a Light and Dark map theme. The Dark Theme inverts black and white while preserving other colors, similar to ForeFlight's Invert Chart Colors switch. Unlike the other settings listed here, this setting is preserved between different chart types.		
Airports	Show or hide airport markers and labels, including private airports and helipads. Zooming into large airports will reveal their runway configuration.	Show or hide airport markers and labels, not including private airports and helipads. Zooming into large airports will reveal their runway configuration.	Show or hide airport markers and labels, not including private airports and helipads. Zooming into large airports will reveal their runway configuration.
Airways	Show or hide VFR corridors and IFR low airways, including labels, MEAs, MOCAs, and radials from navaids.	Show or hide IFR low airways, including labels, MEAs, MOCAs, and radials from navaids.	Show or hide IFR high airways, including labels, altitudes and radials from navaids.
Waypoints	Show or hide VFR waypoints and IFR low waypoints.	Show or hide IFR low waypoints.	Show or hide IFR high waypoints.
Nav aids	Show or hide navigation aids and labels, including NDBs, VOR-TACANs, and VOR-DMEs.	Show or hide navigation aids and labels, including NDBs, VOR-TACANs, and VOR-DMEs.	Show or hide navigation aids and labels, including VOR-TACANs and VOR-DMEs.

Airspace	Show or hide airspace boundaries and labels, including controlled airspace, Mode C, MOAs, SUAs, ADIZ, FIRs, and radio frequencies.	Show or hide airspace boundaries and labels, including controlled airspace, MOAs, SUAs, ADIZ, FIRs, and radio frequencies.	Show or hide airspace boundaries and labels, including SUAs, ADIZ, FIRs, and radio frequencies.
Cultural	Show or hide cultural information and labels, including spot elevations, urban areas, railway lines, parachute jumping areas and magnetic longitude lines.	N/A	N/A
Roads	Show or hide major highways, roads, and streets.	N/A	N/A

Apple Watch

Overview

Apple Watch interfaces with ForeFlight Mobile on your iPhone to provide easily accessible information on current weather and flight data. Raise your arm to awaken the watch, then tap the ForeFlight icon to open the app. The app contains an optional glance page, as well as three primary pages: Airports, Instruments, and Timers. Move between the pages by swiping sideways.



Setting Up

Apple Watch can only be used with an iPhone running iOS 8.2 or later.

Tap the Apple Watch icon on your iPhone's home screen to display a list of apps that have extensions on the Watch, and tap ForeFlight to open the options page for ForeFlight on the Watch.

Show App on Apple Watch - turn ON to enable ForeFlight's extension on the Watch. This setting is turned on by default.

Show in Glances - turn ON to enable ForeFlight's glance page on the Watch. This setting is turned off by default.

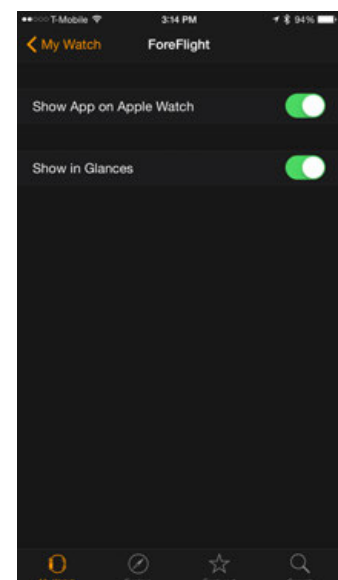
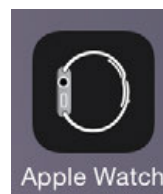

The ForeFlight icon will appear on your Watch face if you have installed ForeFlight Mobile version 7.0 or later on your iPhone and have paired your Watch with your iPhone.

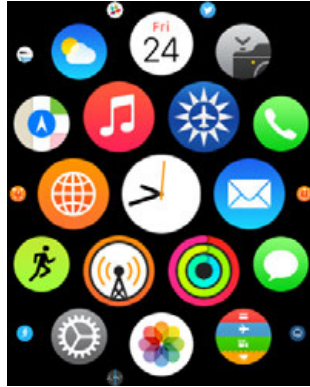

Airports Page

The Airports page displays the flight conditions at up to 30 airports: the ten nearest airports to your position (NBY), your ten most recently viewed airports (REC), and your top ten favorite airports (FAV). You can select which group of airports to view by tapping the bar at the top of the screen. The color coding is the same as on other ForeFlight devices:

Green	VFR: Ceiling greater than 3,000' and visibility greater than 5 miles; includes sky clear
Blue	MVFR: Ceiling 1,000' to 3,000' and/or visibility 3 to 5 miles inclusive.
Red	IFR: Ceiling 500' to less than 1,000' and/or visibility 1 to less than 3 miles.
Magenta	LIFR: Ceiling less than 500' and/or visibility less than 1 mile.

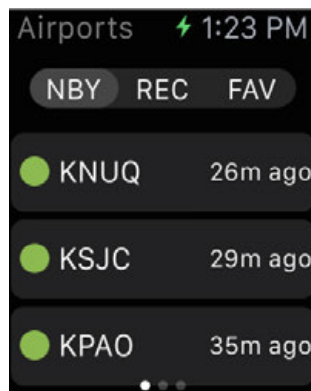

Next to the airport name is the time since the weather information was updated, based on the latest METAR.

Tapping on an airport brings up more detailed weather information, including surface winds, visibility, cloud cover, temperature, altimeter, and weather warnings, if present.

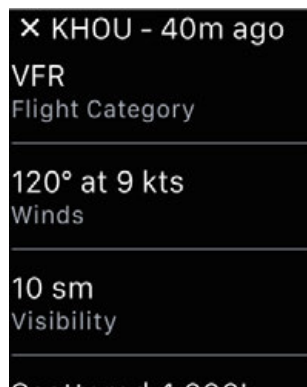

Instruments Page

The instruments page displays flight information that is normally accessible via the app's Instrument Panel. Three instruments can be displayed at once.

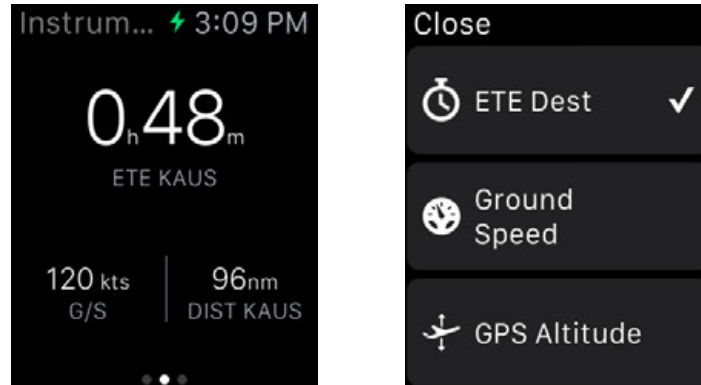

Tapping on an instrument will bring up a menu showing all available instruments, each of which can be tapped on to replace the current one. A checkmark indicates which instrument is currently selected for that slot.

The available instruments are:

- ❖ ETA Next (estimated time of arrival at next waypoint)
- ❖ Dist Next (distance in nm to next waypoint)
- ❖ ETE Next (estimated time enroute to next waypoint)
- ❖ ETA Dest (estimated time of arrival at destination)
- ❖ Dist Dest (distance in nm to destination)
- ❖ ETE Dest (estimated time enroute to destination)
- ❖ Ground Speed (in nm)
- ❖ GPS Alt (altitude in ft)
- ❖ Track (in °M)
- ❖ Accuracy (in m)

Timer Page

The timer page contains two up-counting timers. Tapping on a timer will start it, and tapping again will stop it. Force touch on the screen to bring up a menu with the options **Reset All**, **Reset Top**, **Reset Bottom**, and **Cancel**.

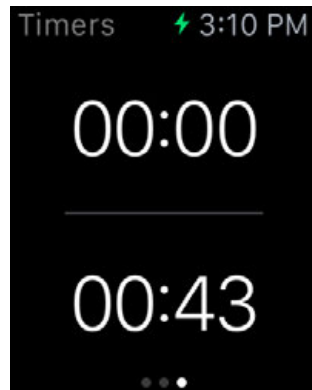

ADS-B Weather

Overview

ForeFlight Mobile can display ADS-B FIS-B weather data from a number of supported portable and installed ADS-B receivers. See <https://foreflight.com/connect/> for full details about the currently supported receivers. Please consult your specific device's documentation to learn about how to set up and connect the device.

ADS-B Weather Products

These are the weather products available from ADS-B:

- ❖ Radar - local and CONUS, shown on Maps. See radar color vs. intensity legends for [Rain](#).
- ❖ METARs and METAR-derived data shown on Maps, such as temperature
- ❖ TAFs
- ❖ Winds Aloft
- ❖ TFRs on Maps page **SEE IMPORTANT NOTICE BELOW**
- ❖ PIREPs on Maps page
- ❖ AIRMETs/SIGMETs on Maps page
- ❖ Special Use Airspace status - shown on Maps page when viewing airspace details. Hold finger on airspace to view pop-over. Make sure **All** is selected at bottom of pop-over to see airspace details.
- ❖ Outage messages - messages about outages in ADS-B system can be viewed in Stratus status view.

The items listed above are viewed just as they are when on the ground using an Internet connection. There is no user-configuration required beyond ensuring the iPad or iPhone is connected to the ADS-B receiver's Wi-Fi or Bluetooth connection.

TFRs IMPORTANT NOTICE:

While using an ADS-B receiver, up-to-date graphical TFR information is ONLY displayed if you select the TFR Map layer.

However if the FAA publishes a TFR without associated graphical shape information it may not be possible for ForeFlight Mobile to show the graphical TFR on the Maps page.

You should ALWAYS check the Airports page, under NOTAMS > TFRs for airports along your route, and contact FSS or ATC to confirm that your route does not cross any such TFRs.

TFR data may not be updated or displayed if you are using an ADS-B receiver that does not “replay” data received while the iPad is “asleep” or is not connected. Stratus Replay in the Stratus 2/2S saves 30 minutes of recent TFR data for display when ForeFlight Mobile is reopened. TFR data may also not be updated or displayed if the ADS-B receiver is not receiving data from ADS-B towers, or if the ADS-B towers are not broadcasting information about that TFR.

Status Information

When an ADS-B receiver is connected and a Map layer is selected, the number of Towers being received is shown in the upper-left corner of the Map, underneath the timestamp. The name of the receiver (if known) is shown to the left of the number of towers. When 0 towers are being received, **0 Towers** is shown in Red. When 1 tower is being received, **1 Tower** is shown in Orange, and when more than 1 tower is being received the text is shown in white:

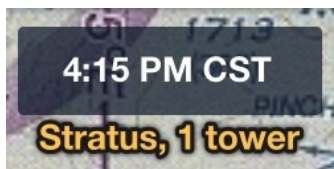
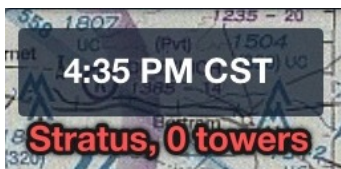

Animated ADS-B Radar

When the Radar layer is selected on the Maps page, the animation play button is displayed in the lower-left corner of the screen. ForeFlight Mobile will animate (loop) up to 5 frames of NEXRAD data. Regional NEXRAD (within ~250 nm of your position) is updated every 5 minutes, while CONUS radar is updated every 15 minutes.

If you tap the play button before 2 or more frames of radar data have been received, you will see a message that the radar cannot be animated until more data is received.



Tap the Maps Settings (gear) button and then select the ADS-B receiver > Status to see how many radar frames have been received.

Settings	Stratus Status
DEVICE	
Connected	Yes
Battery	99%
Power Source	Battery
Serial Number	
Firmware	1.4.0.396
Driver Version	2.6.B6
DATA	
Local Radar Update	None
National Radar Update	None
Radar Frames	0
Text Update	None
Text Report Count	0
Receiving From	1 Tower >
STRATUS REPLAY	
Status	Up-to-date
TRAFFIC	

ADS-B Tower Location on Map

When **Show ADSB Towers** is **ON** in the ADS-B receiver > Status settings, the location of each ADS-B Tower currently being received is shown on the Map.

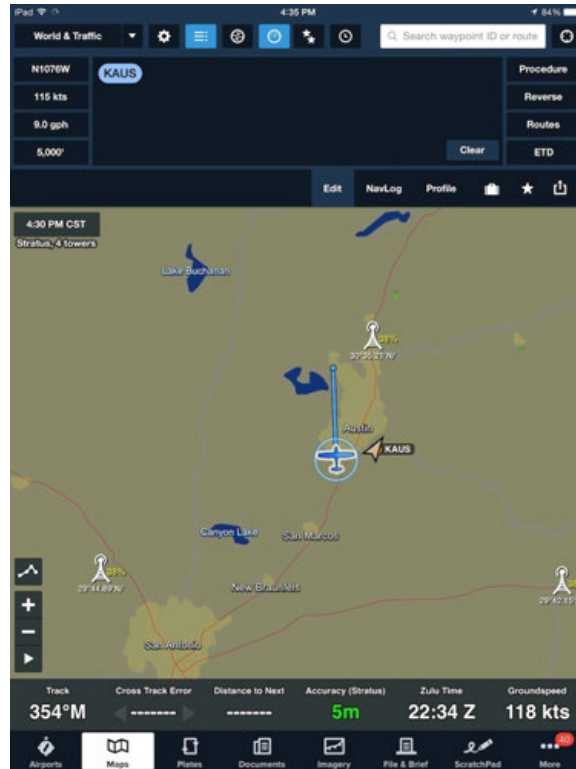

The Lat/Long location of each tower is shown under the tower icon, and the signal quality (0-100%) is shown to the right of the tower icon. If quality decreases, the signal quality is shown in yellow or red, and fewer graphical signal quality indicators are shown above the antenna:



As long as you are receiving data from 1 tower you should be receiving timely weather data and radar updates.

ADS-B Traffic

Overview

ForeFlight Mobile can display ADS-B TIS-B traffic from a number of supported portable and installed ADS-B receivers. See <https://foreflight.com/connect/> for full details about the currently supported receivers. Please consult your specific device's documentation to learn about how to set up and connect the device.

IMPORTANT TRAFFIC NOTICE

TRAFFIC DISPLAY FEATURES MAY NOT SHOW ALL AIRCRAFT IN THE AREA AND ARE NOT TO BE USED AS A PRIMARY MEANS OF AIRCRAFT VISIBILITY, DETECTION OR AVOIDANCE. TRAFFIC DISPLAYED WILL VARY DEPENDING ON ADS-B COVERAGE AREAS AND ON THE TYPE AND VERSION OF ADS-B "IN" AND ADS-B "OUT" EQUIPMENT INSTALLED IN YOUR AIRCRAFT AND OTHER AIRCRAFT.

IF YOUR AIRCRAFT IS NOT EQUIPPED WITH ADS-B "OUT", YOU WILL NOT RECEIVE A COMPLETE PICTURE OF TRAFFIC. YOU MAY EVEN RECEIVE NO TRAFFIC AT ALL. THIS IS DUE TO THE DESIGN AND IMPLEMENTATION OF THE ADS-B/TIS-B SYSTEM BY THE FAA.

Traffic Access in ForeFlight Mobile

Some ADS-B receivers like the Stratus 1/1S include a single-band 978 MHz UAT receiver, while dual-band receivers like the Stratus 2/2S include a dual-band 978 MHz UAT + 1090 MHz receiver. ADS-B traffic may be transmitted over one or both bands. Aircraft operating above 18,000' use the 1090ES band, though these aircraft continue to broadcast on 1090ES when descending below 18,000'.

To display Traffic, tap the Maps drop-down and select the Traffic layer. Use the "Filter Traffic Settings" (later in this section) to hide traffic beyond 15nm or +/- 3,500' from your location.

Important Note:

ADS-B traffic data is NOT saved by Stratus Replay. When using any Stratus device, ForeFlight Mobile must be running in order for ADS-B traffic to be displayed.

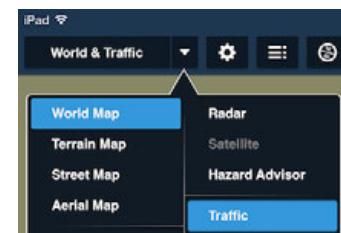





Status Information

To learn the status of the ADS-B receiver connection, data availability and more, use the Devices view as described above. When connected, the ADS-B receiver will be an option shown in the Devices view. Tap it to see full status information including the traffic updates received from ADS-B ground stations and aircraft on 978/UAT and 1090 bands.

Traffic Symbols

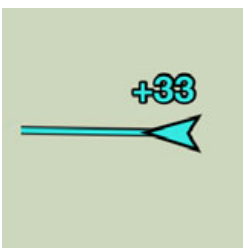
Moving traffic targets are displayed as “arrowheads” pointing in the direction that the target is traveling. Stationary targets, or ones with no direction or speed information, are shown as diamonds. Airborne traffic targets are shown in blue while surface targets are shown in brown. When a traffic target is within 5 NM horizontally and +/- 1,200’ vertically of your current position, the target’s color changes to yellow.

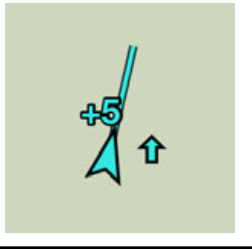
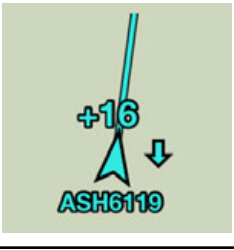
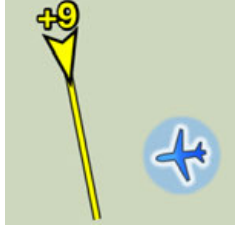
The relative altitude (in 100’s of feet) between your current altitude and the target’s altitude is shown with a + indicating above and a - indicating below your current altitude.

Moving target (+33 is 3,300’ above)		Stationary target, or unknown direction/speed (-30 is 3,000’ below)	
Climbing >500 ft/min (+5 is 500’ above)		Descending >500 ft/min (+16 is 1,600’ above)	
Within 5NM and +/- 1,200 (+9 is 900’ above)		Ground target (brown)	

The TrafficTrend™ vector is projected out of the front of the arrowhead to indicate the target’s expected position in the next 60 seconds (longer vector = faster speed).

IMPORTANT: Because of the way the ADS-B system (including aircraft ADS-B transmitters & receivers, and ADS-B ground stations) operates, ForeFlight Mobile may at times show relative altitudes of traffic targets based on the pressure altitude detected from your aircraft's ADS-B transmitter, and the pressure altitude read from a traffic target's ADS-B data. As a result of the cumulative inaccuracies in pressure altitude systems, you should consider any target shown to be within 500' vertically as potentially being at the same altitude as your aircraft. Never use ADS-B traffic data from ForeFlight Mobile as the sole means of traffic avoidance; always use "See & Avoid" or direct instructions from ATC.

NOTE: Some transmitted traffic data can be incomplete at times, so aircraft flight/tail number, vertical speed and TrafficTrend vector may not be available for one or more targets.

Aircraft equipped with ADS-B "Out" transmit additional data such as their tail or flight number, which is shown below the target symbol.

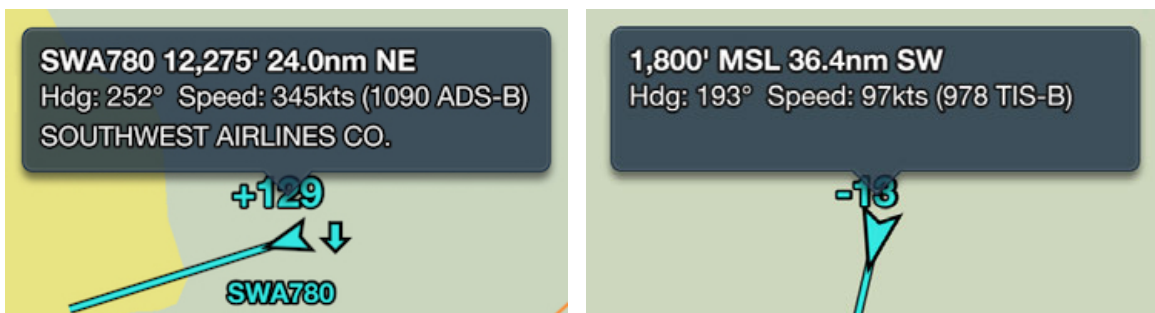

You can tap on any target to display a pop-up with additional information, which can include target tail or flight number, heading, speed, relative direction and altitude vs, your current position, and whether the information was broadcast via 978 or 1090. If the traffic target has a three-letter callsign, the pop-up will also show the phonetic name for that callsign as well as the company name it refers to. Tap anywhere to close the pop-up.

Hide Distant Traffic Setting

The Hide Distant Traffic setting, shown when your iPad or iPhone is connected to an ADS-B receiver, is accessed via the “Gear” button on the Maps page or on the More page under Devices > ADS-B receiver > Status.

When switched ON, this setting hides traffic that is more than 15NM away from your current GPS location and/or more than 3,500’ above or below your current altitude. This allows you to hide distant traffic targets and may be useful if you are flying in busy airspace or near large airports with lots of commercial traffic.

Ownship ADS-B Out Information

If your aircraft is equipped with ADS-B Out that is correctly configured and transmitting, tap the **Ownship ADS-B Out** entry in ADS-B Receiver Status to see the tail-number, altitude and location being broadcast by your ADS-B Out equipment.

If your aircraft is not equipped with ADS-B Out, or the ADS-B Out is improperly configured or is not transmitting, the **Ownship ADS-B Out** entry shows **Not Detected**.

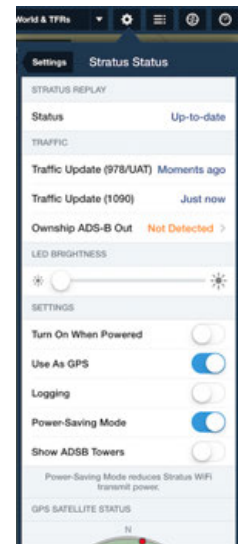
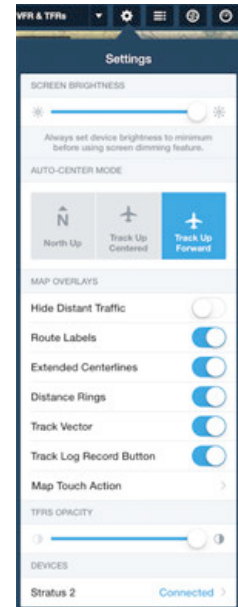

Traffic Alerts

When the **Traffic Alerts** setting is *ON* in **More > Settings > Alerts**, a traffic pop-up will be displayed if your aircraft is moving at over 40kts and an ADS-B traffic target comes within 1.8 NM horizontally and +/- 1,200' vertically of your aircraft's position.

The pop-up includes "clock" direction (relative to your aircraft's current track) and relative altitude information to help you locate the target more quickly.

If ForeFlight detects that your aircraft is equipped with ADS-B Out, an audio alert will also be issued with the same information as the visual pop-up. If no ADS-B Out is detected, **you will not receive traffic audio alerts**, but you will still receive the visual pop-up.

If your aircraft is not equipped with ADS-B Out but you fly within range of the traffic "puck" around another aircraft that is equipped with ADS-B Out, you may see a false target representing your aircraft, and a visual traffic alert may also be displayed.

NOTE: Traffic alerts are **ADVISORY** in nature and are **NOT** a replacement for "See & Avoid" or ATC traffic advisories.

IMPORTANT: Because of the way the ADS-B system (including aircraft ADS-B transmitters & receivers, and ADS-B ground stations) operates, ForeFlight Mobile may at times show relative altitudes of traffic targets based on the pressure altitude detected from your aircraft's ADS-B transmitter, and the pressure altitude read from a traffic target's ADS-B data. As a result of the cumulative inaccuracies in pressure altitude systems, you should consider any target shown to be within 500' vertically as potentially being at the same altitude as your aircraft. Never use ADS-B traffic data from ForeFlight Mobile as the sole means of traffic avoidance; always use "See & Avoid" or direct instructions from ATC.

Like the Runway Proximity Advisor™, the Traffic Alert pop-up will display on any screen in ForeFlight Mobile. However if ForeFlight Mobile is not displayed on the screen (e.g., if you are viewing another app, or the iPad or iPhone is sleeping) Traffic Alert pop-ups will not be shown.

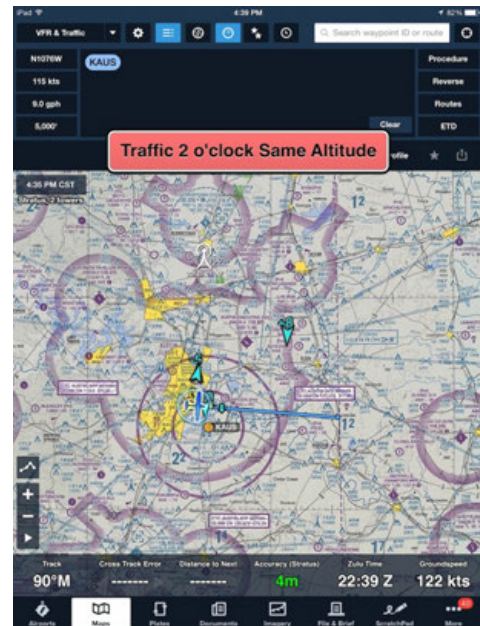

ForeFlight Connect

Overview

ForeFlight Connect allows ForeFlight Mobile to wirelessly connect to and exchange information with portable devices as well as panel-mount avionics to make flying easier, safer and more efficient.

Scout

Scout is a dual-band ADS-B receiver developed by ForeFlight and uAvionix that enables the display of inflight weather and traffic in ForeFlight. For instructions on how to power Scout, download the Scout Quickstart Guide from the Documents view Catalog, in the ForeFlight section. Purchase Scout on Amazon [here](#).

Note: Scout does not include a GPS and will not provide position information in ForeFlight. If using Scout with a device that does not include an internal GPS you will need to use an external GPS receiver to see your position in ForeFlight.

Connecting to Scout

After powering on Scout, open **Apple Settings** > **Wi-Fi** and select “Scout-XXXX” (where “XXXX” is a series of numbers and letters) to connect to Scout’s Wi-Fi network. If connecting to an early production Scout for the first time the Wi-Fi name will be “Ping-XXXX”; a firmware update will be immediately available in ForeFlight to update the Wi-Fi name to “Scout-XXXX”.

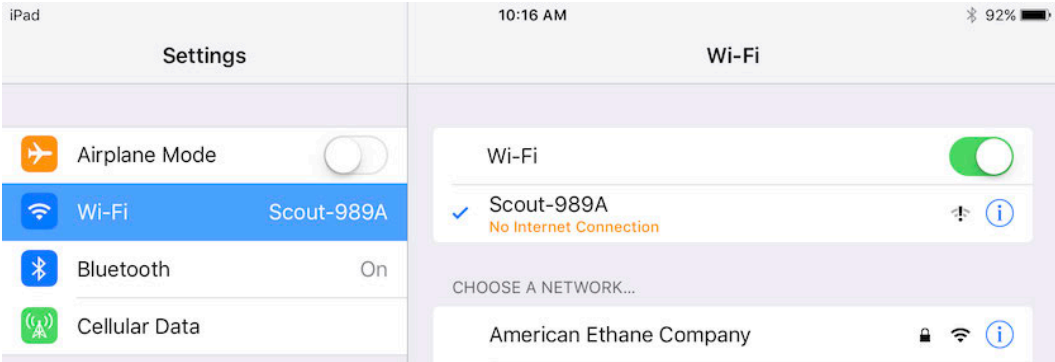

Using Scout

After connecting to Scout, open ForeFlight Mobile and tap on More > Devices. You should see a box for Scout indicating that the connection is established and listing the data being received from Scout.

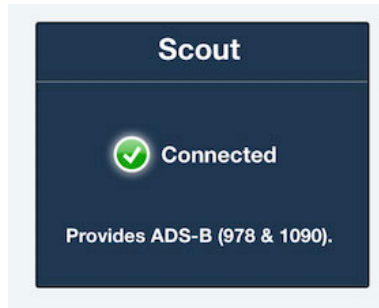

Tapping this box will open Scout's status page, providing detailed information about the device and the data being received from it.

There are two settings that can be adjusted at the bottom of Scout's status page:

- ❖ Logging - used only for diagnosing problems, this manages logging of ADS-B data stream received by Scout. You should leave this OFF normally, as it reduces app performance.
- ❖ Show ADS-B Towers - show the location on the Map of the ADS-B Towers currently being received.

A screenshot of the Scout status page in the ForeFlight Mobile app. The page is titled "Scout" and has a "Devices" tab selected. It is divided into several sections: "DEVICE STATUS", "DATA", "TRAFFIC", and "SETTINGS".

DEVICE STATUS	
Firmware	2.2.9
Wifi Version	1.3.0
Serial Number	329161381
Connection	Connected

DATA	
Local Radar Update	None
National Radar Update	None
Radar Frames	0
Text Update	None
Text Report Count	0
Receiving From	0 Towers >

TRAFFIC	
Traffic Update (978/UAT)	None
Traffic Update (1090)	Now
Traffic Update (TIS-B)	None
Ownship	Not Detected >

SETTINGS	
Logging	<input type="checkbox"/>
Show ADSB Towers	<input type="checkbox"/>

ADS-B From Scout

When an ADS-B layer such as Radar or Traffic is selected on the Maps view, the number of ADS-B towers being received by Scout is shown in the upper-left corner of the view below the timestamp indicating when the last update was received.

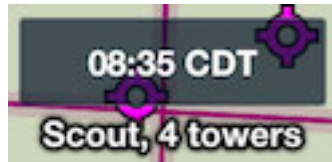

Updating Scout's Firmware

Firmware updates for Scout are included in new versions of ForeFlight, allowing you to easily update the device directly within ForeFlight.

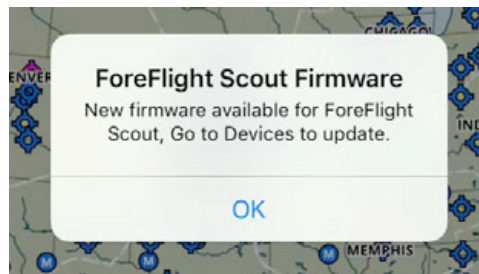

If a new firmware update is available, a message will appear when you connect to Scout and open ForeFlight. Go to More > Devices and tap on the Scout badge, then tap "Tap to Update" to begin the update process.

Stratus ADS-B Receivers

ForeFlight Mobile supports the Stratus family of ADS-B receivers, which are manufactured in the USA by Appareo. These devices provide ForeFlight Mobile with the ability to access ADS-B FIS-B (weather) and TIS-B (traffic) data from the network of ADS-B ground stations. Please consult the Stratus documentation to learn about how to set up and connect the device.

Multiple iPads or iPhones running ForeFlight Mobile can simultaneously connect to a Stratus using Wi-Fi. There is no significant practical limit to the number of iOS devices that can be connected to Stratus at once.

It is recommended that cellular data be turned OFF when using a Stratus ADS-B receiver.

Stratus Status Information

To see more detailed Stratus status information, tap the Map Settings “gear” button and then tap the Stratus entry, or tap on **More > Devices > Stratus > Status**.

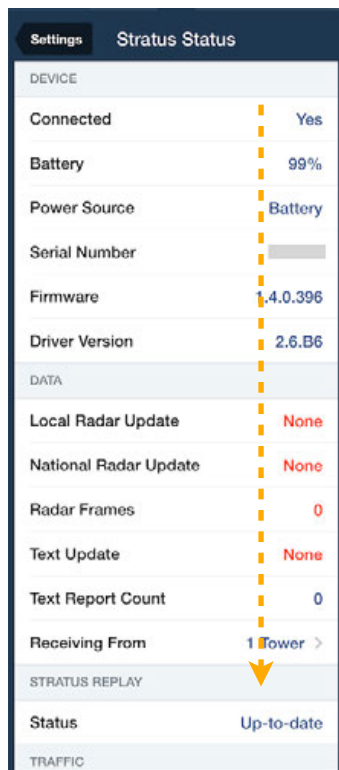

Scroll down to see additional settings and GPS Satellite Status

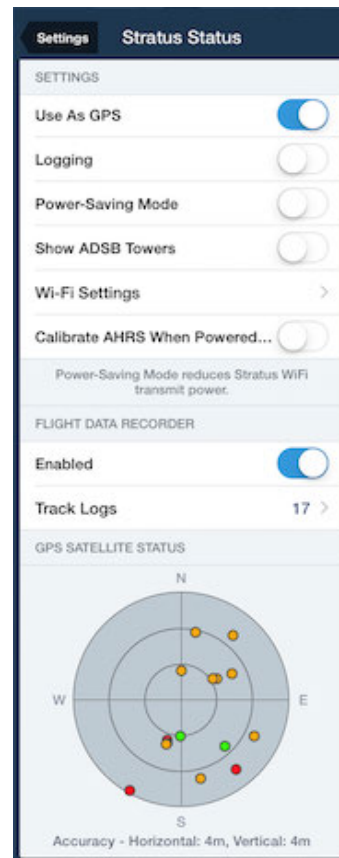

The following details and Settings are provided on the Status view:

- ❖ Connected - shows “Yes” if a Stratus is connected via Wi-Fi.
- ❖ Battery - indicates remaining battery life in percent remaining. Not shown when charging Stratus.
- ❖ Power Source - indicates whether Stratus is being charged.
- ❖ Serial Number - Stratus serial number, only needed for technical support concerns.
- ❖ Firmware version - current version of firmware installed on Stratus.
- ❖ General NOTAMs - list of NOTAMs provided by ADS-B that were not assigned to an airport in ForeFlight Mobile.
- ❖ Local/National Update - date of most recent radar data, local data is generally < 5m old, national is generally < 15m old.
- ❖ Text Update - last time a new text report was downloaded (ex. METAR, TAF, Winds Aloft).
- ❖ Text Report Count - number of ADS-B-provided text reports in ForeFlight Mobile.
- ❖ Receiving From - number of ground-based towers currently providing Stratus with data. Number of towers is also shown on the Map below the timestamp.
- ❖ Stratus Replay Status (Stratus 1S/2S/2 Only) - indicates if the ADS-B data saved by Stratus, while ForeFlight Mobile was in the background or the iPad was sleeping, has been sent to ForeFlight Mobile. Up to 30 minutes of data is saved.
- ❖ Traffic Update (978/UAT) and (1090) - when traffic data was received on either band (1090 requires Stratus 2/2S).
- ❖ Ownship ADS-B Out - if your aircraft is equipped with ADS-B Out, tap this entry to display the information detected by the Stratus about your ADS-B Out transmissions.
- ❖ LED Brightness - used to adjust brightness of LEDs on Stratus.
- ❖ Turn On When Plugged In - when ON the Stratus will turn on when power is provided over the USB cable and turn OFF when power is removed. When power is removed the Stratus will turn OFF in 2 minutes only if the speed is < 5 knots. If speed is > 5 knots, the Stratus will not turn off until the speed drops below 5 knots, or the power button is pressed.
- ❖ Use As GPS - when ON, the Maps and other views will use GPS fix info from Stratus.

- ❖ Logging - used only for diagnosing problems, this manages logging of ADS-B data stream received by Stratus. Leave this OFF normally, as it reduces app performance.
- ❖ Power-Saving mode - reduces the WiFi transmit power to increase battery life.
- ❖ Show ADS-B Towers - show the location on the Map of the ADS-B Towers currently being received.
- ❖ WiFi Settings - implements WiFi security for the Stratus local network. Disabling SSID Broadcast makes your network's name invisible to other iPads/iPhones, preventing them from joining your Stratus network unless they know the name of the network. Enabling WPA2 Security allows you to add a passcode to your device's WiFi which must be entered in the WPA2 Passcode box when joining the network. Changes to the Stratus WiFi Settings require that the device be restarted. **Note:** If you forget the Network name or WPA2 passcode you set for your device, perform a factory reset to return it to default conditions: SSID Broadcast - Enabled, WPA Security - OFF, and no passcode. You can perform a factory reset by holding the Stratus power button for 30 seconds
- ❖ Ignore Mfg. AHRS Settings (Stratus 2 and 2S) - when *ON*, Stratus will automatically recalibrate its AHRS every time it is powered on. **It is recommended that this setting remain OFF** unless the Stratus is providing subpar AHRS readings, which can happen after the Stratus is dropped or subjected to very large temperature variations. If you are receiving subpar AHRS readings, turn this setting *ON* and power cycle the Stratus while keeping the device as stationary as possible. The setting should then be turned back to *OFF*.
- ❖ Save AHRS Calibration (Stratus 2 and 2S) - when *ON*, Stratus will save a manual AHRS calibration between power cycles so it does not automatically re-adjust to straight and level every time it is turned back on. This setting is useful for pilots who cannot calibrate the Stratus on the ground due to their aircraft (or Stratus device) not being straight and level, such as with tail dragger aircraft. **Note:** The use of this feature depends on the Stratus not being moved after it is calibrated; moving the Stratus between flights will cause the saved calibration to become inaccurate, requiring a re-calibration during the next flight.
- ❖ Flight Data Recorder (Stratus 2/2S only) - when "Enabled " is *ON*, Stratus will begin recording a track log as soon as it is turned on and the GPS senses motion (see [Stratus Flight Data Recorder](#) for more information)
- ❖ Track Logs (Stratus 2/2S only) - tap to view any track logs recorded by Stratus.

- ❖ Auto-Detect Segments (Stratus 2S only) - when *ON*, Stratus will automatically detect trip segments based on your ground speed and create a separate track log for each segment.
- ❖ GPS Satellite Status - shows location and signal lock for GPS satellites currently visible.

Stratus ESG (Stratus 1S/2/2S Only)

Stratus ESG is Appareo’s all-in-one certified ADS-B Out transponder solution. The Stratus 1S, 2, or 2S can connect to Stratus ESG via USB cable (included in the Stratus ESG installation kit provided by the avionics dealer) to take advantage of the Stratus ESG’s certified WAAS GPS receiver and aircraft-mounted ADS-B antenna to boost GPS accuracy and provide improved ADS-B In tower reception. When connected via the USB cable, the Stratus ESG also supplies power to the Stratus 1S, 2, or 2S to keep the battery charged.

When a Stratus 1S, 2, or 2S is connected to the Stratus ESG, the Accuracy instrument in ForeFlight’s [Instrument Panel](#) will show “Accuracy (ESG)” to indicate that it is receiving GPS position data from the ESG.

Stratus Replay (Stratus 1S/2/2S Only)

Stratus Replay saves the last 30 minutes of ASD-B weather information received by the device, including NEXRAD Radar, METARs, TAFs, etc. Stratus Replay automatically sends saved data to ForeFlight when you reopen the app after sleeping the iPad or iPhone, or switching from another app. This allows you to conserve battery life by opening ForeFlight only when needed without fear of missing useful ADS-B weather information.

Stratus Replay requires that the device be updated to Firmware v1.4 or later for a Stratus 2 and v1.0 or later for a 1S/2S. See [Stratus Firmware Update](#) for instructions on updating the Stratus firmware. **NOTE:** Stratus Replay is not available with the Stratus 1.

You can check the Stratus Replay status by tapping the Map Settings “gear” button and then choosing Stratus, or on **More > Devices > Stratus > Status**.

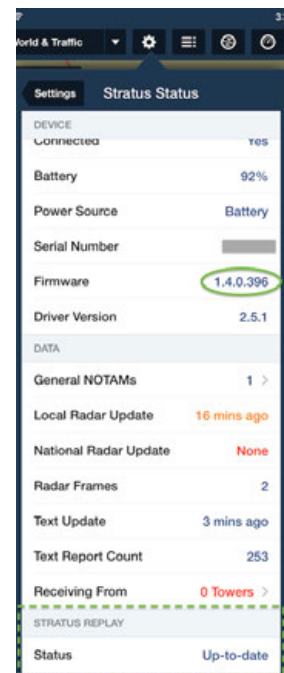

Stratus Flight Data Recorder

The Flight Data Recorder feature allows a Stratus 2/2S to save a Track Log file of your flights. The Track Log file includes your position, speed and altitude data throughout each of your flights, and it can be saved regardless of whether you record a [Track Log](#) in ForeFlight Mobile.

When activated, the Flight Data Recorder will save up to approximately 20 hours of data, and will automatically delete the oldest track log file from the device to make room to record the new track log file. The Flight Data Recorder becomes available with Firmware v1.6 for a Stratus 2 and v1.0 for a Stratus 2S.

Recording a Track Log Using the Flight Data Recorder

Turn on the Flight Data Recorder on the Maps page by tapping the **Maps Settings** (gear button) then tapping **Stratus Status**. Alternatively you can tap **More > Devices > Stratus > Status** and slide the “Enabled” switch to ON.

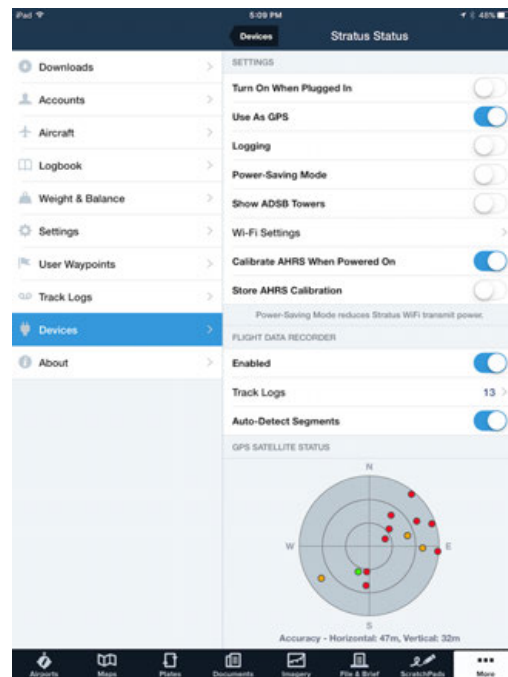
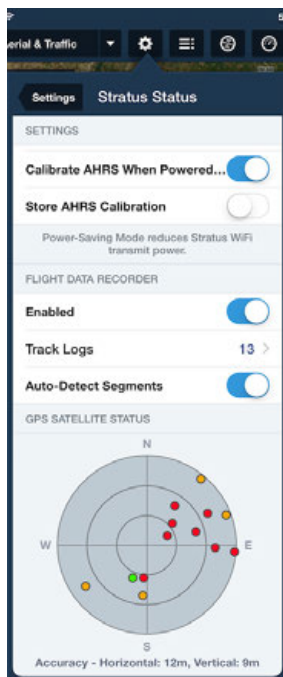

Track log files will begin recording automatically as soon as the Stratus 2/2S is turned on and the GPS senses motion.

The Track Log file will record until the device is turned off, unless “Auto-Detect Segments” is turned ON, in which case a Track Log will stop recording when Stratus

detects a full-stop landing, and another Track Log will be started. Once the device is turned back on, the most recent Track Log file or files will be shown in the “Track Logs” section, accessed by tapping below the Enabled switch.

Tap “Track Logs” to see any track logs recorded by the Stratus 2/2S. To save a Track Log to ForeFlight Mobile, tap the “Cloud” icon next to the Track Log.

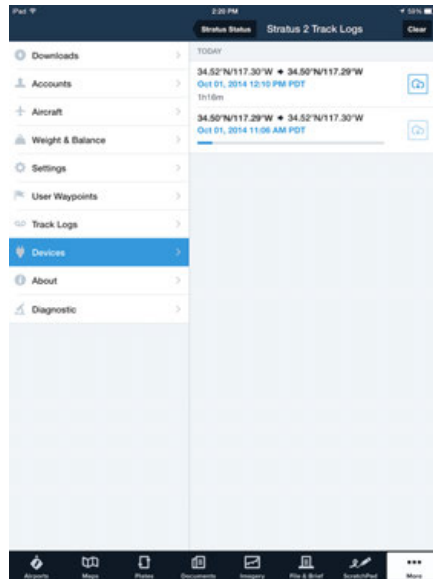

Once that Track Log has been saved to ForeFlight Mobile, you can transfer it to your ForeFlight account where it can be viewed and shared like other Track Logs. Disconnect your iPad from the Stratus 2/2S WiFi network, connect to the Internet, then tap **More > Track Logs** and tap the “Cloud” icon next to that Track log. See [Viewing Track Logs on your ForeFlight Account](#) for more details.

When connected to a Stratus 2/2S, Track Logs can also be accessed directly from the **More > Track Logs** page by tapping the **Stratus Logs** button.

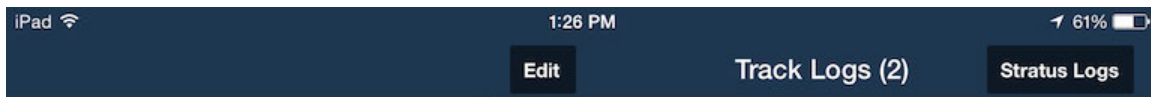

Stratus Firmware Update

Appareo, the manufacturer of the Stratus ADS-B receivers, periodically releases updated firmware to activate new capabilities or fix issues. This firmware can be installed by ForeFlight Mobile. For more information, please watch this video: <https://www.youtube.com/watch?v=r-5spKWk40Y>

Before beginning the update process, make sure that your iPad or iPhone AND the Stratus each have enough battery power to run for at least 15 minutes. If you are unsure, plug each device in to an appropriate charger.

Turn the Stratus ON, then open Apple Settings, tap WiFi and connect your iPad or iPhone to the Stratus WiFi network.

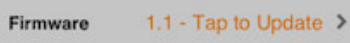
Open ForeFlight Mobile, then go to the Devices view and tap the Stratus button. Then tap the "Tap to Update" on the Firmware row:  to begin the update. Once the update is complete, tap the "Close" button to return to ForeFlight Mobile.

IMPORTANT: The Stratus will reboot during the firmware update process. When this happens, if there is a known WiFi network in range your iPad or iPhone will reconnect to the other WiFi network. This will cause an error message at the end of the update process since ForeFlight Mobile is no longer connected to the Stratus WiFi network and cannot verify the firmware update.

If this happens, simply quit ForeFlight Mobile, re-connect your iPad or iPhone to the Stratus WiFi network, re-open ForeFlight Mobile and go to the Devices, Stratus page. Verify that the new Stratus Firmware version is listed.

You can avoid this error message either by doing the update in an area with no other WiFi networks, or by, before starting the update, opening Apple Settings, tapping WiFi and "forgetting" any WiFi networks to which your iPad or iPhone may automatically connect.

Garmin Connex

The Garmin Connex system allows ForeFlight Mobile to receive GPS position data, ADS-B weather and ADS-B traffic from select Garmin avionics by connecting to a Garmin Flight Stream 110, 210, or 510 bluetooth gateway. The Flight Stream 210 also includes an AHRS sensor, providing pitch and bank information to the attitude display in ForeFlight Mobile, and supports two-way flight plan transfer between ForeFlight Mobile and select Garmin navigation displays. ForeFlight Mobile does not currently support receiving XM Weather or music through a Flight Stream.

Pairing with Flight Stream

Once a Garmin avionics dealer has correctly installed a Flight Stream 110, 210, or 510 and connected it to your Garmin avionics, open Apple Settings and tap the Bluetooth tab on the left. If your Flight Stream is already in Bluetooth pairing mode it will appear in the list of available Bluetooth devices and you can tap on the entry to connect. If it doesn't appear, follow the instructions provided with the Flight Stream to enable Bluetooth pairing mode, then tap the Flight Stream entry to pair it with your device.

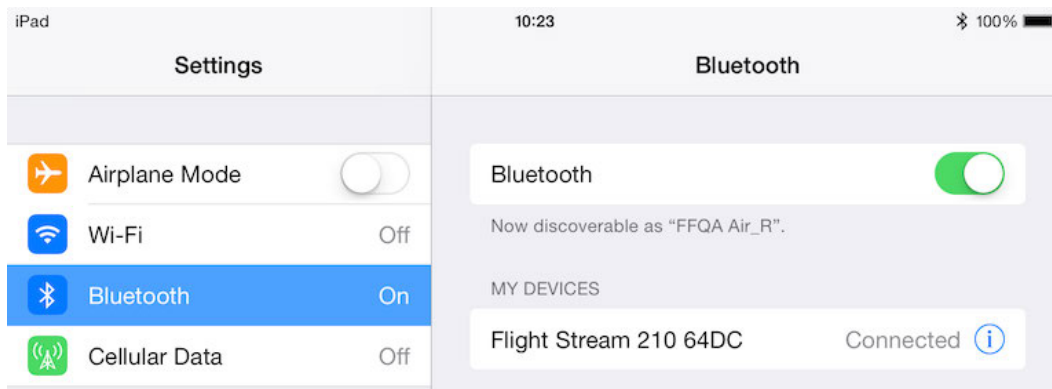

Using Connex

After pairing with the Flight Stream, open ForeFlight Mobile and tap on More > Devices. You should see a box for Garmin Connex indicating that the connection is established and listing the data being received through the Flight Stream.

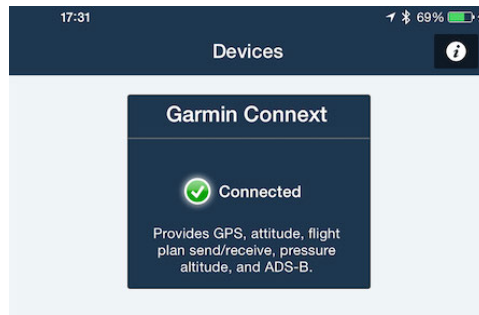

Tapping this box will open the device’s status page, providing detailed information about the device and the data being received from it. In addition to the Flight Stream, the status page will also show any Garmin avionics that are connected to the Flight Stream.

“Attitude from access point” indicates whether AHRS data is being provided by the Flight Stream 210 (the “access point” to the chain of Connex devices) or from another device in the chain.

If connected to a GNS or GTN unit with a route loaded, the details of that route will also be displayed. Tap on the route to load it into ForeFlight Mobile’s Route Editor.

IMPORTANT: DO NOT PRESS the “Reset AHRS” button at the bottom of the Settings page unless specifically directed to by the ForeFlight Pilot Support Team or your Garmin Avionics dealer.

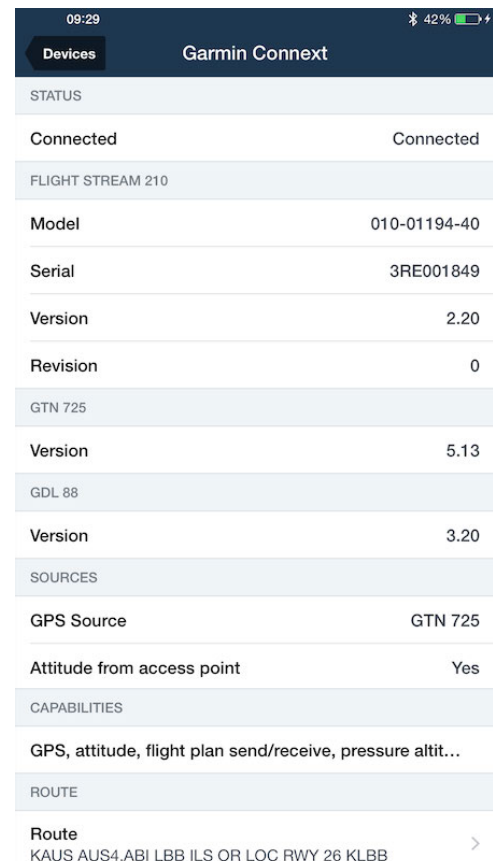

GPS and ADS-B from Connex

When GPS data is being sent from the Flight Stream to ForeFlight Mobile, the Accuracy instrument will show “Accuracy (Connex).”



When an ADS-B layer such as Radar or Traffic is selected on the Maps view, the number of ADS-B towers being received by the Flight Stream is shown in the upper-left corner of the view below the timestamp indicating when the last update was received.

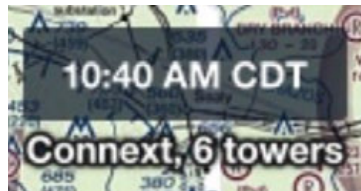

Sending a Route to Connex (requires Flight Stream 210 or 510)

On an iPad, tap the Panel button at the top of the Maps view and tap “Send to Panel”, or tap the Send To button in the bottom-right corner of the Flight Plan Editor and tap the Panel button to send a route to a GNS 430W/530W or GTN 600/700 series GPS navigator. NOTE: Flight Stream 510 only supports route transfer to GTN 600/700 series GPS navigators.

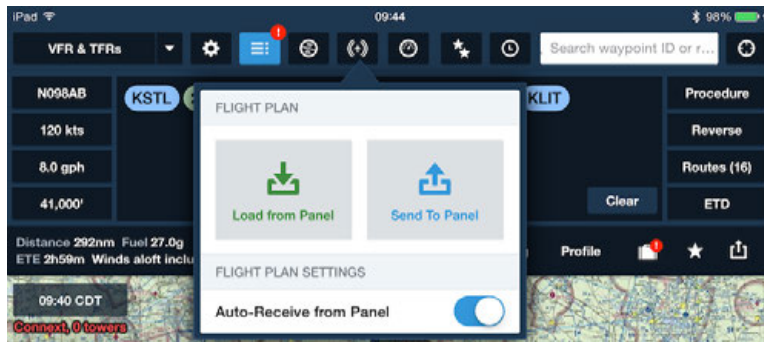

On an iPhone, tap Menu, scroll to the Route section and choose the Route. Then tap the “Send to” button in the bottom-right and tap “Panel.”

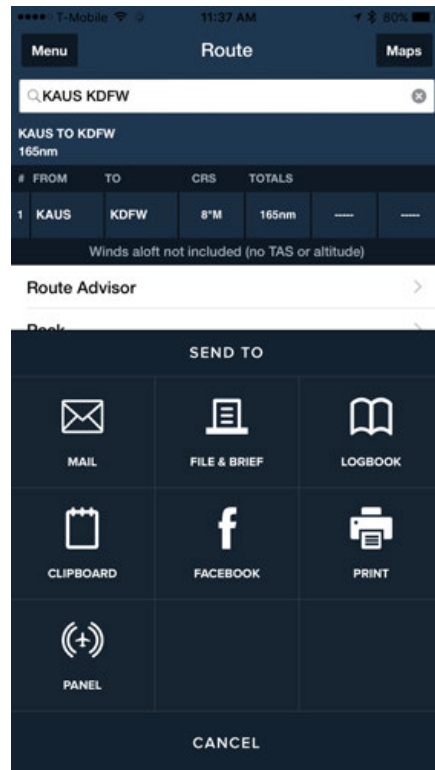
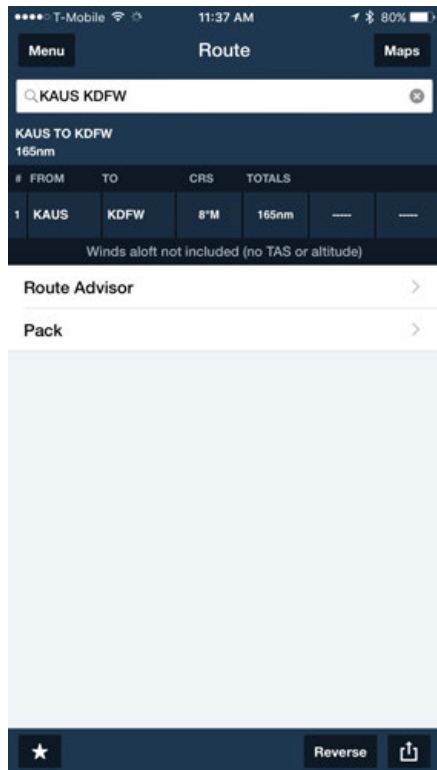

After sending the route a pop-up will open in ForeFlight confirming that the route has been successfully sent to the panel. Tap "OK" to dismiss the pop-up.

NOTE: Different Garmin GPS navigators support different numbers of waypoints per route. If you attempt to send a route with a too many waypoints for the installed Garmin GPS, the transfer will be rejected. A possible solution for this is to go to More > Settings > Route View and change the Airway Decoding setting to "Bends Only", which will remove any waypoints that do not result in a change in course. The route must be re-entered for this setting to be applied. After re-entering, you can re-send the route to the Garmin GPS via the Flight Stream 210 or 510.

Getting a Route from Connex (requires Flight Stream 210 or 510)

On an iPad, tap the "Panel" button at the top of the Maps view and tap "Load from Panel" to load a route from your Connex navigator to the ForeFlight Mobile Route Editor.

On an iPhone, go to Menu > Devices > Connex and scroll down to the Route section. Tap the route to load it into your Route Editor.

When "Auto-Receive from Panel" is enabled, changes to your route in the Connex device produce a notification in ForeFlight Mobile prompting you to load the modified route into your Route Editor, with options to Load Route or Ignore. When "Auto-Receive from Panel" is disabled, changes to your route in the Connex device do not produce a notification. This setting is also available in More > Settings > Map View as "Auto-Receive Panel Flight Plans."

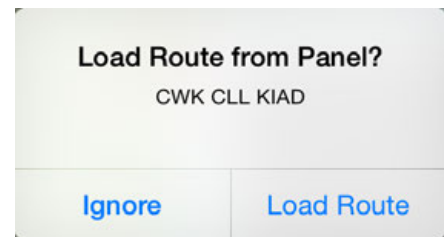

Calibrating Flight Stream 210 AHRS

The FlightStream 210 AHRS can be calibrated by tapping the AHRS Setting button in the attitude display, above the fullscreen button. This will activate Zero Pitch & Bank mode and a blue Save button will appear in the upper left corner of the display. Adjust your aircraft so that it is straight and level, tap the Zero Pitch & Bank button to zero the display, and tap the Save button to save the AHRS calibration.

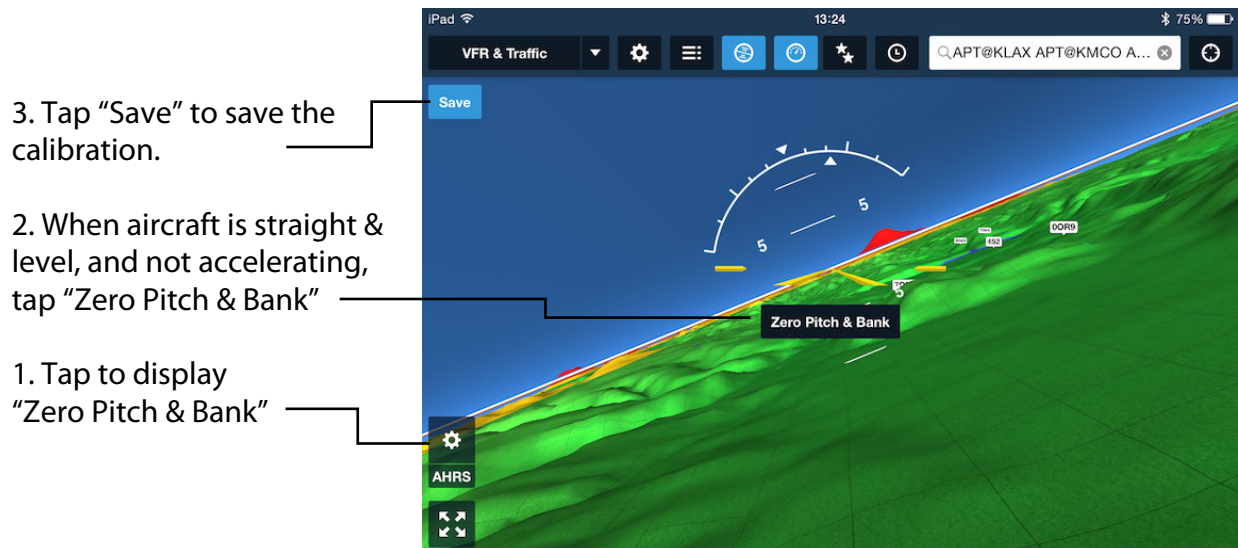

Note: AHRS calibration should only be performed while in level, unaccelerated flight, or while stationary and level on the ground. Calibrating the device while accelerating or decelerating may result in errors in pitch and bank information.

Garmin GTX 345

Garmin's GTX 345 ADS-B Out/In transponder can provide ForeFlight with WAAS GPS position data, ADS-B weather and traffic, pressure altitude, and AHRS information to drive ForeFlight's attitude indicator and Synthetic Vision. The GTX 345 appears in More > Devices as "Garmin Connex", although it can connect directly to ForeFlight via Bluetooth and does not require a separate Flight Stream.

Connecting to GTX 345

After your GTX 345 is installed in your aircraft by a certified Garmin avionics dealer, follow the instructions included with it to enable Bluetooth pairing mode. On your mobile device, open **Apple Settings > Bluetooth** and select the GTX 345 from the list of available devices. The GTX 345 can pair with up to two devices at once.

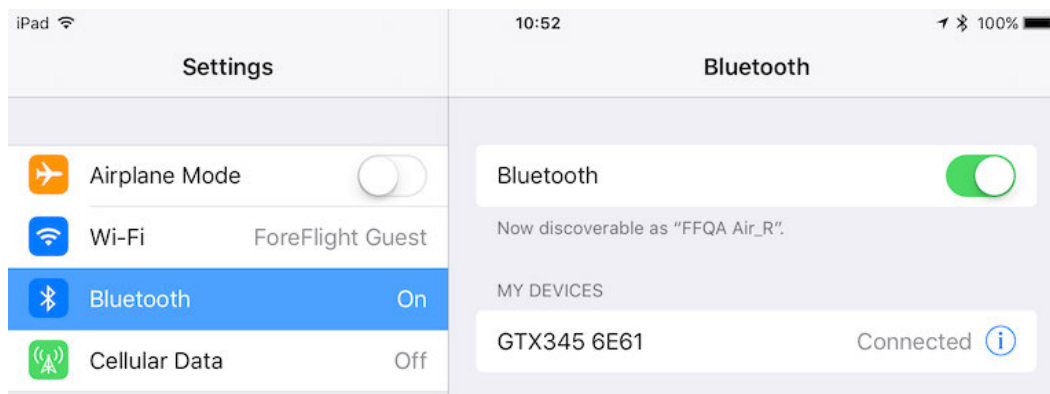

Using GTX 345

Once you've paired with the GTX 345 via Bluetooth, open ForeFlight and tap **More > Devices** to confirm the connection was recognized by ForeFlight and see what information is being received from the GTX 345. GPS is only shown here when a location fix has been established, so it may take a minute to appear immediately after the GTX 345 is powered on.

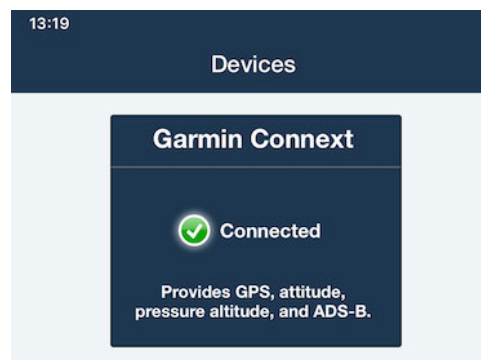

Tap the box to view the details of the GTX 345 and the data being received from it.

There are two settings that can be adjusted at the bottom of the GTX 345 status page:

- ❖ Logging - used only for diagnosing problems, this manages logging of ADS-B data stream received by GTX 345. Leave this OFF normally, as it reduces app performance.
- ❖ Show ADS-B Towers - show the location on the Map of the ADS-B Towers currently being received.

The GTX 345 ARHS pitch/roll values (used to drive the Synthetic Vision display) must be initially calibrated by your avionics shop at the time of installation.

GPS and ADS-B from GTX 345

When GPS data is being sent from the GTX 345 to ForeFlight, the Accuracy instrument will show "Accuracy (Connex)."

When an ADS-B layer such as Radar or Traffic is selected on the Maps view, the number of ADS-B towers being received by the GTX 345 is shown in the upper-left corner of the view below the timestamp indicating when the last update was received.

Garmin Connex	
STATUS	
Connected	Connected
GTX345	
Model	006-B1797-XX
Serial	3EG400057
Version	2.00.02
Revision	1
SOURCES	
GPS Source	GTX 345
Attitude from access point	Yes
CAPABILITIES	
GPS, attitude, pressure altitude, ADS-B	
DATA	
Local Radar Update	None
National Radar Update	None
Radar Frames	0
Text Update	None
Text Report Count	0
Receiving From	0 Towers >
TRAFFIC	
Traffic Update (978/UAT)	Just now
Traffic Update (1090)	None

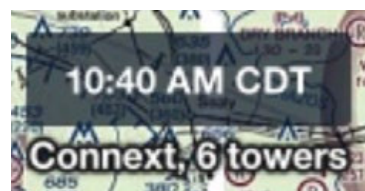

Calibrating the GTX 345 AHRS

The GTX 345 AHRS can be calibrated by tapping the AHRS Setting button in the attitude display, above the fullscreen button. This will activate Zero Pitch & Bank mode and a blue Save button will appear in the upper left corner of the display.

Adjust your aircraft so that it is straight and level, tap the Zero Pitch & Bank button to zero the display, and tap the Save button to save the AHRS calibration.

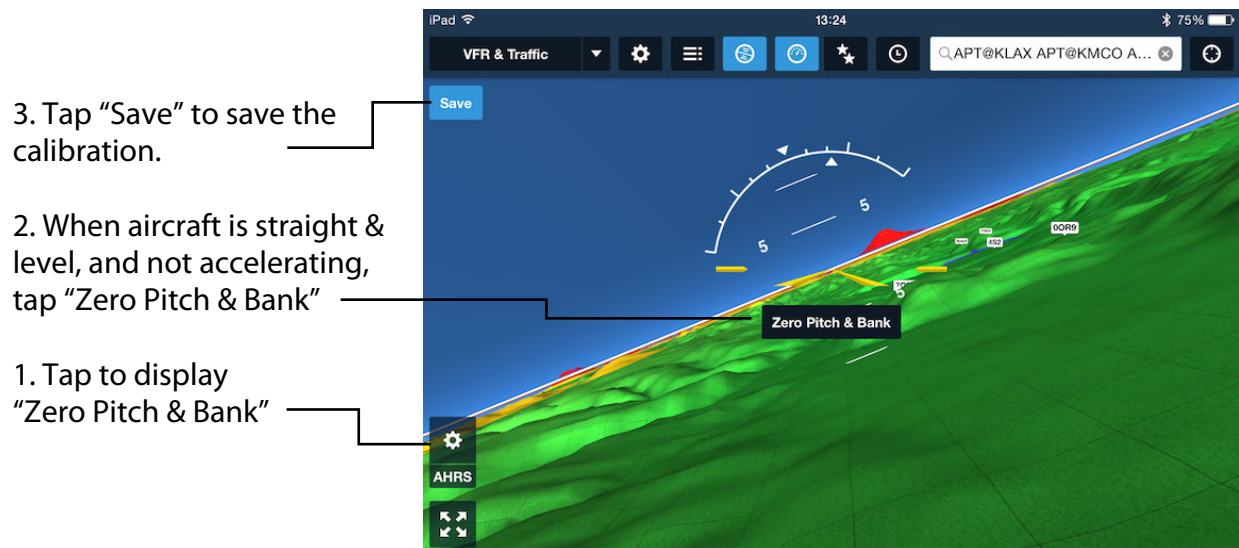

Note: AHRS calibration should only be performed while in level, unaccelerated flight, or while stationary and level on the ground. Calibrating the device while accelerating or decelerating may result in errors in pitch and bank information.

Garmin GDL 39

ForeFlight can connect to Garmin's GDL 39, GDL 39-3D, and GDL 39-R ADS-B receivers, which provide ADS-B weather and traffic, GPS position, pressure altitude, and AHRS information (GDL 39-3D) to power ForeFlight's attitude indicator and Synthetic Vision. The GDL 39 appears in More > Devices as "Garmin Connex", although it can connect directly to ForeFlight via Bluetooth and does not require a separate Flight Stream.

Connecting to GDL 39

After turning on the GDL 39, open **Apple Settings** > **Bluetooth** and tap "GDL39" to connect to the device.

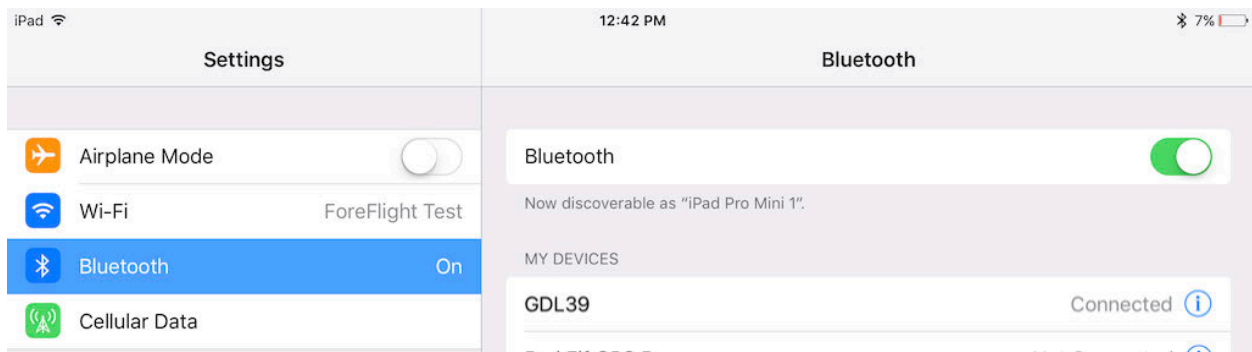

Using GDL 39

Once you've paired with the GDL 39 via Bluetooth, open ForeFlight and tap **More** > **Devices** to confirm the connection was recognized by ForeFlight and see what information is being received from the GDL 39.

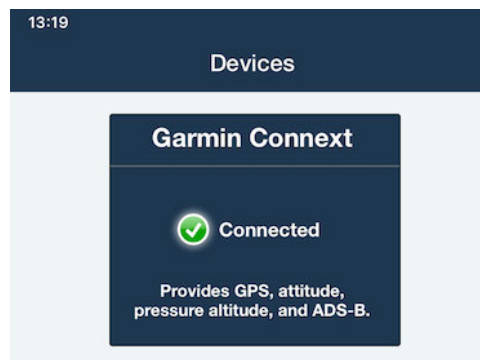

Tap the box to view the details of the GDL 39 and the data being received from it.

There are three settings that can be adjusted at the bottom of the GDL 39 status page:

- ❖ Logging - used only for diagnosing problems, this manages logging of ADS-B data stream received by GDL 39. Leave this OFF normally, as it reduces app performance.
- ❖ Show ADS-B Towers - show the location on the Map of the ADS-B Towers currently being received.
- ❖ Pressurized Cabin - enabling this will cause the GDL 39 to stop sending pressure altitude readings to ForeFlight, since those readings become inaccurate when the device is in a pressurized cabin.

IMPORTANT: DO NOT PRESS the “Reset AHRS” button at the bottom of the Settings page unless specifically directed to by the ForeFlight Pilot Support Team or your Garmin Avionics dealer.

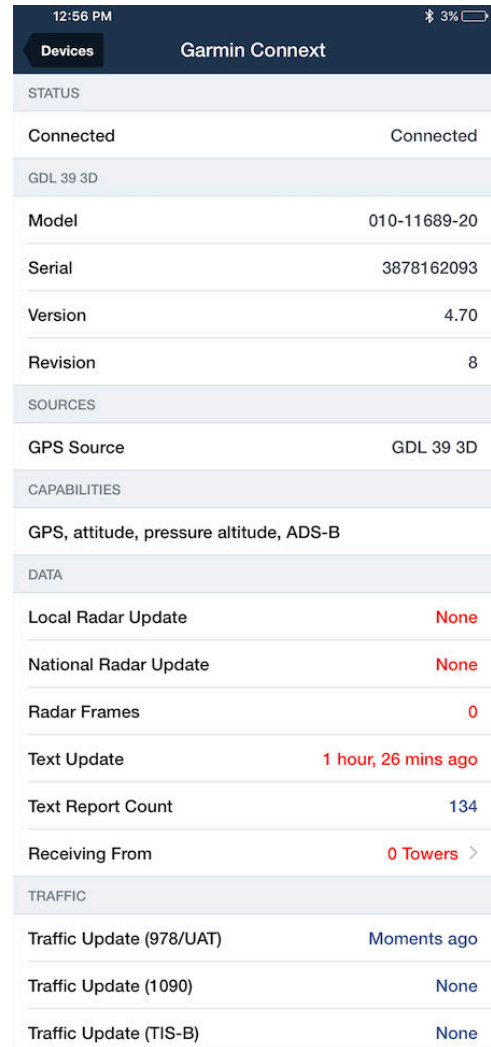
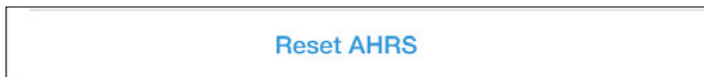
A screenshot of the Garmin Connex mobile application interface. The top status bar shows the time as 12:56 PM and battery level at 3%. The app title "Garmin Connex" is displayed. The interface is divided into several sections: STATUS (showing "Connected" for both the app and GDL 39 3D), SOURCES (showing "GPS Source" as "GDL 39 3D"), CAPABILITIES (listing "GPS, attitude, pressure altitude, ADS-B"), and DATA (showing radar update status: "Local Radar Update" and "National Radar Update" both as "None", "Radar Frames" as "0", "Text Update" as "1 hour, 26 mins ago", and "Text Report Count" as "134"). The TRAFFIC section shows "Receiving From" as "0 Towers" and "Traffic Update (978/UAT)" as "Moments ago", while "Traffic Update (1090)" and "Traffic Update (TIS-B)" are both "None".

GPS and ADS-B from GDL 39

When GPS data is being sent from the GDL 39 to ForeFlight, the Accuracy instrument will show “Accuracy (Connex).”

When an ADS-B layer such as Radar or Traffic is selected on the Maps view, the number of ADS-B towers being received by the GDL 39 is shown in the upper-left corner of the view below the timestamp indicating when the last update was received.

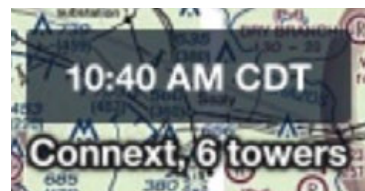

Calibrating GDL 39 3D AHRS

The GDL 39 3D AHRS can be calibrated by tapping the AHRS Setting button in the attitude display, above the fullscreen button. This will activate Zero Pitch & Bank mode and a blue Save button will appear in the upper left corner of the display. Adjust your aircraft so that it is straight and level, tap the Zero Pitch & Bank button to zero the display, and tap the Save button to save the AHRS calibration.

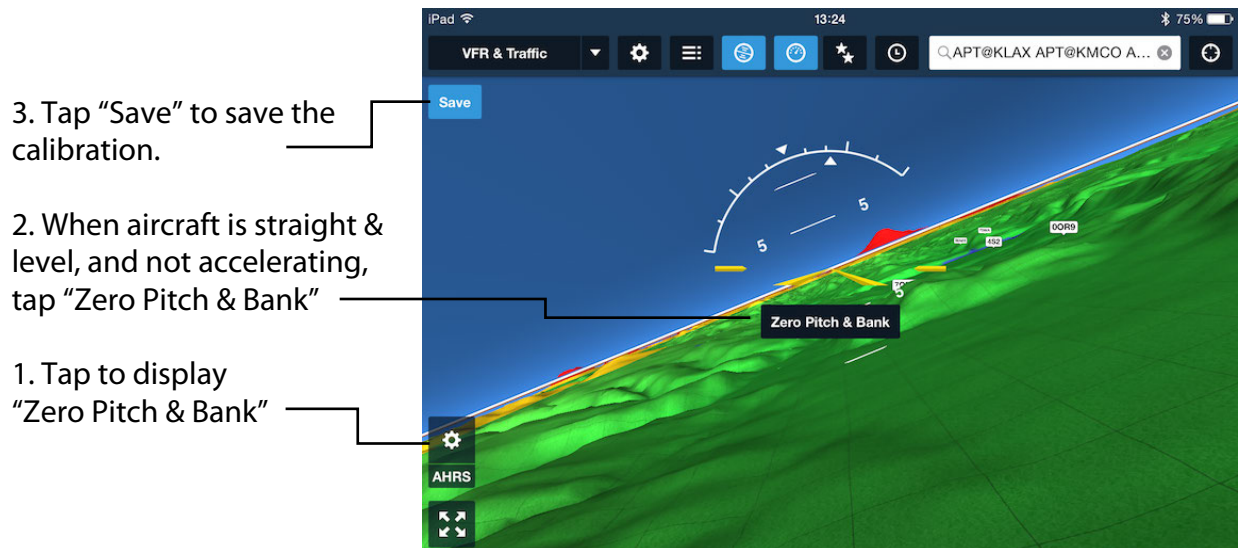

Note: AHRS calibration should only be performed while in level, unaccelerated flight, or while stationary and level on the ground. Calibrating the device while accelerating or decelerating may result in errors in pitch and bank information.

L-3 Lynx

ForeFlight can connect to L-3's Lynx line of ADS-B transceivers, including the NGT-9000, -2000, and -2500 models to receive ADS-B traffic and weather and GPS position via Wi-Fi in ForeFlight.

Connecting to Lynx

After the Lynx has been installed in your aircraft, open **Apple Settings** > **Wi-Fi** and select "LynxWiFi" to connect to the Lynx's Wi-Fi network. **NOTE:** In order to communicate with ForeFlight, the Lynx setting "Wi-Fi Dongle Application" needs to be set to "Other" (which corresponds to port 4000) via the setup software tools menu. Contact your L-3 avionics installer for information or to have this setting changed.

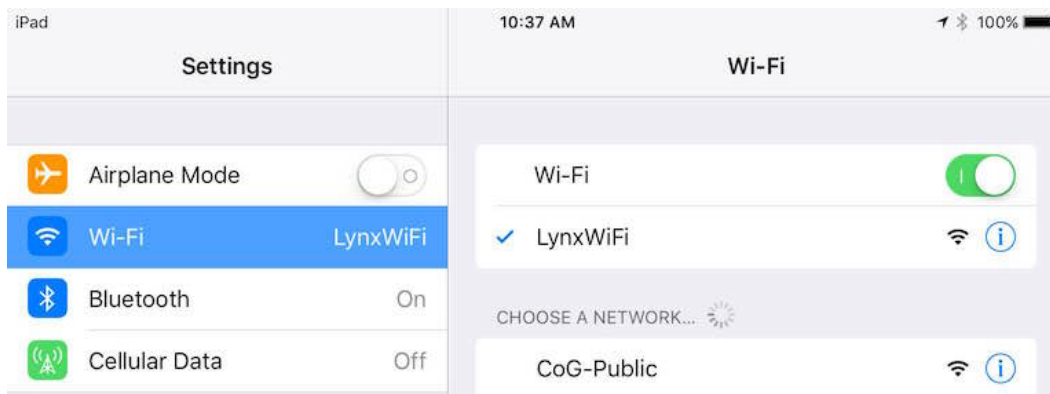

Using Lynx

Once you've joined the Lynx's Wi-Fi network, open ForeFlight and tap **More** > **Devices** to confirm the connection was recognized by ForeFlight and see what information is being received from the Lynx (see the note above if the Lynx is not appearing on this screen).

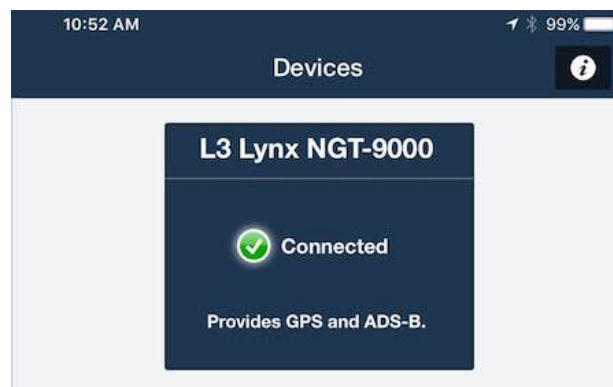

Tap the box to view the details of the Lynx and the data being received from it.

There are two settings that can be adjusted at the bottom of the Lynx status page:

- ❖ Logging - used only for diagnosing problems, this manages logging of the ADS-B data stream received by the Lynx. Leave this OFF normally, as it reduces app performance.
- ❖ Show ADS-B Towers - show the location on the Map of the ADS-B Towers currently being received.

GPS and ADS-B from Lynx

When GPS data is being sent from the Lynx to ForeFlight, the Accuracy instrument will show "Accuracy (L3 Lynx)." **NOTE:** Due to how ADS-B GPS accuracy is calculated and reported by the Lynx, the accuracy shown in ForeFlight may be worse than what it actually is. This is because the Lynx uses a limited number of "buckets" to report GPS accuracy to ForeFlight Mobile:

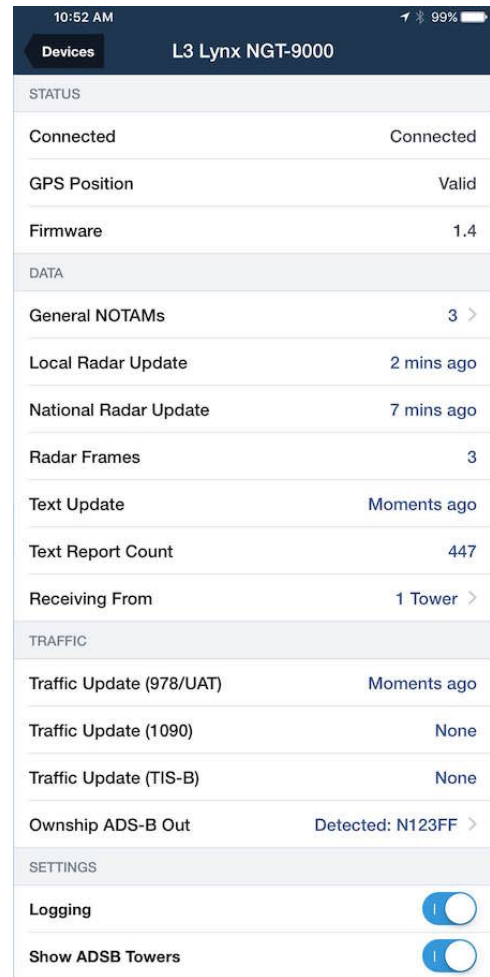

Lynx GPS Accuracy	GPS Accuracy shown in ForeFlight Mobile
Between 30m and >10m	30m
Between 10m and >3m	10m
3m or better	3m

When an ADS-B layer such as Radar or Traffic is selected on the Maps view, the number of ADS-B towers being received by the Lynx is shown in the upper-left corner of the view below the timestamp indicating when the last update was received.

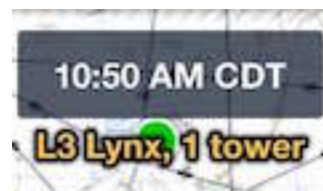
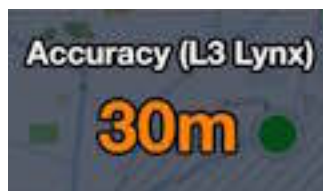

Avidyne IFD 550/540/440

ForeFlight can connect to Avidyne's IFD 550, 540, and 440 panel avionics via Wi-Fi to receive GPS position and flight plans sent to ForeFlight Mobile, and to send flight plans to the IFD 550/540/440. ForeFlight can also receive attitude information from the IFD 550 to power Synthetic Vision.

Connecting to IFD 540/440

After the Avidyne device has been installed in your aircraft and powered on, open Apple Settings > Wi-Fi and select "LIO_WiFi" to connect to the Avidyne's Wi-Fi network.

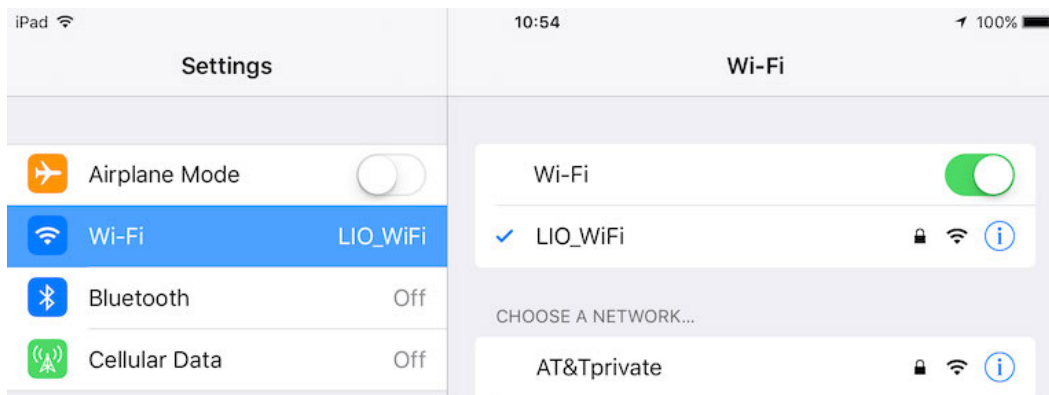

Getting a Route from IFD 550/540/440

Open ForeFlight and tap More > Devices to see the capabilities being provided by the Avidyne. Tap on the box to open the Avidyne's status page. If a route is currently loaded in the Avidyne it will appear at the bottom of the status page under Route. Tap on it to load the route into ForeFlight.

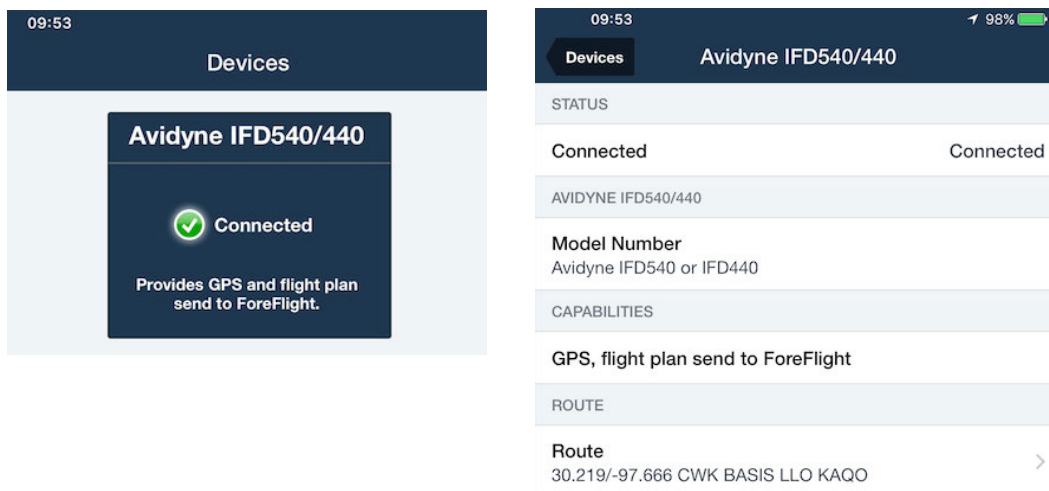

You can also load routes on an iPad from the Maps view: tap the Panel button at the top of the Maps view while connected to the Avidyne and tap "Load from Panel" to load the route into ForeFlight, and "Send to Panel" to send a route to the Avidyne.

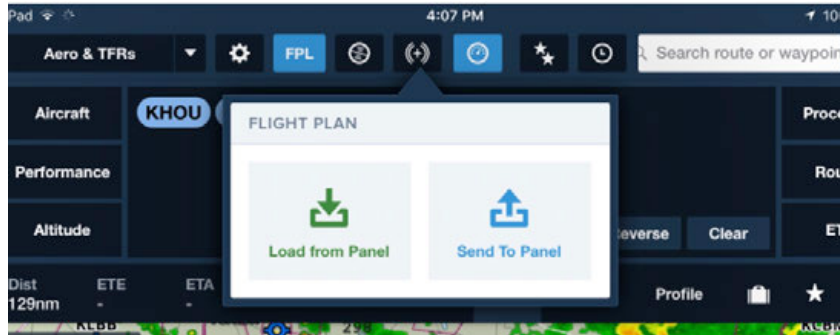

After tapping the "Send to Panel" button, on the Avidyne screen you will see a "Route Upload Ready" notification appear in the lower-right. Select the ROUTE page.

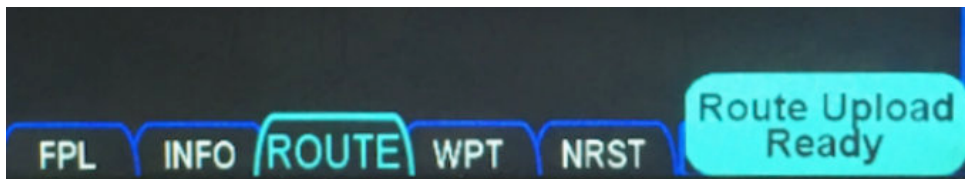

On the ROUTE page, search for your route in the list. The route may not be at the top of the list since routes are organized alphabetically by the "From" waypoint:

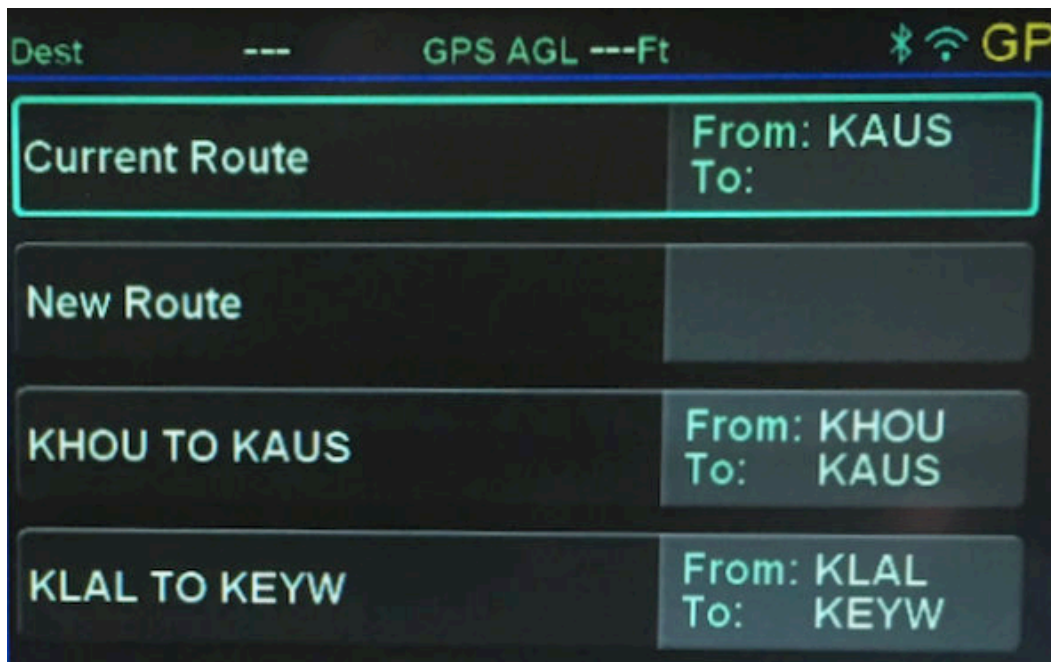

Select the route then choose the ACTIVATE ROUTE button on the left side of the screen. Confirm the route if you get a pop-up. You will now see the chosen route is activated on the Avidyne "FPL" page.

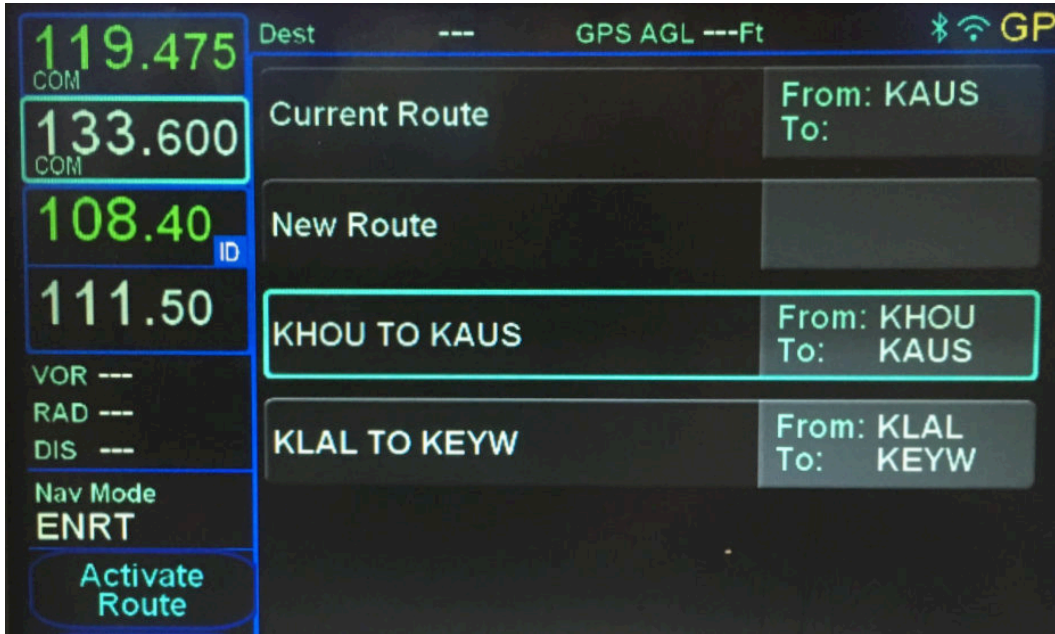

NOTE: If a route sent from the Avidyne contains waypoints not supported by ForeFlight Mobile they will appear in the app as Lat/Long waypoints:

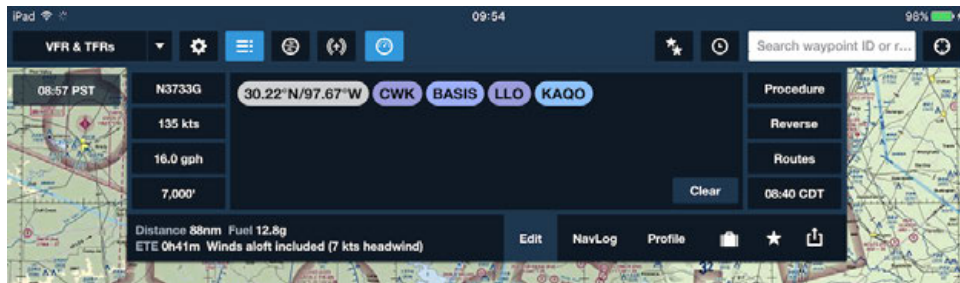

On an iPhone, tap Menu > Devices > Avidyne then tap the Route to load it into your NavLog.

GPS from IFD 550/540/440 and AHRS from IFD 550

When GPS data is being sent from the Avidyne to ForeFlight, the Accuracy instrument will show "Accuracy (Avidyne IFD540/440)", though some text will be cut out due to its length.



The AHRS data received from the IFD 550 can be used to power Synthetic Vision. The AHRS can only be calibrated within the IFD 550.

uAvionix echoUAT & SkyEcho

ForeFlight can connect to uAvionix's echoUAT and SkyEcho transceivers via Wi-Fi to receive ADS-B traffic and weather in ForeFlight, and the echoUAT also provides GPS position.

Connecting to echoUAT & SkyEcho

After either device has been installed in your aircraft, open **Apple Settings > Wi-Fi** and select "Ping-XXX" (where "XXXX" is some sequence of numbers and letters) to connect to the device's Wi-Fi network.

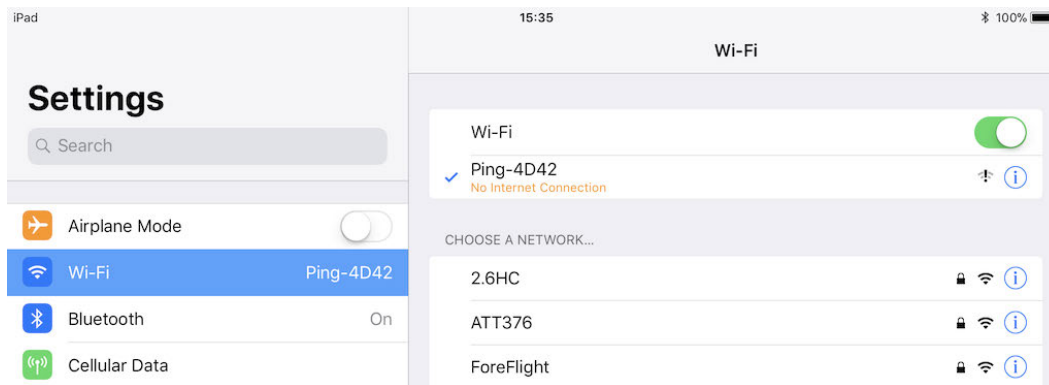

Using echoUAT & SkyEcho

Once you've joined the device's Wi-Fi network, open ForeFlight and tap **More > Devices** to confirm the connection was recognized by ForeFlight and see what information is being received from the device (both echoUAT and SkyEcho will appear as "uAvionix" in ForeFlight).

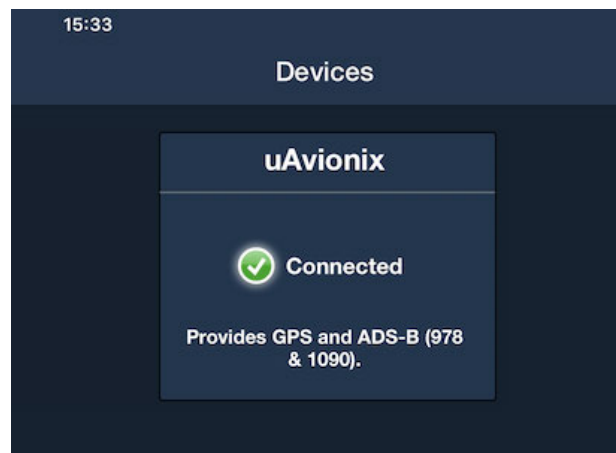

Tap the box to view the details of the device and the data being received from it.

There are three settings that can be adjusted at the bottom of the device's status page:

- ❖ Logging - used only for diagnosing problems, this manages logging of the ADS-B data stream received by the device. Leave this OFF normally, as it reduces app performance.
- ❖ Show ADS-B Towers - show the location on the Map of the ADS-B Towers currently being received.
- ❖ Use as GPS - turn ON to use the device's internal GPS to provide position data to ForeFlight. Turn this OFF if you'd rather receive GPS data from another connected device or from your iPad/iPhone's internal GPS.

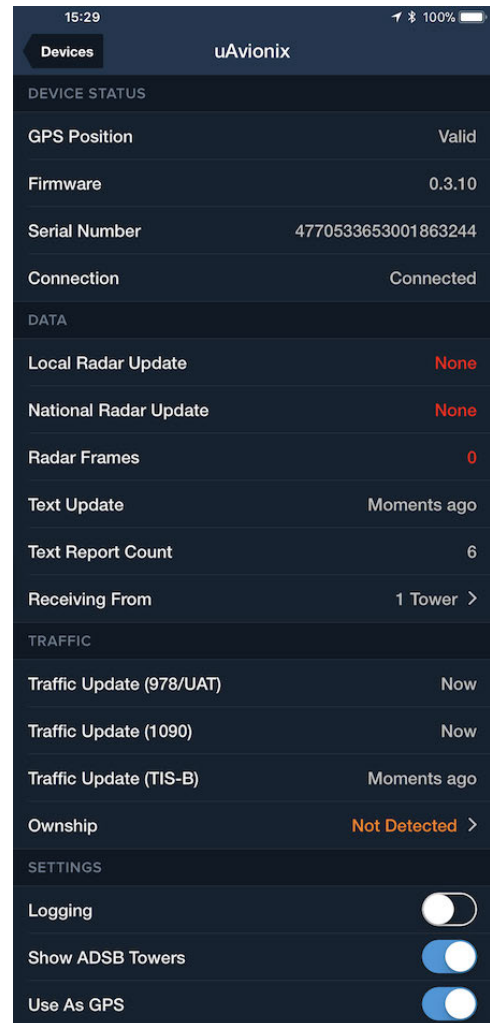

GPS and ADS-B from echoUAT & SkyEcho

When GPS data is being sent from the device to ForeFlight, the Accuracy instrument will show "Accuracy (uAvionix)." When an ADS-B layer such as Radar or Traffic is selected on the Maps view, the number of ADS-B towers being received by the device is shown in the upper-left corner of the view below the timestamp indicating when the last update was received.

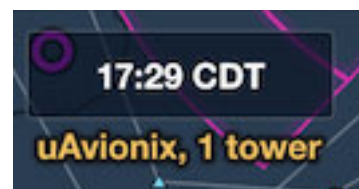

Dynon SkyView

ForeFlight has partnered with Dynon Avionics to bring secure WiFi connectivity between ForeFlight Mobile and the Dynon SkyView glass panel avionics system. This connectivity allows flight plans to be transferred between ForeFlight Mobile and the SkyView, and for ForeFlight Mobile to receive GPS and AHRS data from the SkyView.

To connect your ForeFlight Mobile with your Dynon SkyView, you will need:

- ❖ A Dynon WiFi adapter for each SkyView screen.
- ❖ SkyView version 12.0 or later in each SkyView screen.
- ❖ ForeFlight Mobile version 6.7 or later.

Configuring SkyView WiFi

See the SkyView documentation for instructions on installing and configuring the SkyView WiFi adapter and setting the network password.

Connecting ForeFlight and SkyView

With the SkyView system ON, open Apple Settings > WiFi and tap the SkyView-XXXXX WiFi network, then enter the password to connect.



IMPORTANT: If your iPad has the Cellular Data option it should be switched **OFF**. iPhones should have **Airplane Mode** switched **ON**, with **WiFi** then turned back **ON**.

Sending a Route to SkyView

On an iPad, open the Flight Plan Editor, tap the "Send to" button and tap "Panel", or tap the Panel button at the top of the Maps view and tap "Send to Panel."

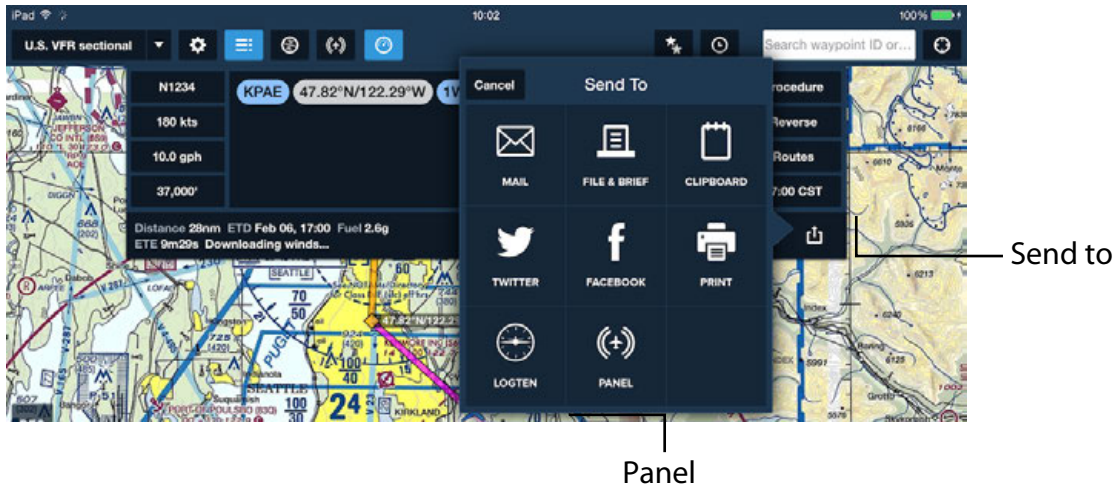

On an iPhone, tap Menu, scroll to the Route section and choose the Route. Then tap the "Send to" button in the bottom-right and tap "Panel."

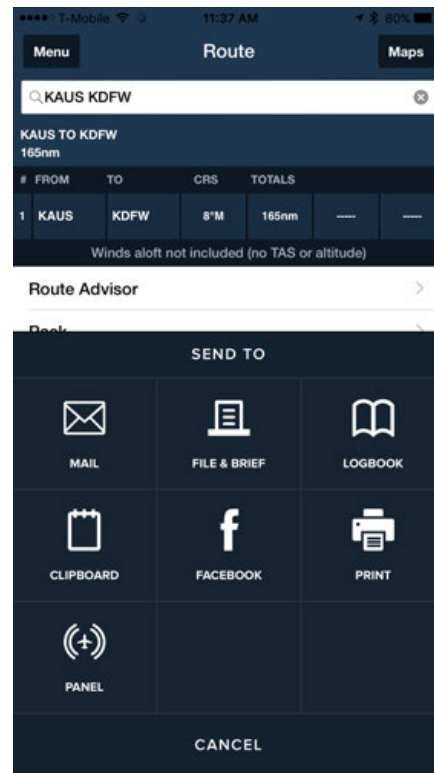
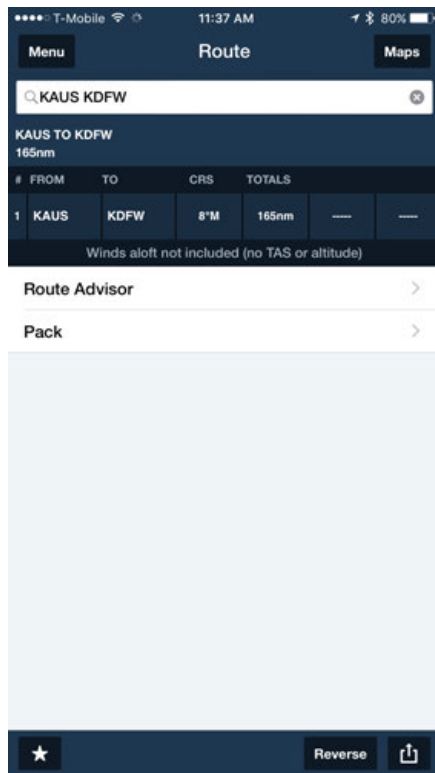

After sending the route a pop-up will open in ForeFlight confirming that the route has been successfully sent to the SkyView. Tap "OK" to dismiss the pop-up.

A pop-up will also open on the SkyView indicating that the route has been successfully received.

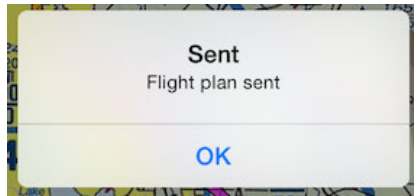

Getting a Route from SkyView

You can view if SkyView has a route available to send to ForeFlight Mobile on an iPad in More > Devices > SkyView > Route; or on the Maps view, tap the Maps “Settings” button  and scroll to the bottom of the menu. Then tap the “SkyView” entry at the bottom of the list. On an iPhone, look in Menu > Devices > SkyView > Route.

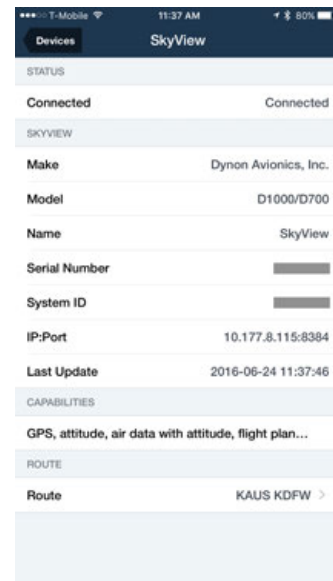
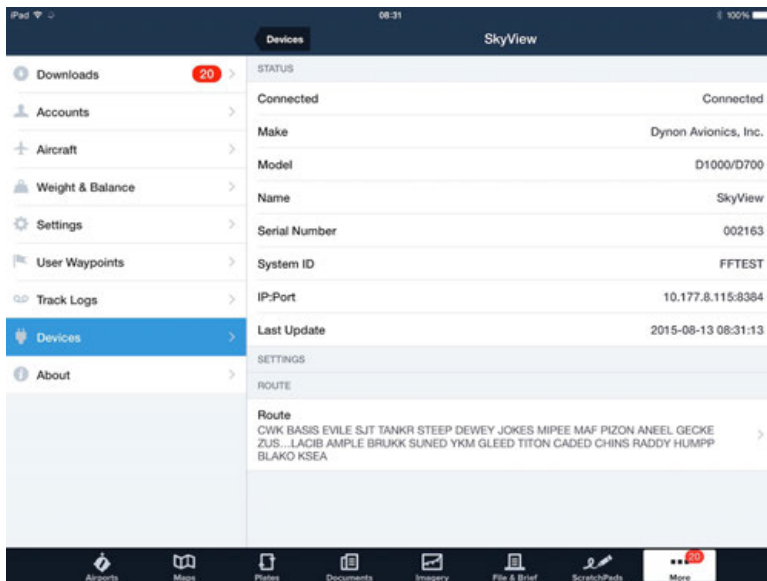

To transfer a route from a SkyView to an iPad, tap the “Panel” button at the top of the Maps view and tap “Load from Panel.” You can also load a route shown on the SkyView status page in More > Devices > SkyView by tapping the route.



Panel

On an iPhone, tap Menu > Devices > SkyView then tap the Route to load it into your NavLog.

GPS and ARHS data from SkyView

When GPS data is being sent from the SkyView to ForeFlight Mobile, the Accuracy instrument will show "Accuracy (SkyView)."



When AHRS data is being sent from SkyView to ForeFlight Mobile, the ARHS source (displayed by tapping the "Gear" button above "AHRS") will show as SkyView.

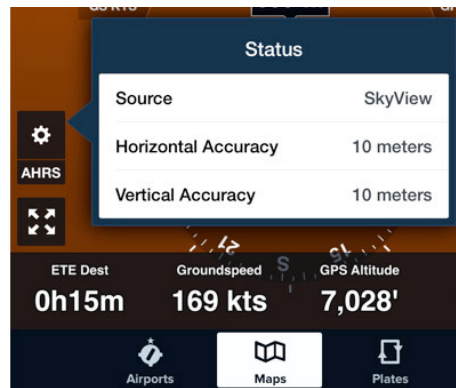

ForeFlight Mobile will be receiving the same AHRS data as is displayed on the SkyView screen(s) so no additional AHRS calibration is necessary in ForeFlight Mobile.

FreeFlight ADS-B

FreeFlight can receive ADS-B weather and Traffic data, as well as GPS position data from appropriately-equipped FreeFlight RANGR ADS-B systems.

Connecting FreeFlight and FreeFlight RANGR

After connecting to the FreeFlight RANGR WiFi network using Apple Settings > WiFi, tap More > Devices to confirm the FreeFlight box is displayed.

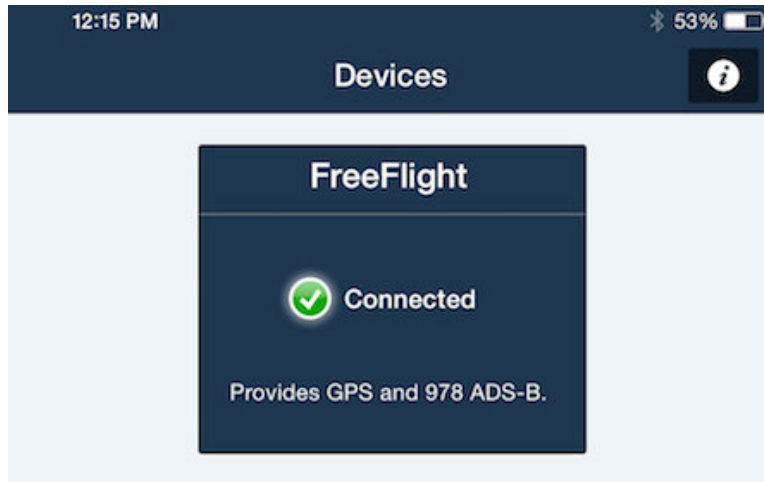

Tap the FreeFlight box to see detailed information and settings for the FreeFlight RANGR.

The screenshot shows the detailed information for the 'FreeFlight' device. The status is 'Connected'. The GPS position is 'Valid'. The temperature is 42.5°C. The input voltage is 11.91V and the internal voltage is 4.95V. The boot loader version is 1.0.1.80, the application version is 1.9.1.187, and the firmware version is 1.2. The GPS version is 1.10. The local radar update was received 'Moments ago'.

STATUS	
Connected	Connected
GPS Position	Valid
Temperature	42.5°C
Input Volts	11.91V
Internal Volts	4.95V
Boot Loader	1.0.1.80
Application	1.9.1.187
Firmware	1.2
GPS	1.10
DATA	
Local Radar Update	Moments ago

GPS and ADS-B data from FreeFlight RANGR

When GPS data is being provided by the RANGR, the Accuracy instrument will show (FreeFlight).



When an ADS-B layer such as Radar or Traffic is selected on the Maps page, the number of ADS-B towers being received by the FreeFlight RANGR is shown in the upper-left corner of the page below the timestamp indicating when the last update was received.

SiriusXM SXAR1

ForeFlight Mobile supports the SiriusXM SXAR1 portable, battery-powered weather receiver when used with a “Pilot for ForeFlight” SiriusXM weather data subscription. To purchase that subscription from SiriusXM, call SiriusXM Aviation at 1-855-838-8563 or visit www.siriusxm.com/foreflight.

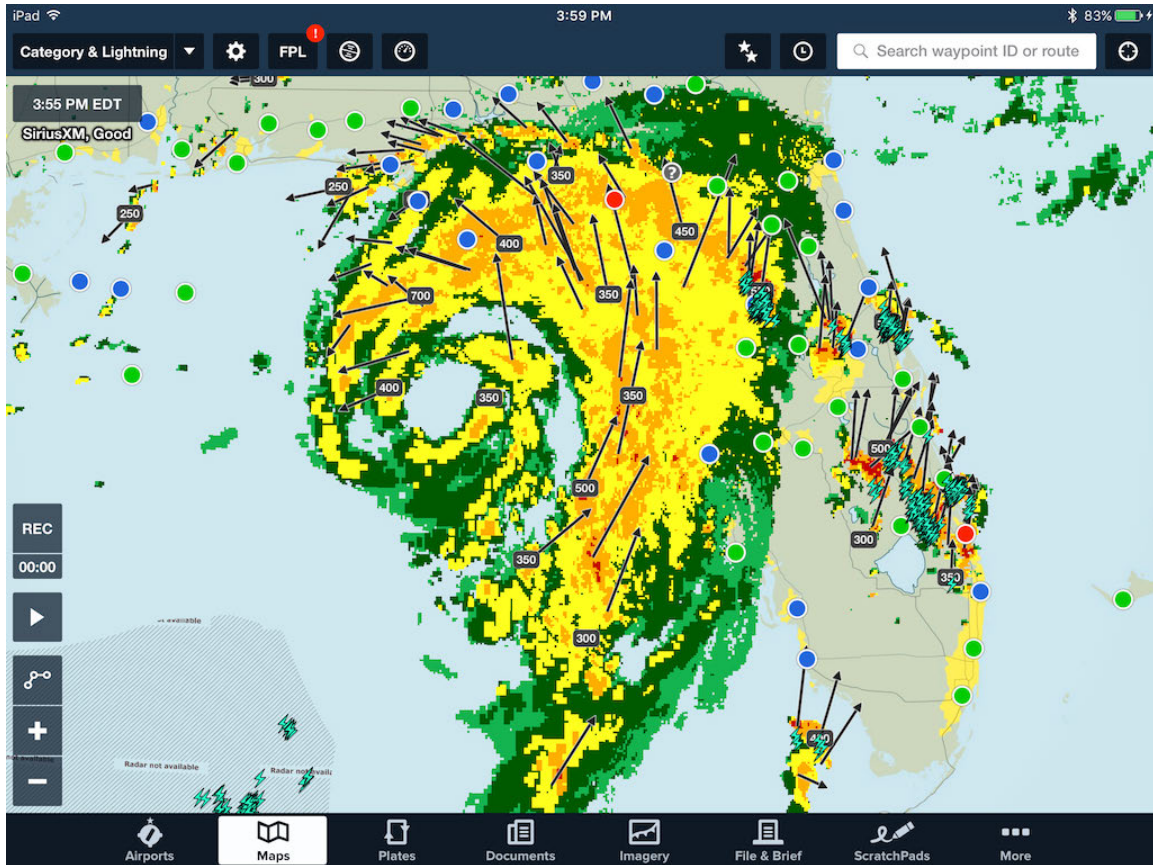

Connecting ForeFlight to the SXAR1

The SXAR1 uses Bluetooth to connect to a single iPad or iPhone at a time; simultaneous connections to multiple iPads or iPhones are not currently supported.

To pair your iPad or iPhone with SXAR1 turn the SXAR1 ON and once the lights on top start to illuminate, open Apple Settings and go to the Bluetooth section.

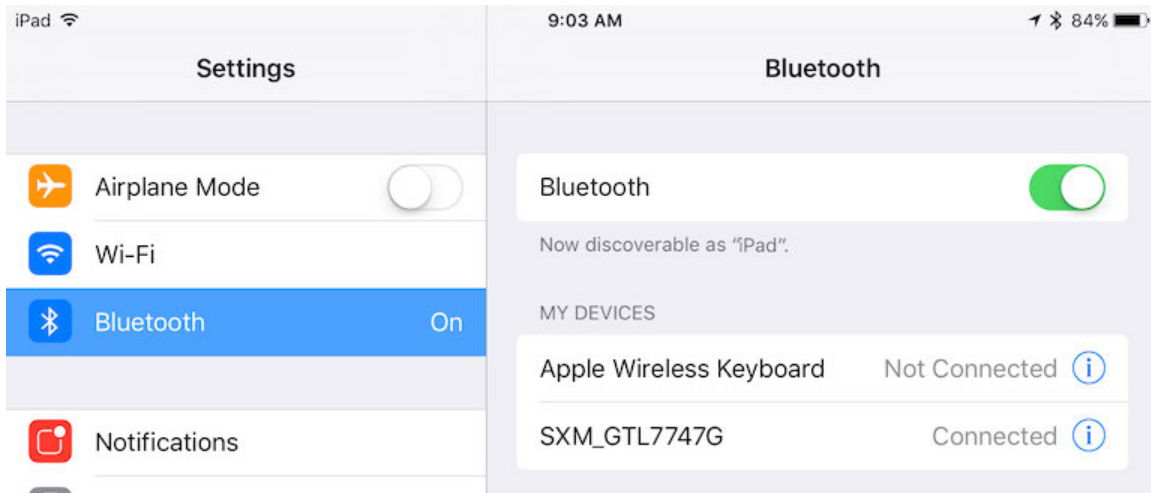

Tap the SXM_##### entry to pair with your iPad. NOTE: The letters and numbers after "SXM_" in the list of Bluetooth devices are your RadioID, which may be needed when subscribing, re-activating, or resetting your "Pilot for ForeFlight" SiriusXM weather data subscription.

SXAR1 Available Weather Data

ForeFlight Mobile can display these weather data items from the SXAR1:

- ❖ High Resolution Composite (NEXRAD) Radar, including coverage of areas of southern Canada and northern Mexico
- ❖ High Resolution Lowest-tilt (NEXRAD) Radar, including coverage of areas of Canada and northern Mexico
NOTE: for either Composite or Lowest Tilt radars, see radar color vs. intensity legends for [Rain](#), [Mixed Rain/Snow](#), and [Snow](#).
- ❖ NEXRAD Storm Cell Attributes and track markers.
- ❖ Echo Tops, covering CONUS, northern Mexico, and southern Canada.
- ❖ Cloud Tops, covering CONUS, northern Mexico, and southern Canada.
- ❖ Icing NOWcast, covering CONUS, northern Mexico, and southern Canada.
- ❖ Turbulence, covering CONUS, northern Mexico, and southern Canada.

- ❖ Surface Analysis, covering almost all of North and Central America (excluding northernmost Canada and Alaska) and as far west as Hawaii.
- ❖ Surface Wind - derived from METARs at Airports, shows wind speed and direction at those locations only.
- ❖ [Surface Wind Analysis](#) - derived from a forecast model, shows wind speed and direction at 10 meters above the surface at tens of thousands of evenly spaced points across the country.
- ❖ Lightning
- ❖ Temporary Flight Restrictions (TFRs) on Maps **SEE IMPORTANT NOTICE BELOW**
- ❖ Winds Aloft — Graphical
- ❖ Temperatures Aloft
- ❖ Dewpoint spread
- ❖ METARs/TAFs
- ❖ AIRMETS/SIGMETS
- ❖ PIREPS
- ❖ Radar Coverage Map

TFRs IMPORTANT NOTICE:

While using a SXAR1 receiver, up-to-date graphical TFR information is ONLY displayed if you select the TFR Map layer.

However if the FAA publishes a TFR without associated graphical shape information it may not be possible for ForeFlight Mobile to show the graphical TFR on the Maps page.

Therefore you should also check the Airports page, under NOTAMs > TFRs for airports along your route, and contact ATC or FSS to confirm that your route does not cross any such TFRs

TFR data may not be updated or displayed if your iPad is “asleep”, is not connected to the SXAR1, if the SXAR1 receiver is not receiving data from XM satellites, or if the XM satellite data does not include information about that TFR.

Storm cell attributes show the height of the cell in 100's of feet. Tap the marker to view details about the speed and direction of travel. Storm cell track markers show the projected direction of travel of the cell, and where it is projected to be in 20, 40, and 60 minutes from the time of the Radar update.

The storm cell track markers, storm cell attributes, and other weather symbols (see below) are all based on the latest Radar frame received, so do not animate if you tap the Radar 'play' button.

Tap on other weather symbol, such as Hail, to view additional details.

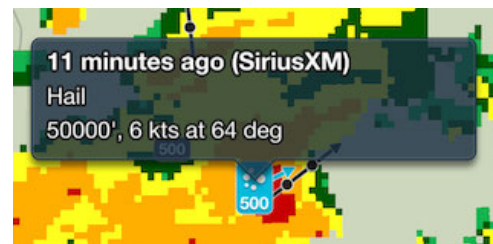
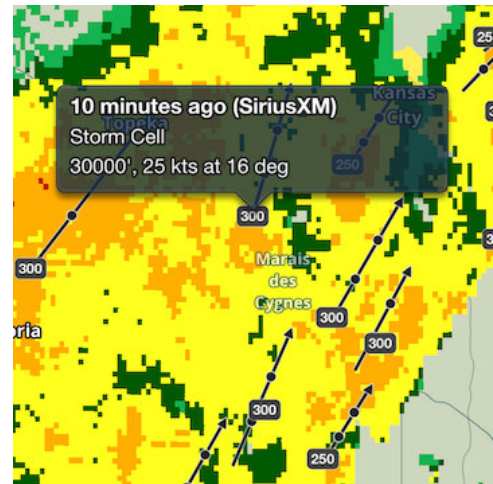

SXAR1 Status Information

Tap More > Devices > SXAR1, or from the Maps page tap the Maps Settings (gear) button and scroll down to SXAR1, to see device status and settings.

There are four settings that can be adjusted at the bottom of the SXAR1 status page:

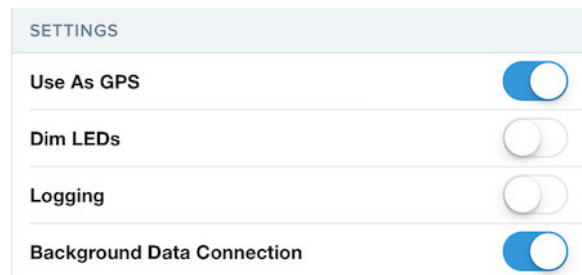

- ❖ Use as GPS - turn ON to use the SXAR1's internal GPS to provide position data to ForeFlight. Turn this OFF if you'd rather receive GPS data from another connected device, such as a Stratus 2S.
- ❖ Dim LEDs - turn ON to dim the SXAR1's status lights, which helps preserve battery life and reduces brightness when flying at night.
- ❖ Logging - used only for diagnosing problems, this manages logging of XM data stream received by SXAR1. Leave this OFF normally, as it reduces app performance.

❖ Background Data Connection - when ON, SXAR1 will continue to send updated weather data to ForeFlight even when it is in the background. We recommend leaving this ON, because turning it OFF can result in the loss of Bluetooth connection to SXAR1 if ForeFlight is kept in the background.

SiriusXM Satellite Radio

With a SiriusXM Satellite Radio subscription, an add-on to the “Pilot for ForeFlight” SiriusXM weather data subscription, you can listen to SiriusXM radio while in-flight via a Bluetooth audio device. This can be a single headset with Bluetooth audio, or an intercom with Bluetooth audio interface, or a Bluetooth audio adapter plugged-in to a “music-in” jack in your aircraft’s panel and wired-in to the intercom.

IMPORTANT: the SiriusXM satellite radio does NOT play directly through the iPad or iPhone speaker or headphone jack. You MUST connect a Bluetooth audio device per the instructions below.

Playing a satellite radio stream is controlled by the interface in ForeFlight Mobile, but the audio is sent directly from the SXAR1 to the Bluetooth audio device. This means the audio will continue to play if you sleep ForeFlight Mobile.

To add SiriusXM Audio to your existing subscription, call 855-838-8563 or visit https://care.siriusxm.com/login_view.action to upgrade. For more information about the “Pilot for ForeFlight” plan, visit <https://www.siriusxm.com/foreflight>.

After adding the subscription to your plan, you will see “Audio: Active >” below the ForeFlight subscription in More > Devices > SXAR1.

DEVICE INFORMATION	
Radio ID	GTL7747B
Subscription	ForeFlight
Audio	Active >

If “Active” does not show, position the SXAR1 so it has a clear view of the sky, then send a refresh signal to your radio by visiting <http://www.siriusxm.com/refresh>.

Connecting a Bluetooth audio device to the SXAR1

To listen to satellite radio programming you must connect a Bluetooth audio device to the SXAR1. To begin the connection process, tap More > Devices > SXAR1 > Audio, or on the Maps page tap the Maps Settings button, then scroll down to the SXAR1 and tap the "Audio >" line.

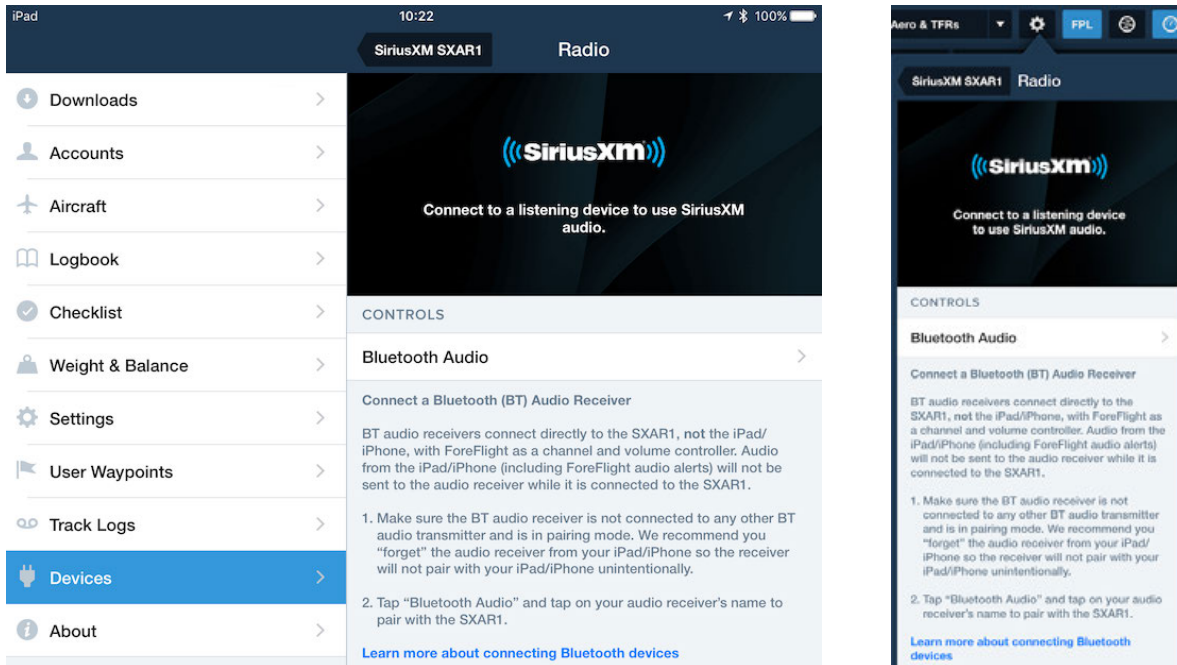

To connect to a Bluetooth audio device for the first time, turn it on and make sure it is in pairing mode. If that Bluetooth audio device was previously paired to your iPad or iPhone, you should "forget" that pairing in Apple Settings so that the device will be available to connect to the SXAR1. **NOTE:** many Bluetooth audio devices automatically enter pairing mode when first turned-on, as long as no other previously-paired devices are nearby.

Once the Bluetooth audio device is on and in pairing mode, tap "Bluetooth Audio" to initiate the connection from the SXAR1 to the Bluetooth audio device.

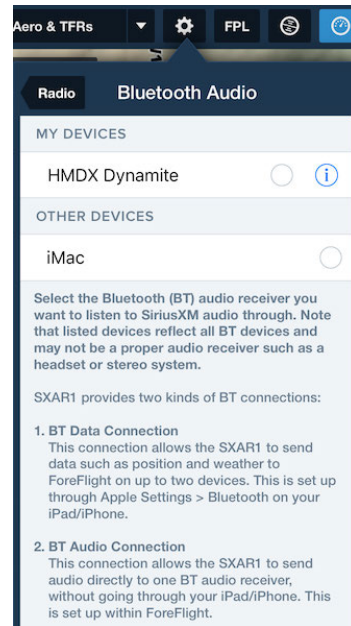
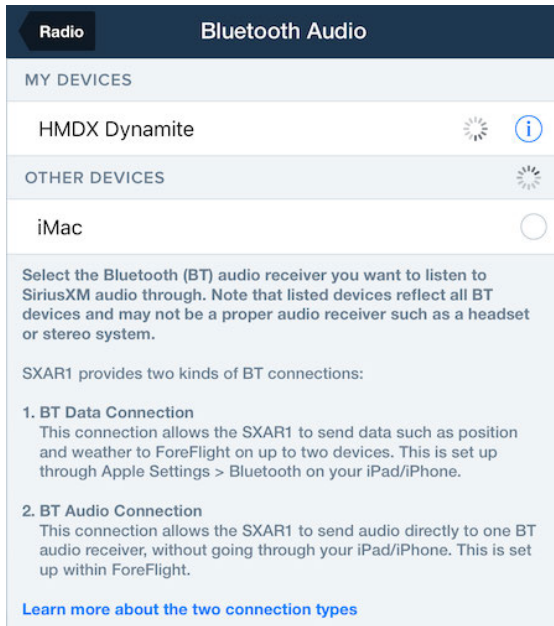

Tap the name of the device to which you would like the SXAR1 to connect. The “spinner” will appear and when the pairing is complete, the connected device will show in the “My Devices” section and audio should begin playing. To disconnect the device, or to forget it completely (which would require re-pairing) tap the “i” next to the device name, then choose the desired option.

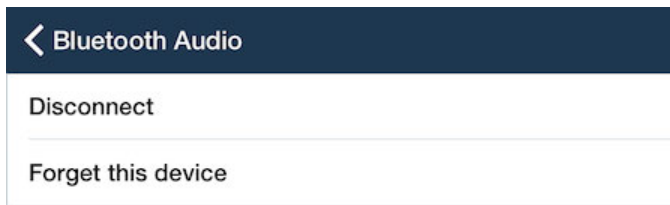

SXAR1 Audio Controls

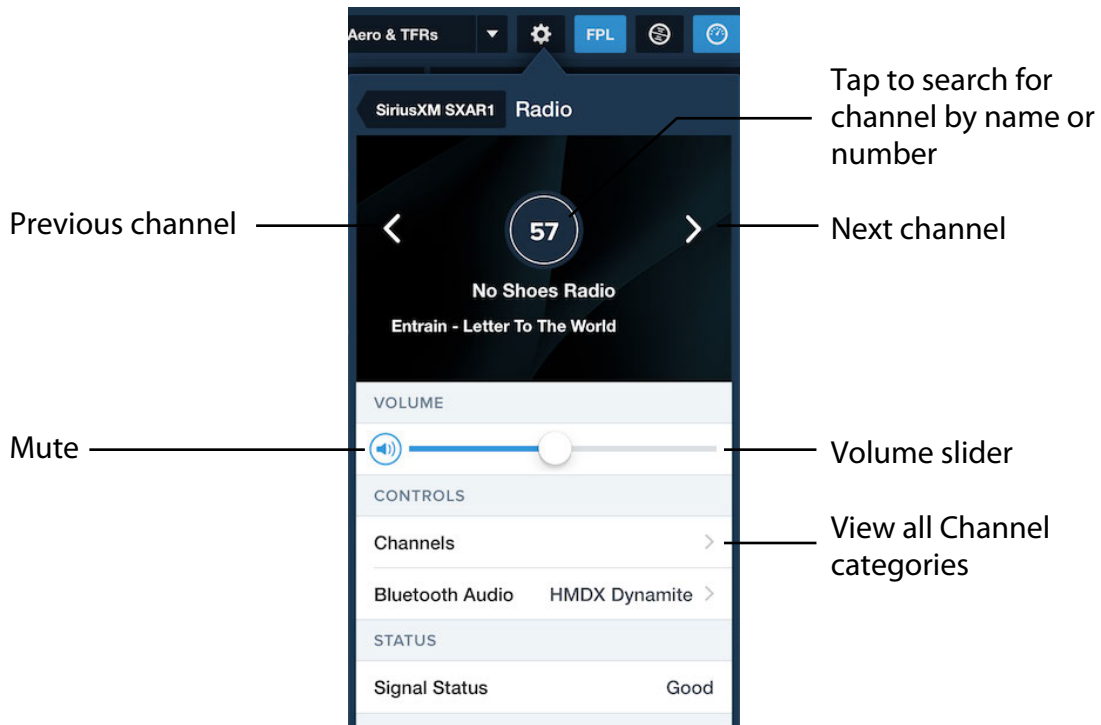

You can tune to a new channel by tapping the Category then Channel, or by typing the Channel number or name (full or partial) in the "Tune or Search" box. A vertical scroll bar shows when there are more Channels or Categories than can be shown, and blue speaker icon shows in the currently-playing Category and Channel.

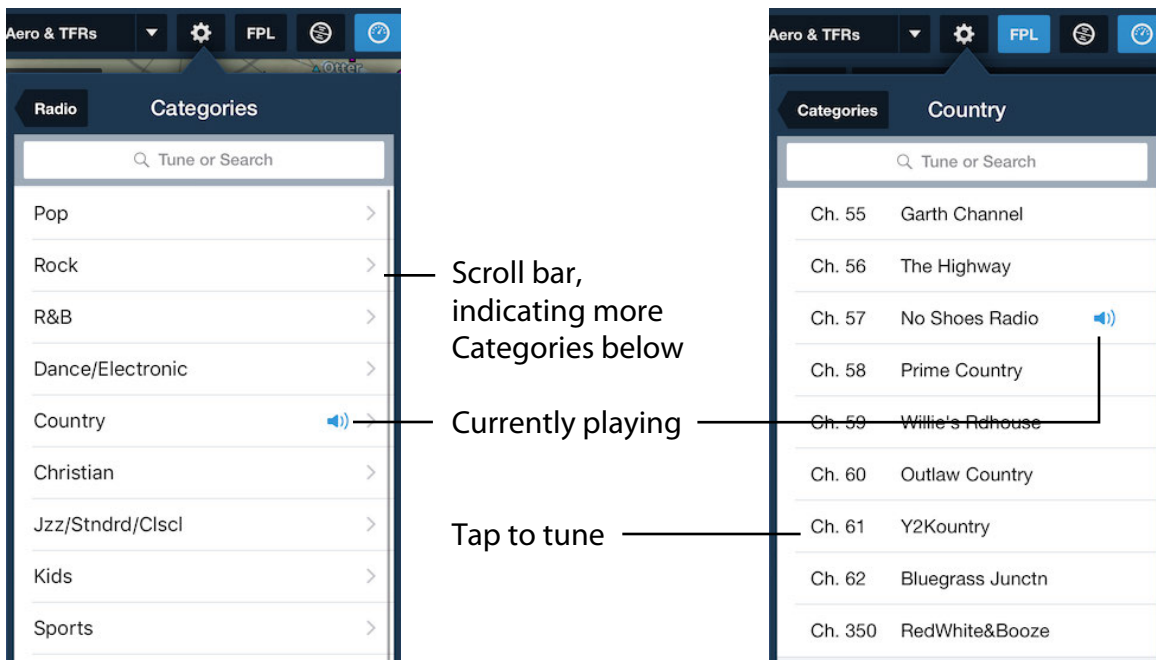

Search by Channel name or number

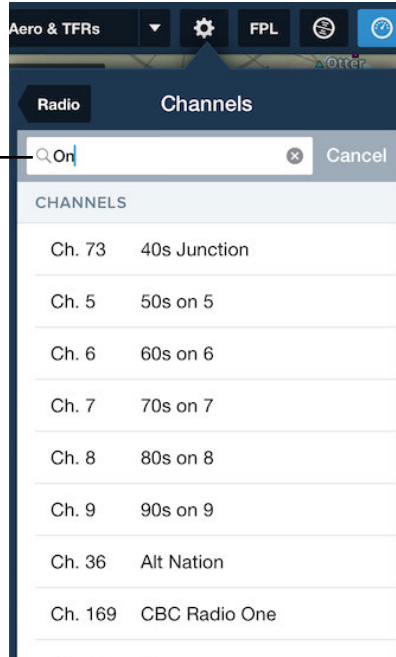

For additional information about ForeFlight's support for SiriusXM Satellite Radio and troubleshooting tips, visit <https://foreflight.com/connect/siriusxm/support/>.

Baron Mobile Link/WXWorx

The Baron Services Mobile Link plugs-in to a WXWorx XM WX receiver, and provides a WiFi connection so that ForeFlight Mobile can access the XM WX data. Please consult the Mobile Link documentation to learn how to setup and connect the device.

The Mobile Link firmware 2.0 or higher allows data access to up to 4 devices at a time. ForeFlight Mobile attempts to get data access whenever it is launched and again any time data is requested by the user. ForeFlight Mobile will release its access when the app is closed via the physical home button.

If a device or app has gained access to the data and does not release it properly, the Mobile Link will automatically release the access for that device after 60 seconds.

The Mobile Link status view in ForeFlight Mobile will state whether data access has been obtained, see the "Status information" section below for more information.

Mobile Link Available Weather Data

ForeFlight Mobile can display these weather data items from the Baron Mobile Link/WXWorx:

- ❖ Radar - for any subscribed region, shown on Maps. See [radar color vs. intensity legend](#).
- ❖ Satellite - for any subscribed region, shown on Maps
- ❖ METARs and METAR-derived data shown on Maps, such as temperature
- ❖ TAFs
- ❖ Winds Aloft
- ❖ TFRs on Maps **SEE IMPORTANT NOTICE BELOW**
- ❖ PIREPs on Maps
- ❖ AIRMETs/SIGMETs on Maps
- ❖ Lightning on Maps (requires Mobile Link firmware version 2.0 or higher)

Data is accessed just as it is when on the ground using an Internet connection. There is no user-configuration required beyond ensuring the Wi-Fi connection to the Mobile Link is properly established.

TFRs IMPORTANT NOTICE:

While using a Baron Mobile Link XM WX receiver, up-to-date graphical TFR information is ONLY displayed if you select the TFR Map layer.

However if the FAA publishes a TFR without associated graphical shape information it may not be possible for ForeFlight Mobile to show the graphical TFR on the Maps page.

Therefore you should also check the Airports page, under NOTAMs > TFRs for airports along your route, and contact ATC or FSS to confirm that your route does not cross any such TFRs

TFR data may not be updated or displayed if your iPad is “asleep”, is not connected to the Baron Mobile Link, if the Baron Mobile Link receiver is not receiving data from XM satellites, or if the XM satellite data does not include information about that TFR.

Mobile Link Status Information

To learn the status of the Mobile Link connection, subscription, data availability and more, please use the Devices view as described above. When connected to the Mobile Link Wi-Fi access point, Mobile Link will be an option shown in the Devices view. Tap it to see full status information. This information is useful for troubleshooting if you experience problems with the Baron Mobile Link/WXWorx combination.

Satcom Direct Router (SDR)

All customers can connect to SDR to receive in-flight internet data in ForeFlight, but customers with a Performance Plus or Business Performance plan can also receive GPS and indicated altitude from SDR, in addition to having more control over the device's internet settings.

Connecting to SDR

To connect to the SDR's Wi-Fi network, open **Apple Settings** > **Wi-Fi** and select "SDR-XXX", where "XXX" is the router's serial number.

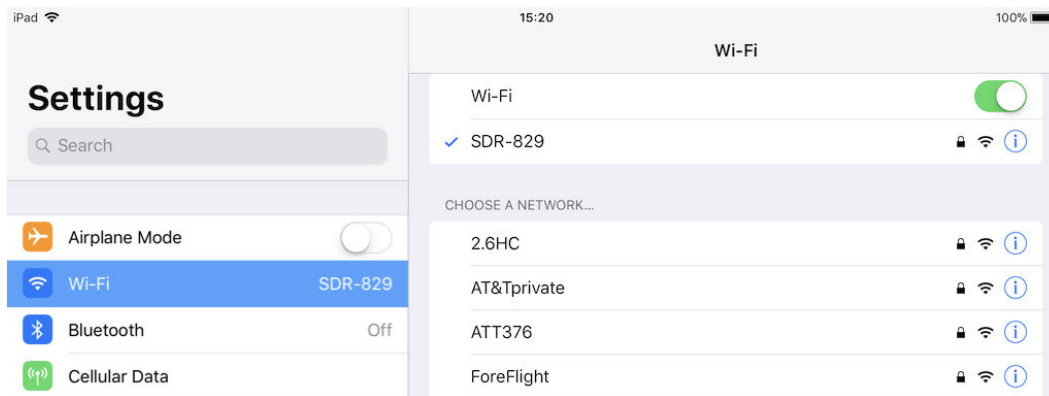

Using SDR

Once you've joined the SDR's Wi-Fi network, open ForeFlight and tap **More** > **Devices** to confirm the connection was recognized by ForeFlight and see what information is being received from the SDR.

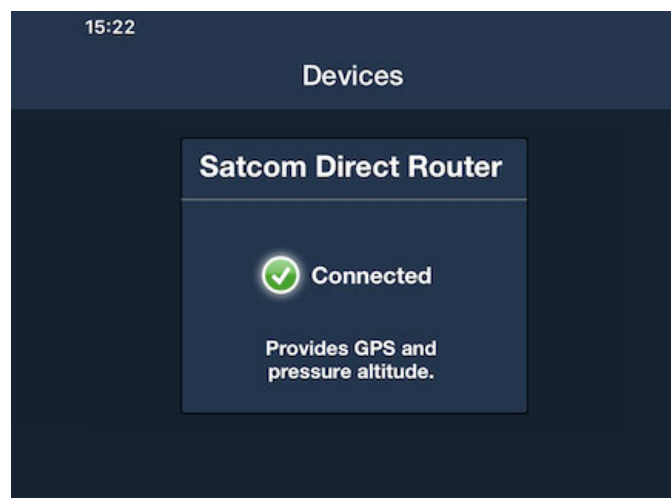

Tap the box to view the details of the SDR and the data being received from it.

There are three settings that can be adjusted at the bottom of the SDR status page:

- ❖ Allow ForeFlight to access the Internet - turn this OFF to prevent ForeFlight from using internet data from the SDR, reducing inflight bandwidth usage and associated costs. This setting is ON by default.
- ❖ Logging - used only for diagnosing problems, this manages logging of the data stream received by the SDR. Leave this OFF normally, as it reduces app performance.
- ❖ Use as GPS - turn ON to use your aircraft's GPS data routed through the SDR to provide position data to ForeFlight. Turn this OFF if you'd rather receive GPS data from another connected device or from your iPad/iPhone's internal GPS. **NOTE:** the SDR supplies GPS lat/long and groundspeed data, but it may not provide GPS altitude or GPS track, depending on the SDR's firmware.

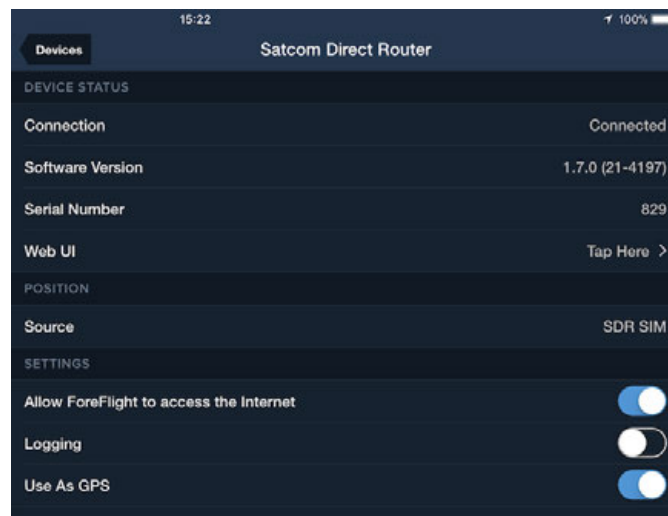

Tap the "Web UI" line to access the SDR LAN network administrator page on Safari.

GPS and Pressure Altitude from SDR

When GPS data is being sent from the SDR to ForeFlight, the Accuracy instrument will show "Accuracy (A429)". When Pressure Altitude data is being sent from the SDR to ForeFlight, the Pressure Altitude instrument will say "Pressure Altitude (A429)", and will have a "Indicated" tag underneath, indicating that the value represents actual indicated altitude.

LogTen Integration

ForeFlight Mobile can export routes or flight plans to the LogTen app, when LogTen is installed. To create a new logbook entry in LogTen based on a route, create the route on the Maps view and tap the **Send To** button in the Navigation Log. This will show LogTen as one option. Tap that to open LogTen and create a new log entry.

Logbook entries can also be created from the Flights view, once LogTen is installed on the iPad. Run ForeFlight Mobile, go to Flights and select the plan to export. Tap the blue LogTen button below the flight plan details list on the right to open LogTen with a new logbook entry.

Flight Simulator Integration

Before Using a Flight Simulator with ForeFlight Mobile

The iPad (or iPhone) running ForeFlight Mobile must be on the same network as the flight simulator. Both the iPad running ForeFlight Mobile and the flight simulator can be connected to the network using WiFi, or the flight simulator computer can be connected to the WiFi router via Ethernet cable, while the iPad is connected via WiFi.

After setting-up a compatible flight simulator and activating its data connection (see below for instructions for popular flight simulators) open ForeFlight Mobile, tap **More > Devices**, then tap on the box containing the name of the flight simulator and slide the “Enabled” switch to ON.

For example if using X-Plane, in ForeFlight Mobile tap **More > Devices**, then tap the “X-Plane” box, then switch the Enabled switch ON:

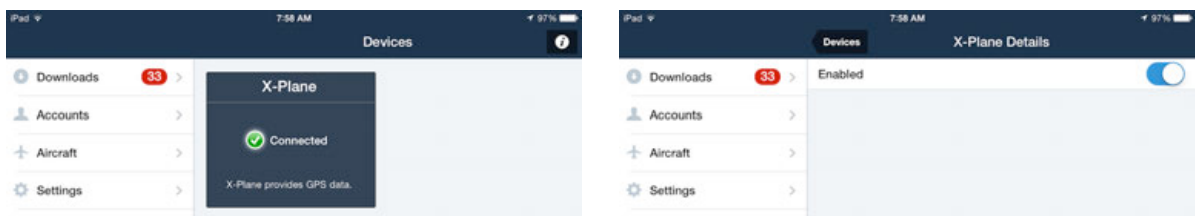

After connecting the flight simulator and turning the Enabled switch ON, verify that the iPad or iPhone is receiving simulated GPS data from the flight simulator by displaying the Accuracy instrument on the Instrument Panel on the Maps page.

X-Plane

ForeFlight Mobile can receive GPS input from the X-Plane flight simulator v10.11 or newer on any supported platform. To enable this feature in X-Plane, bring up the **Settings > Net Connections** menu. Change to the iPhone/iPad tab and check the appropriate ForeFlight box.

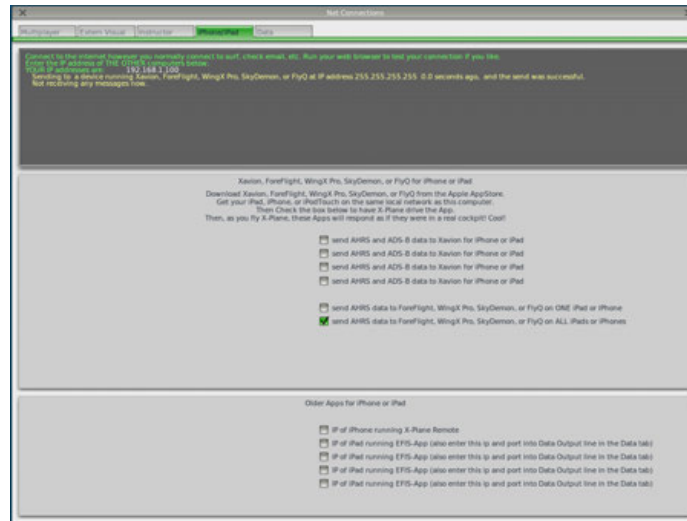

Infinite Flight

Infinite Flight (<http://www.infinite-flight.com>) is a flight simulator available for iOS (iPhone and iPad) and Android (phone and tablet). Infinite Flight version 15.04 or later (either iOS or Android) is able to send simulated position, attitude and traffic data to ForeFlight Mobile running on an iPad or iPhone, provided both devices are connected to the same WiFi network.

Open Infinite Flight, tap the “Gear” button in the upper-left corner , then scroll down to the bottom of the list and tap the “Enable ForeFlight Link” switch ON.

If you are using Infinite Flight Live (additional charge), you can see the other traffic in your area in ForeFlight Mobile by tapping the Maps drop down and enabling the Traffic layer.

If Synthetic Vision is included in your ForeFlight subscription, tap the “AI” button to enable the SV split-screen view showing color coded obstacles and terrain.

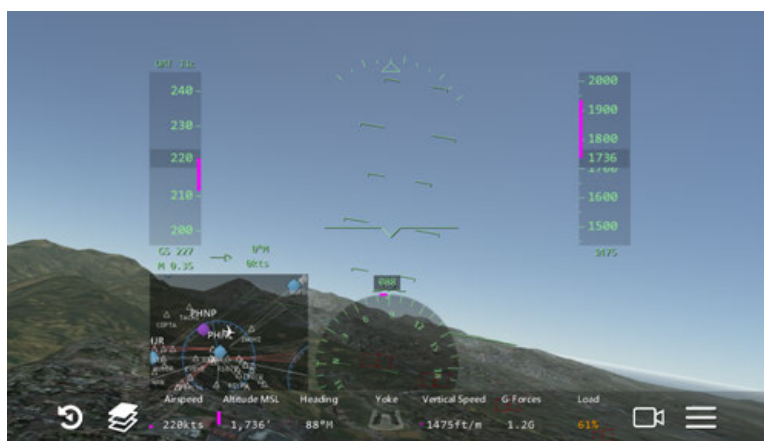
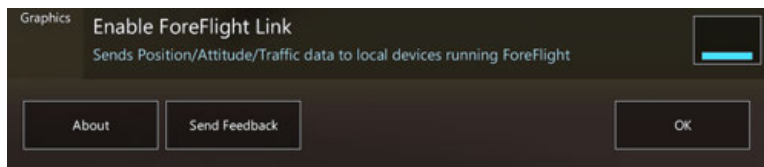

Prepar3D/Flight Simulator X

ForeFlight Mobile can receive GPS input from the Prepar3D or Flight Simulator X flight simulators over a WiFi network when the FSXFlight plug-in is installed on the flight simulator computer. For more information and instructions visit www.fsxflight.com.

Pilots who prefer a wired option can use the Cygnus Home Direct. For more information, visit www.kingschools.com/pilot-supplies/flight-simulator/iPad-connection-wired

Redbird

ForeFlight Mobile can receive GPS input from a Redbird simulator via the Cygnus Pro Wireless connection. For more information visit www.kingschools.com/pilot-supplies/flight-simulator/iPad-connection-bluetooth

ELITE

ELITE 8.6 (Core, Premium, PCATD, BATD or AATD) can send GPS input to ForeFlight Mobile using the ELITE “Sim to App” iPad Connection Software, available for purchase at www.flyelite.com/shop/sim-to-app-2/

After installing the add-in, follow the included instructions to activate the connectivity with ForeFlight Mobile. NOTE: on the ELITE iPad Configuration screen in the ForeFlight box, press the “SEND” button corresponding either with Broadcast (to all iPads on your network) or to specific devices based on IP address.

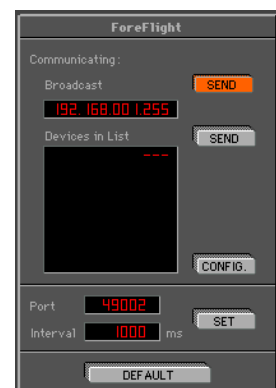

AeroFly FS 2

AeroFly FS 2 for the PC supports sending GPS position data to ForeFlight Mobile. To activate, first identify the IP address of your iPad by tapping **More > Devices**, then tap the “i” in the upper right hand corner of the screen. Record the numbers of the IP address labeled “Wi-Fi”; they will look something like this example: 192.168.1.119

Open AeroFly FS 2 Miscellaneous Settings, enter your iPad IP address into the “Broadcast IP address” box. Make sure the Broadcast IP port is set to: 49002, then click the “Broadcast flight info to IP address” ON.

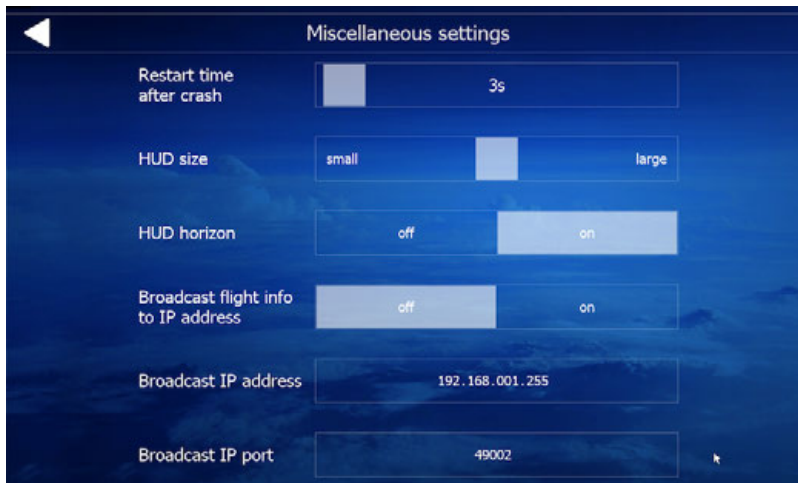

Frasca

Frasca simulators (www.frasca.com) can provide location information to ForeFlight Mobile using the Frasca Upgrade kit, which includes both WiFi and Bluetooth interfaces, as well as the Frasca NorthStar software that provides the simulated GPS position.

The WiFi interface is provided via a wireless router connected to the Frasca FSTD PC, and the Bluetooth interface is provided by a DUAL XGPS160 connected to the FSTD PC by USB cable.

For information about purchase and installation of the upgrade kit in a Frasca simulator, please contact Frasca’s Customer Service Department at (217) 344-9200 or support@frasca.com.

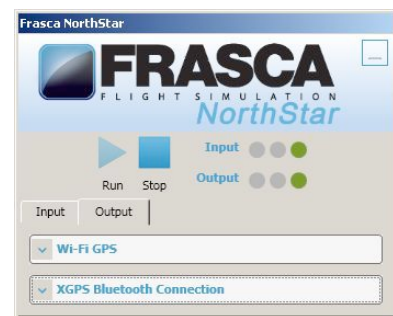

Sharing Flights

To share a flight on Twitter or via Email, create a route in Maps. Bring up the Nav Log, if it is not already showing, and tap the **Send To** button. Then tap either "Twitter" or "Email." Note that Twitter will not be an available option until you configure your twitter account in the main iPad Settings app. Twitter is also only available on iOS 5 and higher.

Twitter

Tapping the Twitter option will present a window similar to that shown below. Edit the text as desired and press Send to create the tweet.

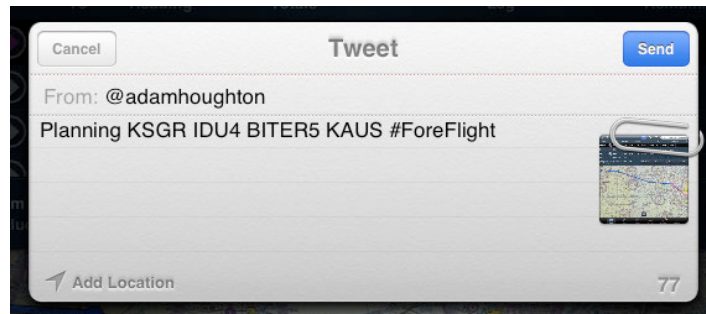

Email

Tapping the email option will show a view like that seen below. Provide the email address of the recipient and tap Send. Note that the email will include a link that other ForeFlight Customers can tap to open the route on their own iPad or iPhone.

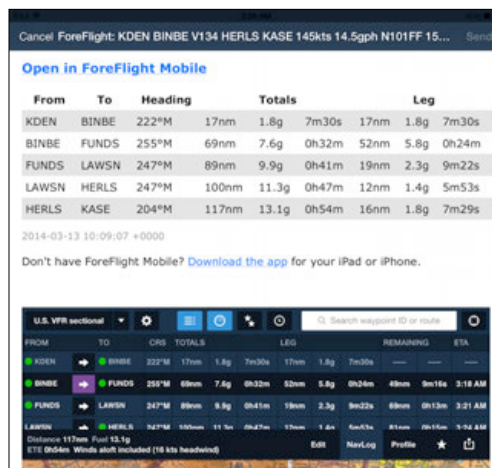

Weather Legends

Radar Legends (when from Internet)

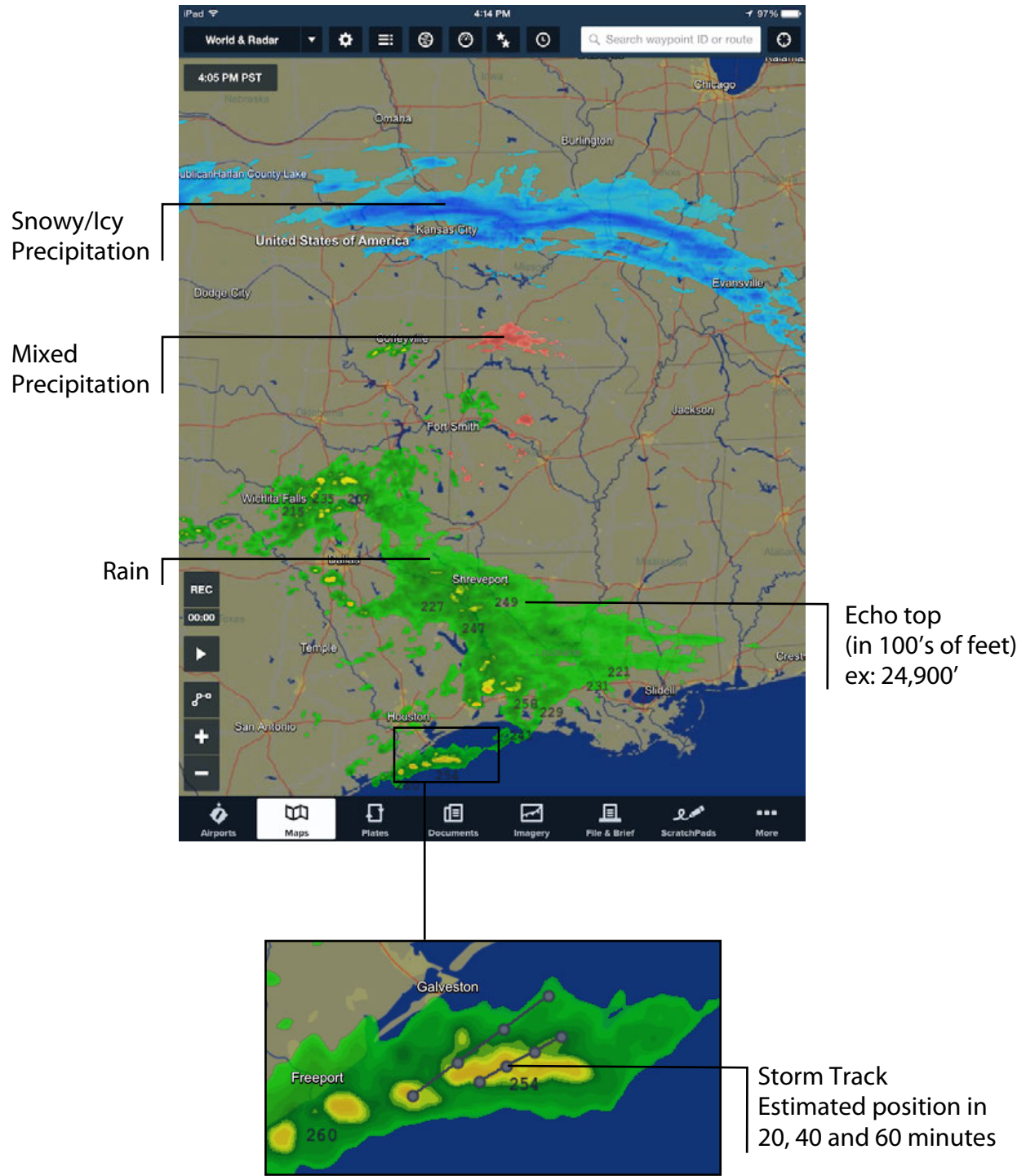

Rain - Radar Intensity (dBZ) vs. Color

Based on RGB values assigned to dBZ range(s)

dBZ	Internet Color ¹	ADS-B Color ^{2,3}	SiriusXM Color ³
5		none shown	none shown
10			
15			
20			
25			
30			
35			
40			
45			
50			
55			
60			
65			
70			
75			
95			

1. Colors are interpolated between levels when rendered on an image.
2. ADS-B (FIS-B) NEXRAD radar is displayed with 6 intensity ranges.
3. Some dBZ intensity/color divisions do not fall exactly on 5 dBZ lines, so are shown as close as possible to specification.

Mixed Rain/Snow - Radar Intensity (dBZ) vs. Color

Based on RGB values assigned to dBZ range(s)

dBZ	Internet Color ¹	ADS-B Color ^{2,3,4}	SiriusXM Color ⁴
5		none shown	none shown
10			
15			
20			
25			
30			
35			
40			
45			
50			
55			
60			
65			
70			
75			

1. Colors are interpolated between levels when rendered on an image.
2. ADS-B (FIS-B) NEXRAD radar is displayed with 6 intensity ranges.
3. FIS-B NEXRAD doesn't include precipitation type, so "Mixed" is displayed at the same reflectivity colors as rain. See AIM Chapter 7: <http://tfmlearning.fly.faa.gov/publications/atpubs/aim/chap7/aim0701.html>
4. Some dBZ intensity/color divisions do not fall exactly on 5 dBZ lines, so are shown as close as possible to specification.

Snow - Radar Intensity (dBZ) vs. Color

Based on RGB values assigned to dBZ range(s)

dBZ	Internet Color ¹	ADS-B Color ^{2,3,4}	SiriusXM Color ⁴
5		none shown	none shown
10			
15			
20			
25			
30			
35			
40			
45			
50			
55			
60			
65			
70			

1. Colors are interpolated between levels when rendered on an image.
2. ADS-B (FIS-B) NEXRAD radar is displayed with 6 intensity ranges.
3. FIS-B NEXRAD doesn't include precipitation type, so "Snow" is displayed at the same reflectivity colors as rain. See AIM Chapter 7: <http://tfmlearning.fly.faa.gov/publications/atpubs/aim/chap7/aim0701.html>
4. Some dBZ intensity/color divisions do not fall exactly on 5 dBZ lines, so are shown as close as possible to specification.

Four-color Radar - Radar Intensity (dBZ) vs. Color

Based on RGB values assigned to dBZ range(s)

dBZ	Internet Color	ADS-B Color	SiriusXM Color ¹
5	none shown	none shown	none shown
10	Green		
15			
20			
25			
30	Yellow	Green	Green
35			
40	Red	Yellow	Yellow
45			
50	Magenta	Red	Red
55			
60			
65			
70			
75			
95			

1. Baron Mobile Link/WXWorx radar does not display in 4-color mode. Only available with SiriusXM when using the SXAR1 [receiver](#).



Baron Mobile Link/WXWorx XM Radar Intensity (dBZ) vs. Color

Based on RGB values assigned to dBZ range(s)

dBZ	Rain	Mixed Rain/Snow	Snow
5	none shown	none shown	none shown
10	Green	Light Purple	Grey
15			
20	Dark Green	Light Purple	Grey
25			
30	Yellow	Light Purple	Grey
35			
40	Orange	Light Purple	Light Grey
45			
50	Red	Light Purple	White
55			
60	Red	Light Pink	Light Blue
65			
70	Purple	Light Purple	Light Blue
75			
95		none shown	none shown





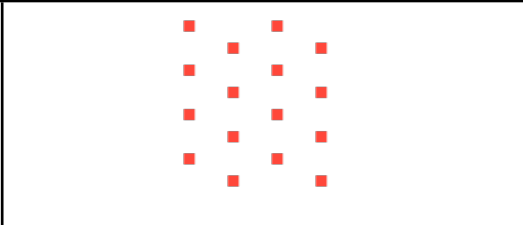



1. Some Baron Mobile Link/WXWorx XM dBZ intensity/color divisions do not fall exactly on 5 dBZ lines, so are shown as close as possible to specification.

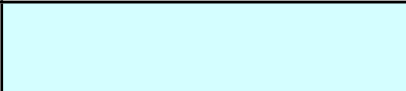



Icing Legend (Internet & SXAR1)

Icing Intensity	Color
Trace, Light	
Moderate	
Heavy, Severe	
SLD Threat (SXAR1 only)	

Note: SLD (supercooled large droplets) Threat indicates the potential presence of large droplets of sub-freezing liquid water, which present a more serious icing hazard than standard icing conditions. See [this page](#) for more information on SLD.

Turbulence Legends

Internet Turbulence	
EDR Intensity	Color
10	
20	
30	
40	
50	
60	
70	
80	
90	

SXAR1 Turbulence	
Turbulence Intensity	Color
Light	
Moderate	
Severe	
Extreme	

Turbulence intensity is ultimately based on EDR (eddy dissipation rate), a measure of how quickly the atmosphere is releasing energy; however, how this numerical value translates into inflight turbulence intensity depends on a given aircraft's weight.

The internet turbulence layer provides an objective (forecast) measure of EDR which will need to be interpreted in the context of a given aircraft's weight category to arrive at an actual turbulence intensity. The SXAR1 turbulence layer, on the other hand, assumes a **medium** aircraft weight category and provides actual turbulence intensity for aircraft in that category; smaller aircraft will experience more severe turbulence at a given intensity and larger aircraft will experience less severe turbulence.

The following graphics correlating EDR with turbulence intensity for each weight category can be used as a rough guide:

Light Aircraft (takeoff weight of 15,500 lbs or less)

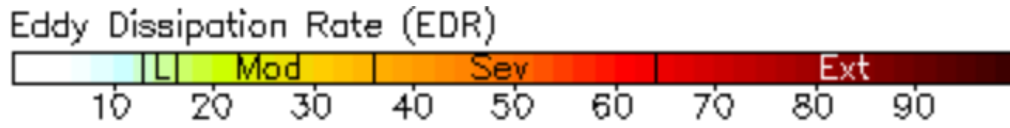



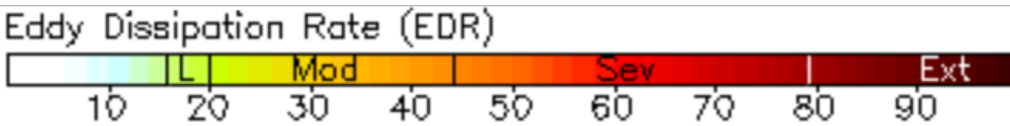



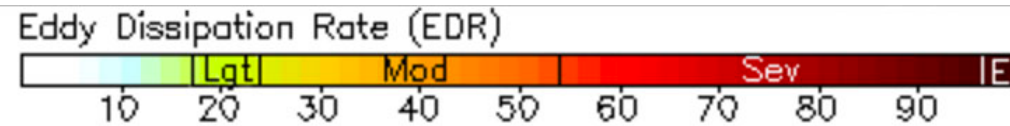



Medium Aircraft (takeoff weight of 15,501 to 299,999 lbs)







Heavy Aircraft (takeoff weight of 300,000 lbs or more)





Surface Analysis Legend (Internet & SXAR1)

Feature	Symbol
Isobars	
Pressure Labels	
High Pressure Centers	
Low Pressure Centers	
Cold Front	
Warm Front	
Occluded Front	
Stationary Front	
Trough	
Squall Line (XM only)	
Dry Line (XM only)	

Radar Legends (when from Internet)

	Lightning (in last 5 minutes)
	Mesocyclone activity (Vortex of rising , rotating air)
	Tornado
	Hail

PIREP Legend

	Icing PIREPs (increasing severity)
	Turbulence PIREPs (increasing severity)
	Sky & Weather PIREP

Enhanced Satellite

The Enhanced Satellite layer uses a combination of visible and infrared satellite imagery to provide a global image of cloud formations.

Visible satellite images are primarily used during daytime and are “enhanced” with infrared highlights for the highest cloud tops. During the night, when visible satellite images are not available, the layer relies entirely on infrared images.

Shades of gray are used to represent the lowest-topped clouds; the darker the shade of gray, the lower the cloud tops.

Above the lightest shades of gray you may see blueish colors representing still colder and higher tops. Above this, shades of yellow, orange and red represent the coldest and highest cloud tops.

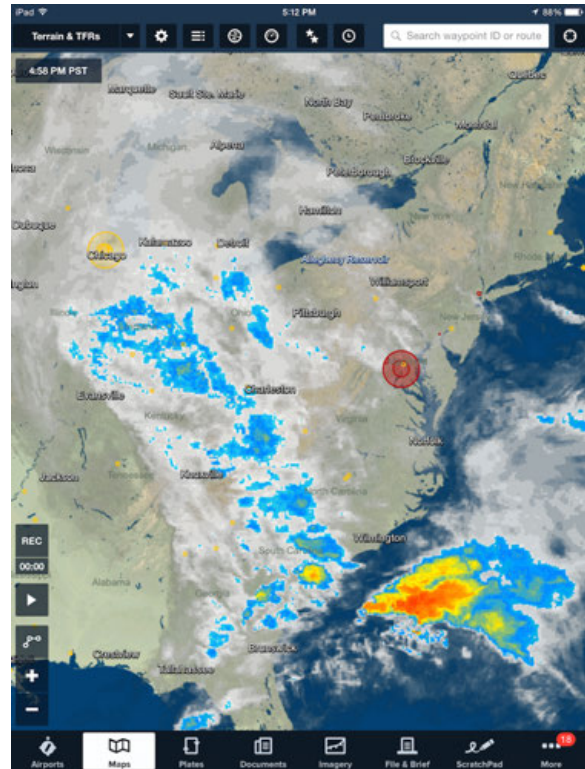











As the temperature of the atmosphere generally decreases with height, a pilot can get a pretty good idea which clouds are high-level and which are low-level based on the color or shades of gray depicted. **Cold cloud tops are often indicative of active thunderstorms that can produce severe or extreme convective turbulence.**

One thing to note is that thick cirrus clouds at very high altitudes will also show up as very cold clouds even though they may not be associated with deep, moist convection. Most of the time these high cirrus clouds do not have the same cellular appearance as convective clouds and thus have very little variation in color.

See the temperatures that correspond to different colors in the table on the next page.

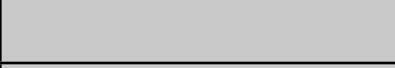
Based on RGB values assigned to temperature range(s)

Temperature °C	Color	Relative Cloud Top Height	
-83		Higher	
-75			
-70			
-65			
-63			
-54			
-50.2			
-50			
-38			
-28			
+12			Lower

Color IR Satellite

Unlike the Enhanced Satellite layer, the Color IR Satellite layer relies solely on infrared satellite imagery to display global cloud coverage, and uses a more refined color scale to represent cloud top temperature.

The IR Satellite layer is a close cousin of the [static color IR satellite images](#) found in the Imagery view. The static images show not only the temperature of the cloud tops using the same colors, but also the temperature of the surface of the earth. This can make it difficult to know where clouds exist and where the sky is clear.

The main improvement of the Color IR Satellite layer over the static images is that it attempts to mask out regions where the sky is clear, showing the map background in those regions instead of the surface temperature.

While this masking algorithm works a majority of the time, it can be difficult to get it right every single time simply using temperature alone. For example, anytime there's a shallow low-topped stratus deck, the tops of the clouds may actually be slightly warmer than the surface of the earth courtesy of a surface-based temperature inversion. So the algorithm may have a difficult time discerning where it is cloudy or clear. It's important to always enable the Sky Coverage layer to pick up on these issues when they occur.

You can learn more about the Color IR Satellite layer and how it can be used to gauge cloud height by reading [this blog post](#) by weather scientist Scott Dennstaedt.

See the temperatures that correspond to different colors in the table on the next page.

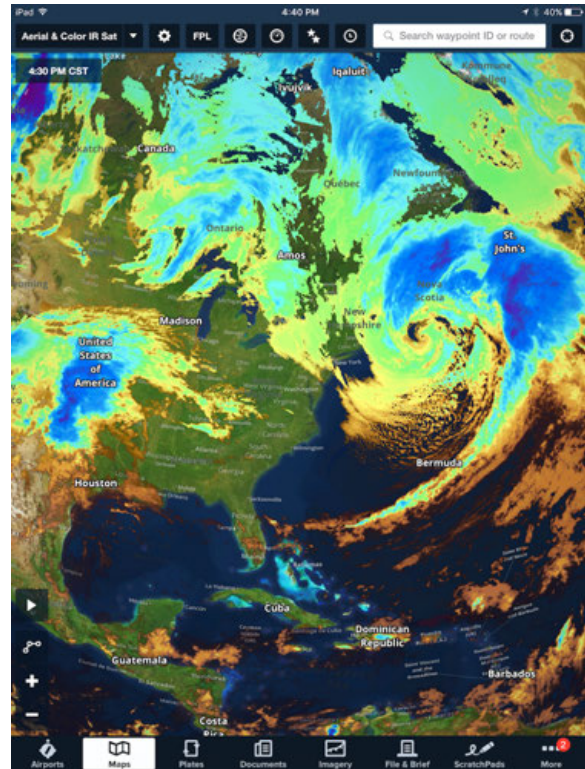

Based on RGB values assigned to temperature range(s)

Temperature °C	Color	Relative Cloud Top Height	
-72		Higher	
-68			
-64			
-60			
-56			
-52			
-48			
-44			
-40			
-36			
-32			
-28			
-24			
-20			
-16			
-12			
-8			
-4			
0			
4			
8			
12			
16			
20			
24			
28			
32			
47	<i>Transparent</i>		Lower

Learning More

To learn even more about ForeFlight Mobile, please visit our website for frequently asked questions (FAQs) and video tutorials.

FAQs: www.foreflight.com/support

Videos: www.foreflight.com/videos

“ForeFlight 101 - Beginner Tutorial” and “ForeFlight 201 - Advanced Course” video presentations: www.foreflight.com/support/training/

To help us at ForeFlight learn more about how you fly, please send any and all feedback on our applications to team@foreflight.com - we read and respond to each note we receive. We also get a kick out of hearing your flying stories, so please do share!

Pilot's Guide Change History

For v9.4 NOTE: REQUIRES iOS 9.2 or LATER

- ❖ Adds support for [Jeppesen global VFR and IFR enroute charts](#) for all customers who have purchased or linked Jeppesen chart coverages. NOTE: Jeppesen enroute charts are not available on iPad Mini 1, iPad 2, iPad 3, and iPhone 5 and earlier.
- ❖ Global [Icing, Turbulence, and Surface Analysis layers](#) are now available on the Maps view for Pro Plus, Performance Plus, and Business Performance subscribers.
- ❖ Administrators of multi-pilot accounts can [“publish” aircraft profiles](#) to all users on an account, improving the efficiency of account management.
- ❖ Customers with a Performance Plus or Business Performance plan can now see a RAIM prediction for routes over the continental U.S., Alaska, and Hawaii, in the Navlog generated on the Flights page. See the Performance Planning in ForeFlight Mobile guide for more information.
- ❖ ForeFlight now integrates with the [Satcom Direct Router](#) to receive GPS and pressure altitude, along with more advanced internet settings for customers on Performance Plus and Business Performance plans.
- ❖ [Avidyne’s IFD 550 FMS](#) can now provide AHRS attitude information to drive ForeFlight attitude indicator and Synthetic Vision.
- ❖ ForeFlight can now connect via Wi-Fi to [uAvionix’s echoUAT and SkyEcho](#) to receive ADS-B weather and traffic and GPS.
- ❖ A new [“Cabin Pressure” instrument](#) has been split off from the existing Pressure Altitude instrument to better differentiate barometric pressure readings from in-cockpit devices vs. devices that provide corrected pressure altitude, such as the Satcom Direct Router.
- ❖ iOS 11 includes a “While Using the App” option in [Privacy > Location Services](#). The recommended setting is still “Always” so that the app can show your position immediately after reopening the app, and so that Track Logs can record in the background.
- ❖ Beginning in iOS 11 the option to share things like Track Logs to Social Media (eg: Twitter, Facebook, etc...) is now included in the “Other” category when you tap the Send To button. iOS versions prior to iOS

11 still have Twitter, Facebook, etc... as separate buttons in the Send To menu.

For v9.3 NOTE: REQUIRES iOS 9.2 or LATER

- ❖ The smallest and most affordable dual-band ADS-B receiver, [Scout](#), is now available to supply inflight weather and traffic in ForeFlight.
- ❖ Time-based weather layers on the Maps view now use a [Time Slider](#) tool that allows for automatic and manual playback of weather timestamps.
- ❖ Pilots who fly with [SiriusXM's SXAR1 aviation weather receiver](#) can now access three new weather layers: Icing, Turbulence, and Surface Analysis.
- ❖ The Maps view has an [improved basemap](#) that shows more roads and railways and includes a new Shaded Terrain option.
- ❖ The Maps view search box now allows you to search for aircraft tail numbers, call signs, and commercial flight numbers to see [scheduled flight plans](#) and load them in ForeFlight.
- ❖ The [Flights view](#) and [Route Advisor](#) now include interactive Route Previews that show your route on an inset map.
- ❖ [Route Advisor](#) will analyze routes that intersect Eurocontrol airspace to determine if they are valid with Eurocontrol's route constraints for filing.
- ❖ The Flights view planning form has a new "[Add Next Flight](#)" button at the bottom to quickly plan consecutive flights on a multi-leg trip.
- ❖ You can now [export your flight plan](#) as a PDF in the official ICAO format using the Send To button at the bottom of the filing form.
- ❖ [Flight Notifications](#) and [Flight Alerts](#) are now turned on for all subscription plan levels, providing all customers with important pre-flight information about their filed flight plans.

For v9.2 NOTE: REQUIRES iOS 9.2 or LATER

- ❖ Adds support for [Jeppesen](#) approach plates, SIDs/STARs, and airport diagrams. Jeppesen charts can be purchased along with a single-pilot ForeFlight Mobile subscription at <https://www.foreflight.com/buy>, or you can link your existing Jeppesen subscription to a single-pilot or multi-pilot ForeFlight account in the app.

- ❖ Adds support for importing georeferenced [User Charts](#) in .mbtiles file format. User charts can be imported via email, hyperlink, AirDrop, and iTunes, and are selected to display on the Maps page like other charts.
- ❖ You can now use [Procedure Advisor](#) to add international departures, arrivals, and approaches to your route.
- ❖ [Logbook](#) Reports now include print-ready Condensed and Complete layouts useful for personal archiving to paper, as well as for job interviews.

For v9.1 NOTE: REQUIRES iOS 9.2 or LATER

- ❖ Introducing ForeFlight Performance Planning, part of the new Performance Plus plan for individuals, and the Business Performance plan for multi-pilot accounts. ForeFlight Performance includes a built-in library of detailed aircraft performance models that produce accurate flight time and fuel burn, a sophisticated flight planning engine that generates valid wind-optimized routes between any two airports in the world, high-fidelity fuel and payload planning, and more – all presented in a user-friendly interface that simplifies planning workflow. See www.foreflight.com/9-1 and the “Performance in ForeFlight” guide in Documents > Catalog > ForeFlight and at <http://foreflight.com/support/performance/pdf> for more details.
- ❖ All subscription levels allow pilots to [create custom Basic performance profiles](#) for their Aircraft.
- ❖ Flights replaces the “File & Brief” view, and adds a streamlined form-based flight planning option, including access to Route Advisor and Altitude Advisor. See [Planning a Flight](#) for an overview, and [Flights](#) for more details.
- ❖ User Waypoints and User Map Layers are now combined in the [User Content](#) section in the More tab. Both types of KML files can also be loaded directly (without using iTunes) and managed inside the app. User Waypoint CSV files are still loaded using iTunes
- ❖ Obstacle and Terrain data is now available worldwide, for the Hazard Advisor and Obstacle layers, and [Synthetic Vision](#). [Download](#) worldwide High Resolution Terrain data via the “Africa, Antarctica, Asia, Australia, Europe, South America” category in More > Downloads.
- ❖ Two-way flight plan transfer is now supported for [Avidyne](#) IFD navigators with firmware 10.2 or later.
- ❖ The Radar (Composite) layer now covers Europe, Australia, and Japan (requires internet connection).

For v9.0.1 NOTE: REQUIRES iOS 9.2 or LATER

- ❖ [User Map Shapes](#) files no longer require the “ffkml” suffix in the filename.
- ❖ Pilots flying with a Garmin [GTX345](#) can now set the Synthetic Vision view “straight & level” (while in level flight) by tapping the AHRS button and choosing “[Zero Pitch & Bank.](#)”

For v9.0 NOTE: REQUIRES iOS 9.2 or LATER

- ❖ [Checklist](#) (included with Plus subscriptions, also available separately) allows you to add and customize checklists using templates for many common GA aircraft.
- ❖ [App Theme](#) lets you pick a “Light” (similar to current) or “Dark” app color-scheme. App Theme does not affect the color of charts, which are still set separately using Color Inversion (see version 8.3 notes below).
- ❖ [Glide Advisor](#)[™] uses your aircraft’s glide ratio, current GPS altitude AGL, surrounding terrain height, and winds aloft (either Packed before your flight, or updated in-flight via ADS-B or SiriusXM) to present a continually-updated ring showing your glide range. IMPORTANT: Prior to use, Glide Advisor must be configured with your aircraft’s best glide speed and glide ratio in More > Aircraft, or in the Maps Settings > Glide Settings.
- ❖ [User Map Shapes](#) allow a pilot to load a KML shape file into the app using iTunes to be displayed on the Maps page. The KML file can include paths, areas, shading, points, etc... and displays independently of the underlying route. NOTE: ForeFlight Track Log KML files cannot currently be displayed as a User Map Shape.
- ❖ When using the SiriusXM SXAR1, [SiriusXM audio channels](#) are now supported; audio is controlled from ForeFlight Mobile and can be played through a Bluetooth device paired with the SXAR1.
- ❖ Microsoft Office [Documents](#) (Word: DOCX, Excel: XLSX, and PowerPoint: PPTX) can now be imported for viewing directly in the Documents tab. Microsoft Office documents can be imported via linked Dropbox, Box, or S3 account, or using iTunes. However unlike PDF documents, Microsoft Office documents cannot currently be annotated in ForeFlight Mobile.
- ❖ A [Surface Wind Analysis](#) layer is now available to pilots flying with a SiriusXM SXAR1 weather receiver. This model-based layer shows

predicted surface winds over the next hour in a regularly-spaced, densely-populated grid across the USA, providing a better overall picture of surface winds than the METAR-based Surface Winds which are irregularly spaced due to actual airport locations.

- ❖ The [Device Disconnect Alert](#) is triggered if the Bluetooth or WiFi connection to a wireless device, such as Stratus 2S, a Garmin Flight Stream 210, or a SiriusXM SXAR1, is lost.
- ❖ The [Traffic Pattern Advisor](#) Teardrop traffic pattern entry shape has been refined to represent a more traditional “teardrop” shape.
- ❖ Customers can now use the [ICAO flight plan form](#) to file with VFR (DC SFRA) flight rules and a DVFR flight type.
- ❖ [MGRS coordinates](#) can now be done entered directly; it is no longer necessary to add MGRS@... before the coordinate.
- ❖ For pilots flying in far-northern or southern latitudes or in areas of larger magnetic variation, ForeFlight Mobile now supports entry of both True and Magnetic bearing from Named Fixes, Airports, Nav aids, and User Waypoints in the [Flight Plan and Search boxes](#). For example: LAX/276M/20.
- ❖ AeroFly FS 2 PC flight simulator can now send simulated position data to ForeFlight Mobile.
- ❖ Moved Stratus ADS-B receiver information, SXAR1, and Baron Mobile Linx/WXWorx, to the [ForeFlight Connect](#) section.

For v8.3 NOTE: REQUIRES iOS 9.2 or LATER

- ❖ The Color Inversion setting allows you to invert colors for easier low-light viewing on the [Maps](#), [Plates](#), and [Documents](#) views.
- ❖ The new [Color IR Satellite](#) layer on the Maps view provides a visualization of cloud top temperature that’s helpful for minimizing the risk of airframe icing.
- ❖ SiriusXM’s SXAR1 weather receiver now provides two additional weather layers in ForeFlight: [Echo Tops and Cloud Tops](#).
- ❖ The new [Destination Weather Frequency](#) callout provides you with your destination airport’s ATIS, ASOS, or AWOS frequency as you near the airport.
- ❖ The [Climb Gradient instrument](#) displays your climb performance in feet per nautical mile.

- ❖ Added [MGRS](#) as a default coordinate system, in More > Settings > Unites/Time > Coordinates.